



wwPDB X-ray Structure Validation Summary Report ⓘ

Aug 20, 2023 – 09:33 AM EDT

PDB ID : 2NU9
Title : C123aT Mutant of E. coli Succinyl-CoA Synthetase Orthorhombic Crystal Form
Authors : Fraser, M.E.
Deposited on : 2006-11-08
Resolution : 2.90 Å(reported)

This is a wwPDB X-ray Structure Validation Summary Report for a publicly released PDB entry.

We welcome your comments at validation@mail.wwpdb.org

A user guide is available at

<https://www.wwpdb.org/validation/2017/XrayValidationReportHelp>

with specific help available everywhere you see the ⓘ symbol.

The types of validation reports are described at

<http://www.wwpdb.org/validation/2017/FAQs#types>.

The following versions of software and data (see [references ⓘ](#)) were used in the production of this report:

MolProbity : 4.02b-467
Mogul : 1.8.5 (274361), CSD as541be (2020)
Xtriage (Phenix) : 1.13
EDS : 2.35
buster-report : 1.1.7 (2018)
Percentile statistics : 20191225.v01 (using entries in the PDB archive December 25th 2019)
Refmac : 5.8.0158
CCP4 : 7.0.044 (Gargrove)
Ideal geometry (proteins) : Engh & Huber (2001)
Ideal geometry (DNA, RNA) : Parkinson et al. (1996)
Validation Pipeline (wwPDB-VP) : 2.35

1 Overall quality at a glance

The following experimental techniques were used to determine the structure:

X-RAY DIFFRACTION

The reported resolution of this entry is 2.90 Å.

Percentile scores (ranging between 0-100) for global validation metrics of the entry are shown in the following graphic. The table shows the number of entries on which the scores are based.

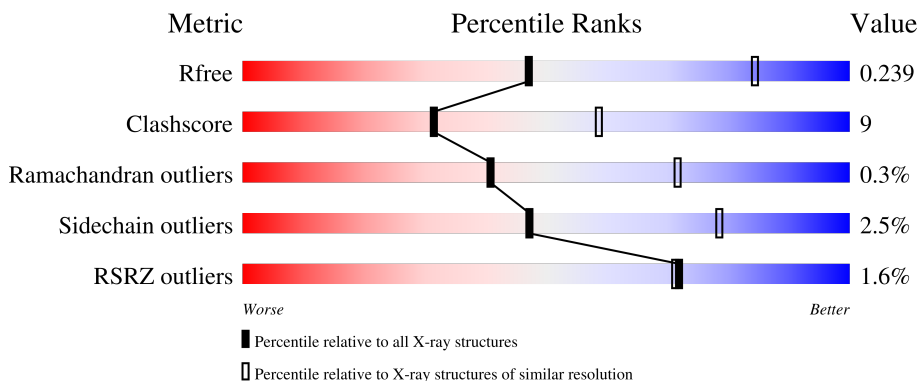



Metric	Whole archive (#Entries)	Similar resolution (#Entries, resolution range(Å))
R_{free}	130704	1957 (2.90-2.90)
Clashscore	141614	2172 (2.90-2.90)
Ramachandran outliers	138981	2115 (2.90-2.90)
Sidechain outliers	138945	2117 (2.90-2.90)
RSRZ outliers	127900	1906 (2.90-2.90)

The table below summarises the geometric issues observed across the polymeric chains and their fit to the electron density. The red, orange, yellow and green segments of the lower bar indicate the fraction of residues that contain outliers for ≥ 3 , 2, 1 and 0 types of geometric quality criteria respectively. A grey segment represents the fraction of residues that are not modelled. The numeric value for each fraction is indicated below the corresponding segment, with a dot representing fractions $\leq 5\%$. The upper red bar (where present) indicates the fraction of residues that have poor fit to the electron density. The numeric value is given above the bar.

Mol	Chain	Length	Quality of chain
1	A	288	83% 15% ..
1	D	288	79% 19% ..
1	F	288	81% 18% ..
1	H	288	77% 20% ..
2	B	388	3% 79% 19% ..

Continued on next page...

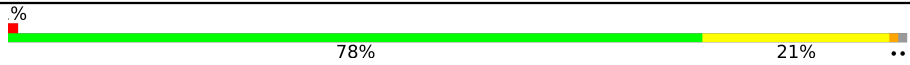
Continued from previous page...

Mol	Chain	Length	Quality of chain	
2	E	388		..
2	G	388		..
2	I	388		..

The following table lists non-polymeric compounds, carbohydrate monomers and non-standard residues in protein, DNA, RNA chains that are outliers for geometric or electron-density-fit criteria:

Mol	Type	Chain	Res	Chirality	Geometry	Clashes	Electron density
4	SO4	I	389	-	-	-	X

2 Entry composition

There are 5 unique types of molecules in this entry. The entry contains 20040 atoms, of which 0 are hydrogens and 0 are deuteriums.

In the tables below, the ZeroOcc column contains the number of atoms modelled with zero occupancy, the AltConf column contains the number of residues with at least one atom in alternate conformation and the Trace column contains the number of residues modelled with at most 2 atoms.

- Molecule 1 is a protein called Succinyl-CoA ligase [ADP-forming] subunit alpha.

Mol	Chain	Residues	Atoms						ZeroOcc	AltConf	Trace
			Total	C	N	O	P	S			
1	A	286	2066	1308	345	402	1	10	0	0	0
1	D	286	2066	1308	345	402	1	10	0	0	0
1	F	286	2066	1308	345	402	1	10	0	0	0
1	H	286	2066	1308	345	402	1	10	0	0	0

There are 8 discrepancies between the modelled and reference sequences:

Chain	Residue	Modelled	Actual	Comment	Reference
A	123	THR	CYS	engineered mutation	UNP P0AGE9
A	246	NEP	HIS	modified residue	UNP P0AGE9
D	123	THR	CYS	engineered mutation	UNP P0AGE9
D	246	NEP	HIS	modified residue	UNP P0AGE9
F	123	THR	CYS	engineered mutation	UNP P0AGE9
F	246	NEP	HIS	modified residue	UNP P0AGE9
H	123	THR	CYS	engineered mutation	UNP P0AGE9
H	246	NEP	HIS	modified residue	UNP P0AGE9

- Molecule 2 is a protein called Succinyl-CoA synthetase beta chain.

Mol	Chain	Residues	Atoms					ZeroOcc	AltConf	Trace
			Total	C	N	O	S			
2	B	385	2885	1823	505	544	13	0	0	0
2	E	385	2885	1823	505	544	13	0	0	0
2	G	385	2885	1823	505	544	13	0	0	0
2	I	385	2885	1823	505	544	13	0	0	0

- Molecule 3 is COENZYME A (three-letter code: COA) (formula: $C_{21}H_{36}N_7O_{16}P_3S$).

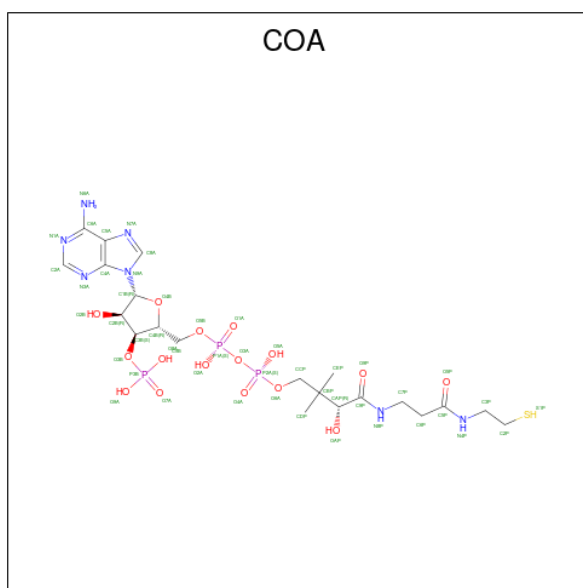

Mol	Chain	Residues	Atoms					ZeroOcc	AltConf	
			Total	C	N	O	P			S
3	A	1	Total	C	N	O	P	S	0	0
			48	21	7	16	3	1		
3	D	1	Total	C	N	O	P	S	0	0
			48	21	7	16	3	1		
3	F	1	Total	C	N	O	P	S	0	0
			48	21	7	16	3	1		
3	H	1	Total	C	N	O	P	S	0	0
			48	21	7	16	3	1		

- Molecule 4 is SULFATE ION (three-letter code: SO4) (formula: O_4S).

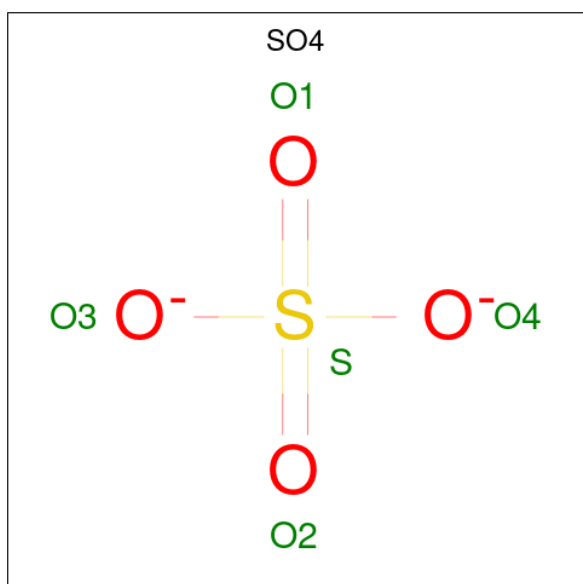

Mol	Chain	Residues	Atoms	ZeroOcc	AltConf
4	B	1	Total O S 5 4 1	0	0
4	B	1	Total O S 5 4 1	0	0
4	E	1	Total O S 5 4 1	0	0
4	E	1	Total O S 5 4 1	0	0
4	G	1	Total O S 5 4 1	0	0
4	G	1	Total O S 5 4 1	0	0
4	I	1	Total O S 5 4 1	0	0
4	I	1	Total O S 5 4 1	0	0

- Molecule 5 is water.

Mol	Chain	Residues	Atoms	ZeroOcc	AltConf
5	A	1	Total O 1 1	0	0
5	E	1	Total O 1 1	0	0
5	F	1	Total O 1 1	0	0
5	H	1	Total O 1 1	0	0

3 Residue-property plots [i](#)

These plots are drawn for all protein, RNA, DNA and oligosaccharide chains in the entry. The first graphic for a chain summarises the proportions of the various outlier classes displayed in the second graphic. The second graphic shows the sequence view annotated by issues in geometry and electron density. Residues are color-coded according to the number of geometric quality criteria for which they contain at least one outlier: green = 0, yellow = 1, orange = 2 and red = 3 or more. A red dot above a residue indicates a poor fit to the electron density ($RSRZ > 2$). Stretches of 2 or more consecutive residues without any outlier are shown as a green connector. Residues present in the sample, but not in the model, are shown in grey.

- Molecule 1: Succinyl-CoA ligase [ADP-forming] subunit alpha

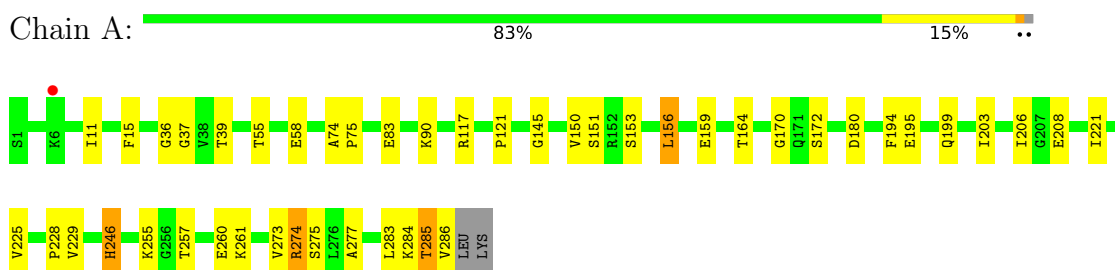

- Molecule 1: Succinyl-CoA ligase [ADP-forming] subunit alpha

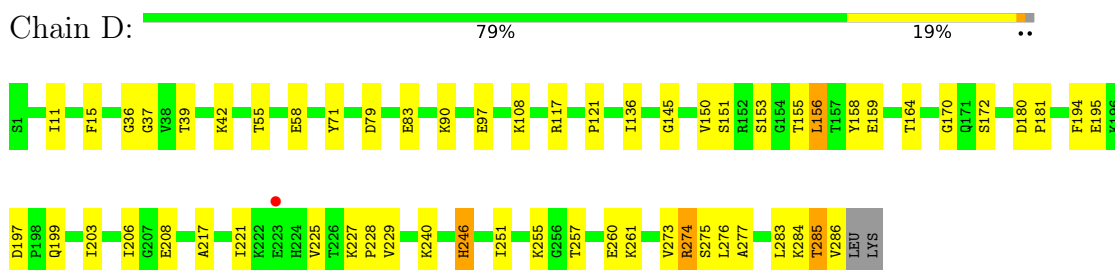

- Molecule 1: Succinyl-CoA ligase [ADP-forming] subunit alpha

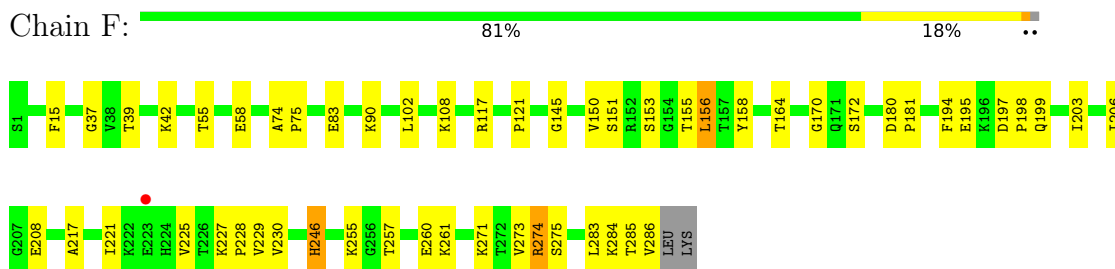

- Molecule 1: Succinyl-CoA ligase [ADP-forming] subunit alpha

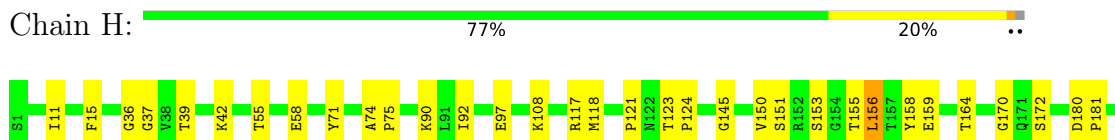

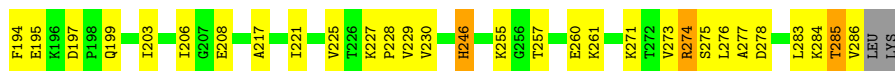

- Molecule 2: Succinyl-CoA synthetase beta chain

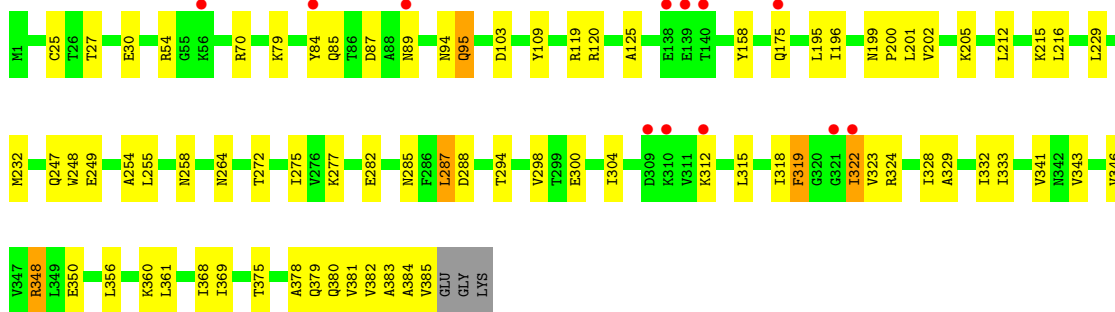
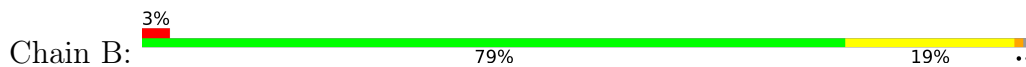

- Molecule 2: Succinyl-CoA synthetase beta chain

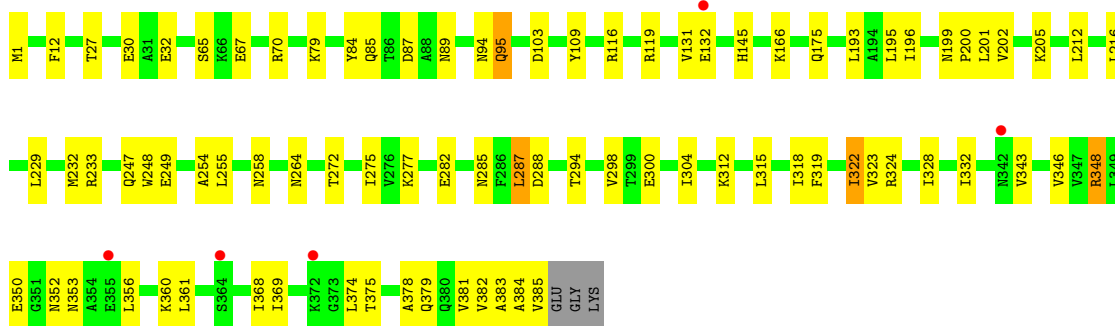
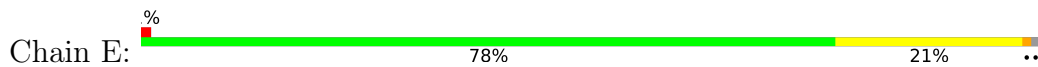

- Molecule 2: Succinyl-CoA synthetase beta chain

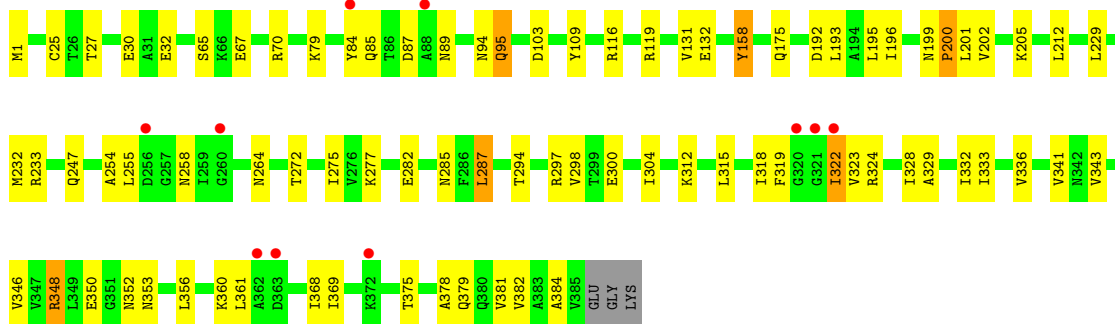
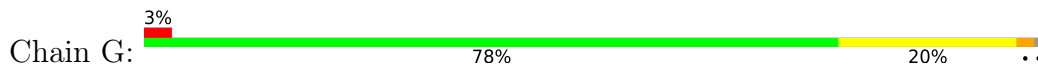

- Molecule 2: Succinyl-CoA synthetase beta chain

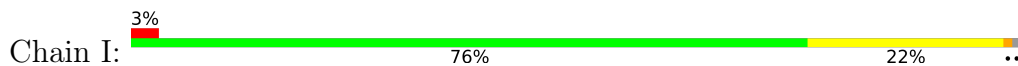

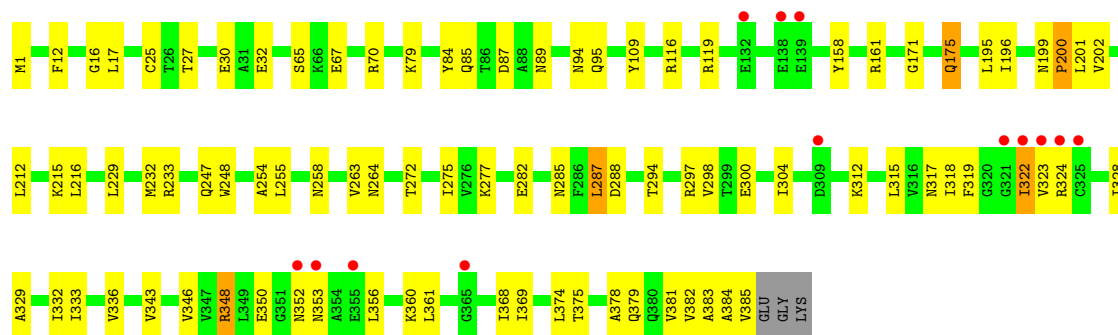

4 Data and refinement statistics

Property	Value	Source
Space group	P 21 21 21	Depositor
Cell constants a, b, c, α , β , γ	98.53Å 154.90Å 240.62Å 90.00° 90.00° 90.00°	Depositor
Resolution (Å)	20.11 – 2.90 20.10 – 2.90	Depositor EDS
% Data completeness (in resolution range)	98.3 (20.11-2.90) 98.6 (20.10-2.90)	Depositor EDS
R_{merge}	0.12	Depositor
R_{sym}	(Not available)	Depositor
$\langle I/\sigma(I) \rangle$ ¹	1.67 (at 2.88Å)	Xtrriage
Refinement program	CNS 1.1	Depositor
R, R_{free}	0.229 , 0.251 0.219 , 0.239	Depositor DCC
R_{free} test set	4125 reflections (5.10%)	wwPDB-VP
Wilson B-factor (Å ²)	44.8	Xtrriage
Anisotropy	0.511	Xtrriage
Bulk solvent k_{sol} (e/Å ³), B_{sol} (Å ²)	0.33 , 33.0	EDS
L-test for twinning ²	$\langle L \rangle = 0.50$, $\langle L^2 \rangle = 0.33$	Xtrriage
Estimated twinning fraction	No twinning to report.	Xtrriage
F_o, F_c correlation	0.91	EDS
Total number of atoms	20040	wwPDB-VP
Average B, all atoms (Å ²)	38.0	wwPDB-VP

Xtrriage's analysis on translational NCS is as follows: *The largest off-origin peak in the Patterson function is 2.17% of the height of the origin peak. No significant pseudotranslation is detected.*

¹Intensities estimated from amplitudes.

²Theoretical values of $\langle |L| \rangle$, $\langle L^2 \rangle$ for acentric reflections are 0.5, 0.333 respectively for untwinned datasets, and 0.375, 0.2 for perfectly twinned datasets.

5 Model quality [i](#)

5.1 Standard geometry [i](#)

Bond lengths and bond angles in the following residue types are not validated in this section: NEP, COA, SO4

The Z score for a bond length (or angle) is the number of standard deviations the observed value is removed from the expected value. A bond length (or angle) with $|Z| > 5$ is considered an outlier worth inspection. RMSZ is the root-mean-square of all Z scores of the bond lengths (or angles).

Mol	Chain	Bond lengths		Bond angles	
		RMSZ	# Z >5	RMSZ	# Z >5
1	A	0.41	0/2084	0.63	0/2822
1	D	0.40	0/2084	0.64	0/2822
1	F	0.41	0/2084	0.64	0/2822
1	H	0.41	0/2084	0.64	0/2822
2	B	0.43	0/2927	0.62	1/3961 (0.0%)
2	E	0.42	0/2927	0.61	1/3961 (0.0%)
2	G	0.42	0/2927	0.61	1/3961 (0.0%)
2	I	0.42	0/2927	0.61	1/3961 (0.0%)
All	All	0.42	0/20044	0.62	4/27132 (0.0%)

There are no bond length outliers.

All (4) bond angle outliers are listed below:

Mol	Chain	Res	Type	Atoms	Z	Observed(°)	Ideal(°)
2	B	201	LEU	N-CA-C	-5.53	96.08	111.00
2	G	201	LEU	N-CA-C	-5.22	96.90	111.00
2	I	201	LEU	N-CA-C	-5.07	97.32	111.00
2	E	201	LEU	N-CA-C	-5.01	97.47	111.00

There are no chirality outliers.

There are no planarity outliers.

5.2 Too-close contacts [i](#)

In the following table, the Non-H and H(model) columns list the number of non-hydrogen atoms and hydrogen atoms in the chain respectively. The H(added) column lists the number of hydrogen atoms added and optimized by MolProbity. The Clashes column lists the number of clashes within the asymmetric unit, whereas Symm-Clashes lists symmetry-related clashes.

Mol	Chain	Non-H	H(model)	H(added)	Clashes	Symm-Clashes
1	A	2066	0	2118	29	0
1	D	2066	0	2118	42	0
1	F	2066	0	2118	36	0
1	H	2066	0	2118	42	0
2	B	2885	0	2941	61	0
2	E	2885	0	2941	60	0
2	G	2885	0	2941	58	0
2	I	2885	0	2941	64	0
3	A	48	0	32	1	0
3	D	48	0	32	5	0
3	F	48	0	32	0	0
3	H	48	0	32	3	0
4	B	10	0	0	1	0
4	E	10	0	0	0	0
4	G	10	0	0	0	0
4	I	10	0	0	0	0
5	A	1	0	0	0	0
5	E	1	0	0	0	0
5	F	1	0	0	0	0
5	H	1	0	0	0	0
All	All	20040	0	20364	365	0

The all-atom clashscore is defined as the number of clashes found per 1000 atoms (including hydrogen atoms). The all-atom clashscore for this structure is 9.

The worst 5 of 365 close contacts within the same asymmetric unit are listed below, sorted by their clash magnitude.

Atom-1	Atom-2	Interatomic distance (Å)	Clash overlap (Å)
2:I:322:ILE:HD13	2:I:322:ILE:H	1.29	0.97
2:E:322:ILE:HD13	2:E:322:ILE:H	1.26	0.97
2:G:322:ILE:HD13	2:G:322:ILE:H	1.27	0.96
2:B:322:ILE:HD13	2:B:322:ILE:H	1.31	0.94
2:E:315:LEU:HB2	2:E:381:VAL:HG11	1.56	0.87

There are no symmetry-related clashes.

5.3 Torsion angles [i](#)

5.3.1 Protein backbone [i](#)

In the following table, the Percentiles column shows the percent Ramachandran outliers of the chain as a percentile score with respect to all X-ray entries followed by that with respect to entries of similar resolution.

The Analysed column shows the number of residues for which the backbone conformation was analysed, and the total number of residues.

Mol	Chain	Analysed	Favoured	Allowed	Outliers	Percentiles	
1	A	283/288 (98%)	272 (96%)	10 (4%)	1 (0%)	34	66
1	D	283/288 (98%)	271 (96%)	11 (4%)	1 (0%)	34	66
1	F	283/288 (98%)	271 (96%)	12 (4%)	0	100	100
1	H	283/288 (98%)	271 (96%)	11 (4%)	1 (0%)	34	66
2	B	383/388 (99%)	373 (97%)	9 (2%)	1 (0%)	41	71
2	E	383/388 (99%)	373 (97%)	9 (2%)	1 (0%)	41	71
2	G	383/388 (99%)	372 (97%)	10 (3%)	1 (0%)	41	71
2	I	383/388 (99%)	373 (97%)	9 (2%)	1 (0%)	41	71
All	All	2664/2704 (98%)	2576 (97%)	81 (3%)	7 (0%)	41	71

5 of 7 Ramachandran outliers are listed below:

Mol	Chain	Res	Type
2	B	384	ALA
2	E	384	ALA
2	G	384	ALA
2	I	384	ALA
1	A	285	THR

5.3.2 Protein sidechains [i](#)

In the following table, the Percentiles column shows the percent sidechain outliers of the chain as a percentile score with respect to all X-ray entries followed by that with respect to entries of similar resolution.

The Analysed column shows the number of residues for which the sidechain conformation was analysed, and the total number of residues.

Mol	Chain	Analysed	Rotameric	Outliers	Percentiles	
1	A	215/217 (99%)	210 (98%)	5 (2%)	50	80

Continued on next page...

Continued from previous page...

Mol	Chain	Analysed	Rotameric	Outliers	Percentiles	
1	D	215/217 (99%)	210 (98%)	5 (2%)	50	80
1	F	215/217 (99%)	210 (98%)	5 (2%)	50	80
1	H	215/217 (99%)	210 (98%)	5 (2%)	50	80
2	B	296/298 (99%)	289 (98%)	7 (2%)	49	79
2	E	296/298 (99%)	289 (98%)	7 (2%)	49	79
2	G	296/298 (99%)	287 (97%)	9 (3%)	41	75
2	I	296/298 (99%)	288 (97%)	8 (3%)	44	77
All	All	2044/2060 (99%)	1993 (98%)	51 (2%)	47	78

5 of 51 residues with a non-rotameric sidechain are listed below:

Mol	Chain	Res	Type
1	F	274	ARG
2	G	319	PHE
2	I	322	ILE
2	G	95	GLN
2	G	200	PRO

Sometimes sidechains can be flipped to improve hydrogen bonding and reduce clashes. 5 of 18 such sidechains are listed below:

Mol	Chain	Res	Type
2	I	94	ASN
2	I	352	ASN
2	I	342	ASN
2	E	352	ASN
2	G	352	ASN

5.3.3 RNA [i](#)

There are no RNA molecules in this entry.

5.4 Non-standard residues in protein, DNA, RNA chains [i](#)

4 non-standard protein/DNA/RNA residues are modelled in this entry.

In the following table, the Counts columns list the number of bonds (or angles) for which Mogul statistics could be retrieved, the number of bonds (or angles) that are observed in the model and the number of bonds (or angles) that are defined in the Chemical Component Dictionary. The

Link column lists molecule types, if any, to which the group is linked. The Z score for a bond length (or angle) is the number of standard deviations the observed value is removed from the expected value. A bond length (or angle) with $|Z| > 2$ is considered an outlier worth inspection. RMSZ is the root-mean-square of all Z scores of the bond lengths (or angles).

Mol	Type	Chain	Res	Link	Bond lengths			Bond angles		
					Counts	RMSZ	# Z > 2	Counts	RMSZ	# Z > 2
1	NEP	H	246	1	10,14,15	1.71	2 (20%)	5,20,22	1.67	1 (20%)
1	NEP	D	246	1	10,14,15	1.60	3 (30%)	5,20,22	1.55	1 (20%)
1	NEP	A	246	1	10,14,15	1.66	2 (20%)	5,20,22	1.49	1 (20%)
1	NEP	F	246	1	10,14,15	1.54	2 (20%)	5,20,22	1.63	1 (20%)

In the following table, the Chirals column lists the number of chiral outliers, the number of chiral centers analysed, the number of these observed in the model and the number defined in the Chemical Component Dictionary. Similar counts are reported in the Torsion and Rings columns. '-' means no outliers of that kind were identified.

Mol	Type	Chain	Res	Link	Chirals	Torsions	Rings
1	NEP	H	246	1	-	1/5/12/14	0/1/1/1
1	NEP	D	246	1	-	1/5/12/14	0/1/1/1
1	NEP	A	246	1	-	1/5/12/14	0/1/1/1
1	NEP	F	246	1	-	1/5/12/14	0/1/1/1

The worst 5 of 9 bond length outliers are listed below:

Mol	Chain	Res	Type	Atoms	Z	Observed(Å)	Ideal(Å)
1	F	246	NEP	P-O1P	-3.64	1.47	1.54
1	H	246	NEP	P-O2P	-3.57	1.47	1.54
1	A	246	NEP	P-O1P	-3.41	1.47	1.54
1	H	246	NEP	P-O1P	-3.33	1.48	1.54
1	A	246	NEP	P-O2P	-3.03	1.48	1.54

All (4) bond angle outliers are listed below:

Mol	Chain	Res	Type	Atoms	Z	Observed(°)	Ideal(°)
1	A	246	NEP	CB-CA-C	-2.26	107.23	111.47
1	D	246	NEP	CB-CA-C	-2.21	107.32	111.47
1	H	246	NEP	CB-CA-C	-2.17	107.40	111.47
1	F	246	NEP	CB-CA-C	-2.11	107.52	111.47

There are no chirality outliers.

All (4) torsion outliers are listed below:

Mol	Chain	Res	Type	Atoms
1	A	246	NEP	CA-CB-CG-CD2
1	D	246	NEP	CA-CB-CG-CD2
1	F	246	NEP	CA-CB-CG-CD2
1	H	246	NEP	CA-CB-CG-CD2

There are no ring outliers.

4 monomers are involved in 4 short contacts:

Mol	Chain	Res	Type	Clashes	Symm-Clashes
1	H	246	NEP	1	0
1	D	246	NEP	1	0
1	A	246	NEP	1	0
1	F	246	NEP	1	0

5.5 Carbohydrates [i](#)

There are no monosaccharides in this entry.

5.6 Ligand geometry [i](#)

12 ligands are modelled in this entry.

In the following table, the Counts columns list the number of bonds (or angles) for which Mogul statistics could be retrieved, the number of bonds (or angles) that are observed in the model and the number of bonds (or angles) that are defined in the Chemical Component Dictionary. The Link column lists molecule types, if any, to which the group is linked. The Z score for a bond length (or angle) is the number of standard deviations the observed value is removed from the expected value. A bond length (or angle) with $|Z| > 2$ is considered an outlier worth inspection. RMSZ is the root-mean-square of all Z scores of the bond lengths (or angles).

Mol	Type	Chain	Res	Link	Bond lengths			Bond angles		
					Counts	RMSZ	$\# Z > 2$	Counts	RMSZ	$\# Z > 2$
4	SO4	I	390	-	4,4,4	0.21	0	6,6,6	0.12	0
4	SO4	B	389	-	4,4,4	0.30	0	6,6,6	0.14	0
4	SO4	B	390	-	4,4,4	0.33	0	6,6,6	0.13	0
4	SO4	G	389	-	4,4,4	0.33	0	6,6,6	0.24	0
4	SO4	E	389	-	4,4,4	0.28	0	6,6,6	0.12	0
3	COA	F	400	-	41,50,50	0.78	0	52,75,75	1.64	9 (17%)
3	COA	H	401	-	41,50,50	0.76	1 (2%)	52,75,75	1.82	9 (17%)
3	COA	A	300	-	41,50,50	0.85	1 (2%)	52,75,75	1.30	5 (9%)
4	SO4	E	390	-	4,4,4	0.21	0	6,6,6	0.07	0
3	COA	D	301	-	41,50,50	0.76	0	52,75,75	1.37	7 (13%)

Mol	Type	Chain	Res	Link	Bond lengths			Bond angles		
					Counts	RMSZ	# Z > 2	Counts	RMSZ	# Z > 2
4	SO4	I	389	-	4,4,4	0.47	0	6,6,6	0.18	0
4	SO4	G	390	-	4,4,4	0.37	0	6,6,6	0.22	0

In the following table, the Chirals column lists the number of chiral outliers, the number of chiral centers analysed, the number of these observed in the model and the number defined in the Chemical Component Dictionary. Similar counts are reported in the Torsion and Rings columns. '2' means no outliers of that kind were identified.

Mol	Type	Chain	Res	Link	Chirals	Torsions	Rings
3	COA	H	401	-	-	5/44/64/64	0/3/3/3
3	COA	F	400	-	-	7/44/64/64	0/3/3/3
3	COA	A	300	-	-	2/44/64/64	0/3/3/3
3	COA	D	301	-	-	4/44/64/64	0/3/3/3

All (2) bond length outliers are listed below:

Mol	Chain	Res	Type	Atoms	Z	Observed(Å)	Ideal(Å)
3	A	300	COA	OAP-CAP	3.13	1.48	1.42
3	H	401	COA	C6P-C5P	2.23	1.55	1.51

The worst 5 of 30 bond angle outliers are listed below:

Mol	Chain	Res	Type	Atoms	Z	Observed(°)	Ideal(°)
3	H	401	COA	C6P-C5P-N4P	6.86	127.97	116.42
3	H	401	COA	O5P-C5P-N4P	-4.58	114.38	123.01
3	F	400	COA	CDP-CBP-CCP	4.50	115.57	108.23
3	H	401	COA	C3P-N4P-C5P	-4.48	114.51	122.84
3	F	400	COA	C2P-C3P-N4P	-3.75	103.73	112.31

There are no chirality outliers.

5 of 18 torsion outliers are listed below:

Mol	Chain	Res	Type	Atoms
3	A	300	COA	C2B-C3B-O3B-P3B
3	F	400	COA	C3B-O3B-P3B-O7A
3	H	401	COA	S1P-C2P-C3P-N4P
3	D	301	COA	C2B-C3B-O3B-P3B
3	H	401	COA	C2B-C3B-O3B-P3B

There are no ring outliers.

4 monomers are involved in 10 short contacts:

Mol	Chain	Res	Type	Clashes	Symm-Clashes
4	B	389	SO4	1	0
3	H	401	COA	3	0
3	A	300	COA	1	0
3	D	301	COA	5	0

The following is a two-dimensional graphical depiction of Mogul quality analysis of bond lengths, bond angles, torsion angles, and ring geometry for all instances of the Ligand of Interest. In addition, ligands with molecular weight > 250 and outliers as shown on the validation Tables will also be included. For torsion angles, if less than 5% of the Mogul distribution of torsion angles is within 10 degrees of the torsion angle in question, then that torsion angle is considered an outlier. Any bond that is central to one or more torsion angles identified as an outlier by Mogul will be highlighted in the graph. For rings, the root-mean-square deviation (RMSD) between the ring in question and similar rings identified by Mogul is calculated over all ring torsion angles. If the average RMSD is greater than 60 degrees and the minimal RMSD between the ring in question and any Mogul-identified rings is also greater than 60 degrees, then that ring is considered an outlier. The outliers are highlighted in purple. The color gray indicates Mogul did not find sufficient equivalents in the CSD to analyse the geometry.

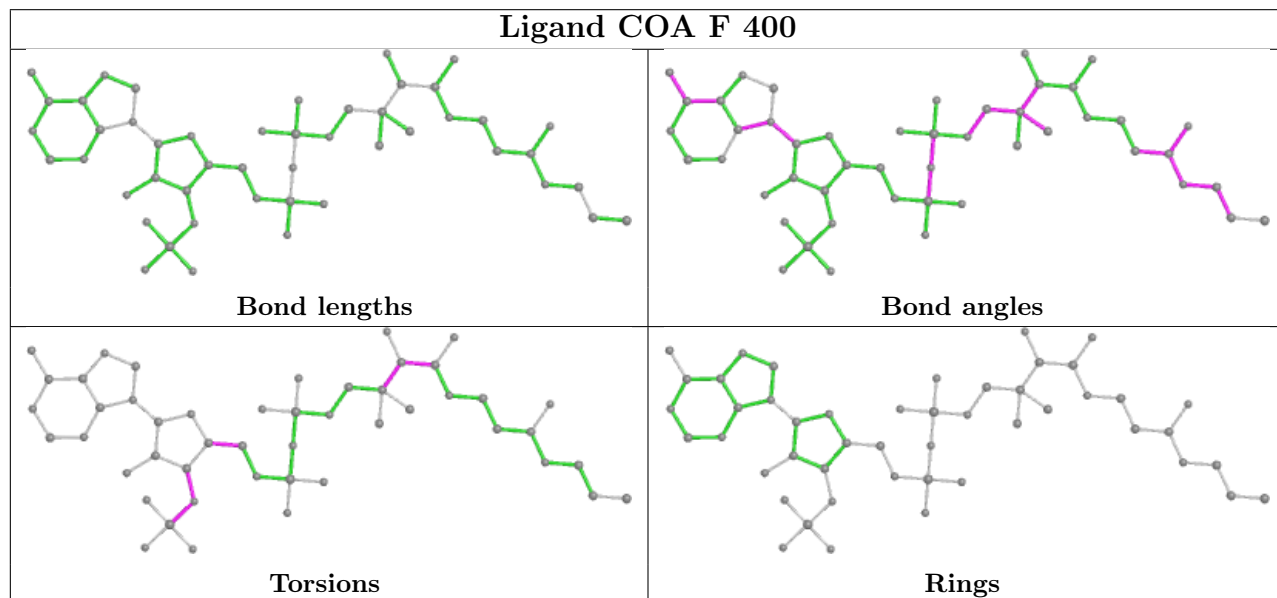

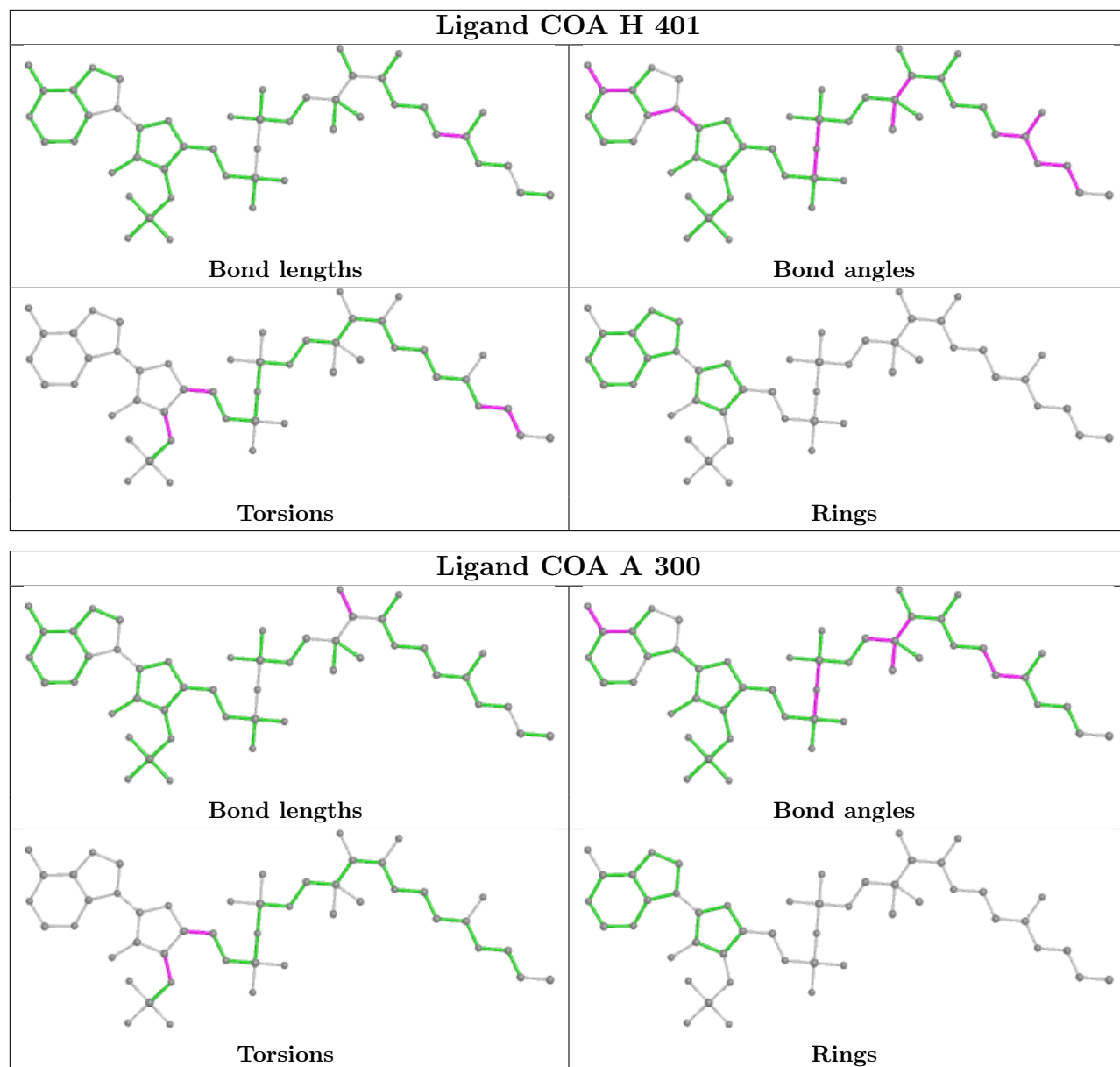

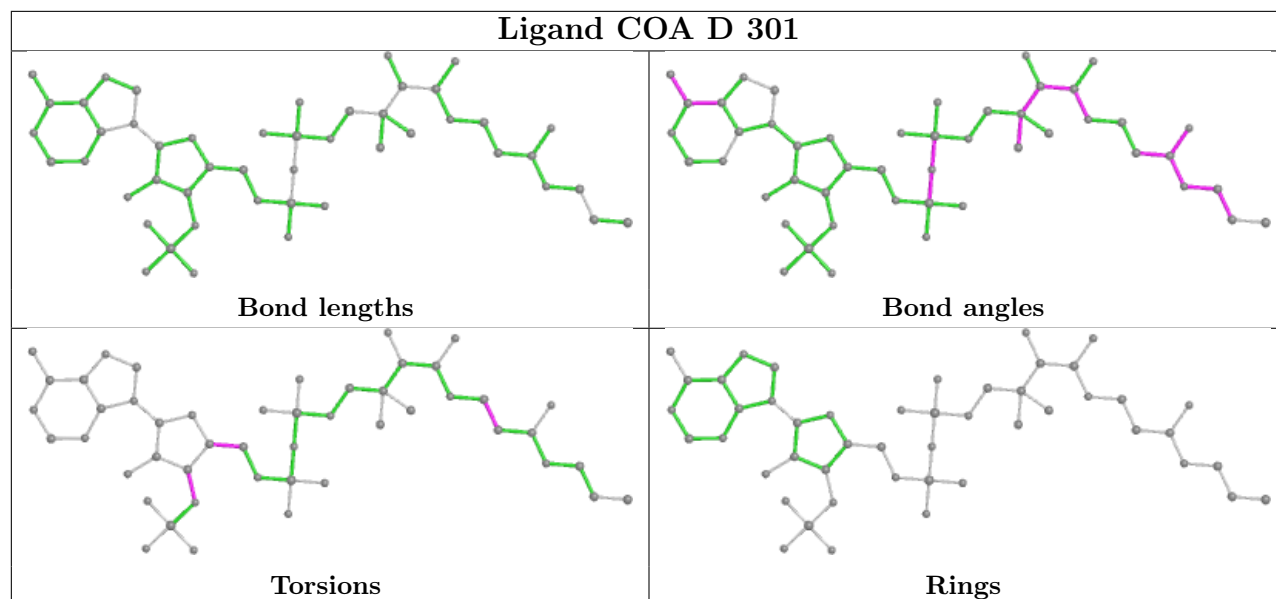

5.7 Other polymers [\(i\)](#)

There are no such residues in this entry.

5.8 Polymer linkage issues [\(i\)](#)

There are no chain breaks in this entry.

6 Fit of model and data [i](#)

6.1 Protein, DNA and RNA chains [i](#)

In the following table, the column labelled ‘#RSRZ> 2’ contains the number (and percentage) of RSRZ outliers, followed by percent RSRZ outliers for the chain as percentile scores relative to all X-ray entries and entries of similar resolution. The OWAB column contains the minimum, median, 95th percentile and maximum values of the occupancy-weighted average B-factor per residue. The column labelled ‘Q< 0.9’ lists the number of (and percentage) of residues with an average occupancy less than 0.9.

Mol	Chain	Analysed	<RSRZ>	#RSRZ>2	OWAB(Å ²)	Q<0.9
1	A	285/288 (98%)	-0.31	1 (0%) 92 93	18, 35, 51, 59	0
1	D	285/288 (98%)	-0.29	1 (0%) 92 93	19, 37, 51, 60	0
1	F	285/288 (98%)	-0.34	1 (0%) 92 93	18, 34, 50, 59	0
1	H	285/288 (98%)	-0.32	0 100 100	19, 36, 51, 60	0
2	B	385/388 (99%)	-0.13	12 (3%) 49 44	18, 36, 64, 79	0
2	E	385/388 (99%)	-0.12	5 (1%) 77 77	19, 37, 64, 78	0
2	G	385/388 (99%)	-0.16	10 (2%) 56 52	19, 37, 64, 78	0
2	I	385/388 (99%)	-0.09	13 (3%) 45 40	19, 37, 65, 79	0
All	All	2680/2704 (99%)	-0.21	43 (1%) 72 71	18, 36, 60, 79	0

The worst 5 of 43 RSRZ outliers are listed below:

Mol	Chain	Res	Type	RSRZ
2	B	322	ILE	6.1
2	I	322	ILE	5.1
2	I	324	ARG	4.1
2	E	132	GLU	3.6
2	I	132	GLU	3.5

6.2 Non-standard residues in protein, DNA, RNA chains [i](#)

In the following table, the Atoms column lists the number of modelled atoms in the group and the number defined in the chemical component dictionary. The B-factors column lists the minimum, median, 95th percentile and maximum values of B factors of atoms in the group. The column labelled ‘Q< 0.9’ lists the number of atoms with occupancy less than 0.9.

Mol	Type	Chain	Res	Atoms	RSCC	RSR	B-factors(Å ²)	Q<0.9
1	NEP	D	246	14/15	0.96	0.13	30,33,38,38	0

Continued on next page...

Continued from previous page...

Mol	Type	Chain	Res	Atoms	RSCC	RSR	B-factors(\AA^2)	Q<0.9
1	NEP	F	246	14/15	0.96	0.12	27,33,34,34	0
1	NEP	A	246	14/15	0.97	0.10	29,32,35,36	0
1	NEP	H	246	14/15	0.98	0.11	29,32,36,36	0

6.3 Carbohydrates [i](#)

There are no monosaccharides in this entry.

6.4 Ligands [i](#)

In the following table, the Atoms column lists the number of modelled atoms in the group and the number defined in the chemical component dictionary. The B-factors column lists the minimum, median, 95th percentile and maximum values of B factors of atoms in the group. The column labelled 'Q< 0.9' lists the number of atoms with occupancy less than 0.9.

Mol	Type	Chain	Res	Atoms	RSCC	RSR	B-factors(\AA^2)	Q<0.9
4	SO4	I	389	5/5	0.72	0.42	68,68,68,69	5
4	SO4	B	389	5/5	0.87	0.24	28,29,30,30	5
4	SO4	G	389	5/5	0.93	0.20	22,23,24,25	5
3	COA	A	300	48/48	0.94	0.16	43,48,52,53	0
4	SO4	B	390	5/5	0.95	0.16	53,53,54,55	0
4	SO4	E	389	5/5	0.95	0.14	28,29,30,31	5
3	COA	F	400	48/48	0.95	0.16	39,45,47,50	0
4	SO4	G	390	5/5	0.95	0.17	68,68,69,69	0
3	COA	D	301	48/48	0.95	0.17	43,46,53,54	0
3	COA	H	401	48/48	0.96	0.15	33,44,58,59	0
4	SO4	I	390	5/5	0.96	0.17	55,56,56,57	0
4	SO4	E	390	5/5	0.98	0.21	56,56,56,56	0

The following is a graphical depiction of the model fit to experimental electron density of all instances of the Ligand of Interest. In addition, ligands with molecular weight > 250 and outliers as shown on the geometry validation Tables will also be included. Each fit is shown from different orientation to approximate a three-dimensional view.

Electron density around COA A 300:

$2mF_o-DF_c$ (at 0.7 rmsd) in gray
 mF_o-DF_c (at 3 rmsd) in purple (negative)
and green (positive)

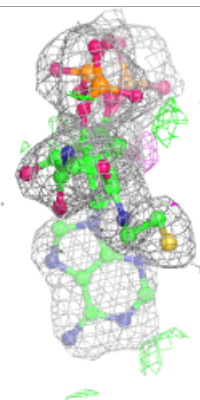
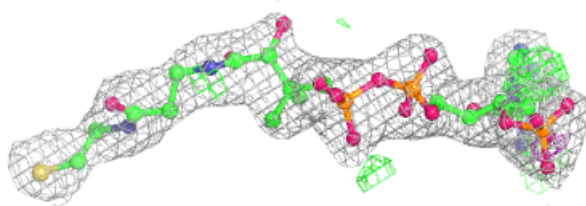
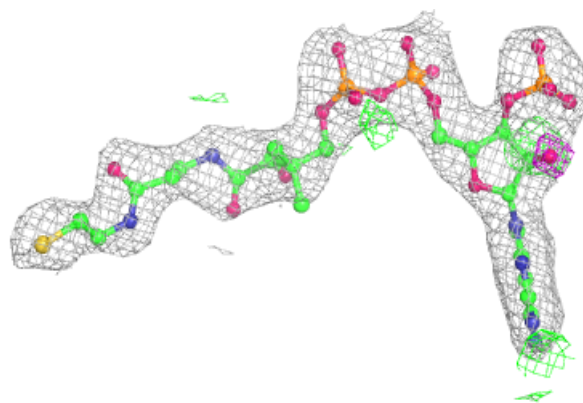
**Electron density around COA F 400:**

$2mF_o-DF_c$ (at 0.7 rmsd) in gray
 mF_o-DF_c (at 3 rmsd) in purple (negative)
and green (positive)

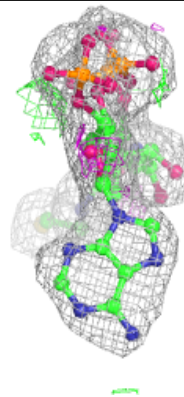
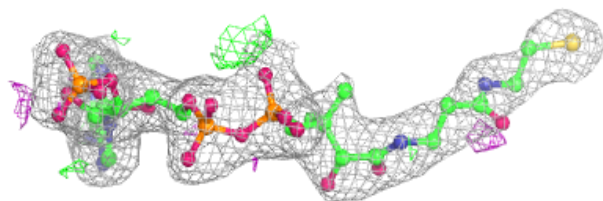
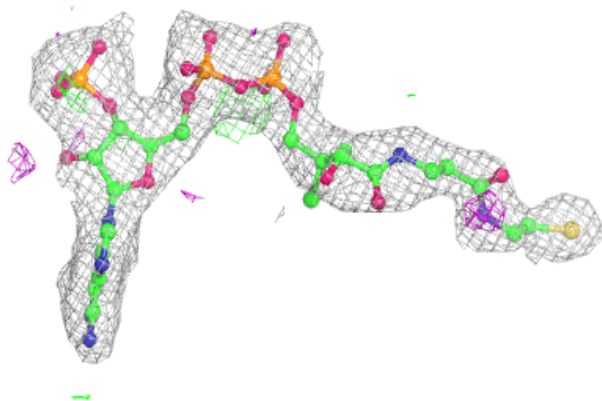

Electron density around COA D 301:

$2mF_o-DF_c$ (at 0.7 rmsd) in gray
 mF_o-DF_c (at 3 rmsd) in purple (negative)
and green (positive)

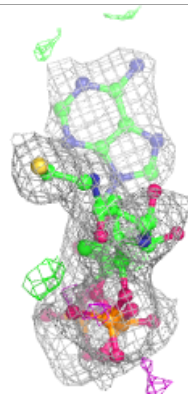
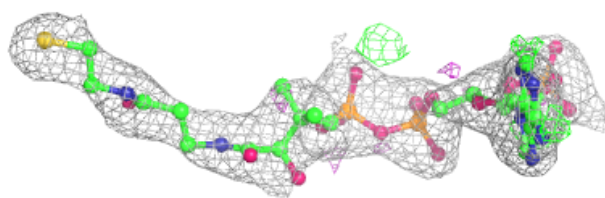
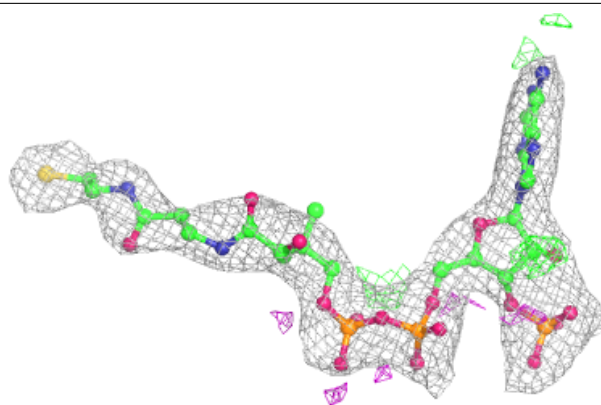
**Electron density around COA H 401:**

$2mF_o-DF_c$ (at 0.7 rmsd) in gray
 mF_o-DF_c (at 3 rmsd) in purple (negative)
and green (positive)

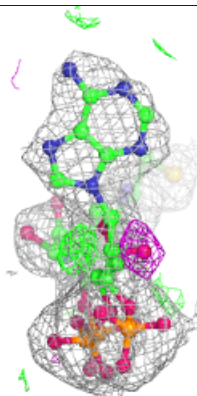
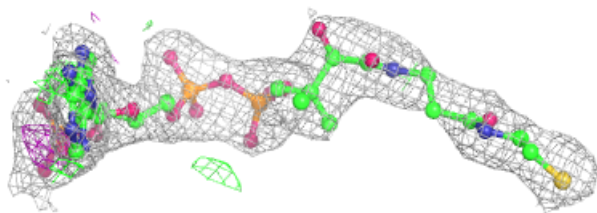
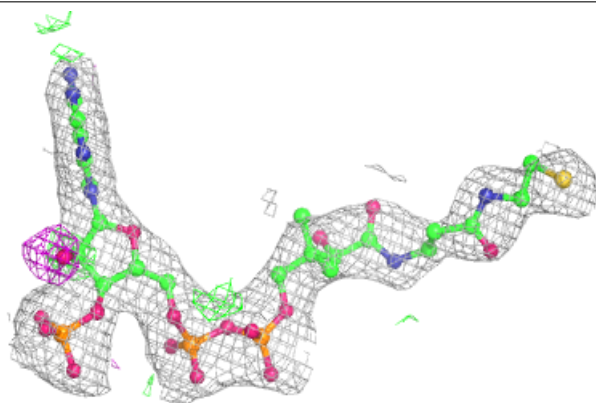

6.5 Other polymers [i](#)

There are no such residues in this entry.