



# wwPDB X-ray Structure Validation Summary Report ⓘ

Jan 4, 2024 – 08:27 pm GMT

PDB ID : 5AHS  
Title : 3-Sulfinopropionyl-Coenzyme A (3SP-CoA) desulfonase from *Advenella mimgardefordensis* DPN7T: holo crystal structure with the substrate analog succinyl-CoA  
Authors : Cianci, M.; Schuermann, M.; Meijers, R.; Schneider, T.R.; Steinbuechel, A.  
Deposited on : 2015-02-06  
Resolution : 2.30 Å(reported)

This is a wwPDB X-ray Structure Validation Summary Report for a publicly released PDB entry.

We welcome your comments at [validation@mail.wwpdb.org](mailto:validation@mail.wwpdb.org)

A user guide is available at

<https://www.wwpdb.org/validation/2017/XrayValidationReportHelp>

with specific help available everywhere you see the ⓘ symbol.

The types of validation reports are described at

<http://www.wwpdb.org/validation/2017/FAQs#types>.

---

The following versions of software and data (see [references ⓘ](#)) were used in the production of this report:

MolProbity : 4.02b-467  
Mogul : 1.8.4, CSD as541be (2020)  
Xtriage (Phenix) : 1.13  
EDS : 2.36  
buster-report : 1.1.7 (2018)  
Percentile statistics : 20191225.v01 (using entries in the PDB archive December 25th 2019)  
Refmac : 5.8.0158  
CCP4 : 7.0.044 (Gargrove)  
Ideal geometry (proteins) : Engh & Huber (2001)  
Ideal geometry (DNA, RNA) : Parkinson et al. (1996)  
Validation Pipeline (wwPDB-VP) : 2.36

# 1 Overall quality at a glance

The following experimental techniques were used to determine the structure:

*X-RAY DIFFRACTION*

The reported resolution of this entry is 2.30 Å.

Percentile scores (ranging between 0-100) for global validation metrics of the entry are shown in the following graphic. The table shows the number of entries on which the scores are based.

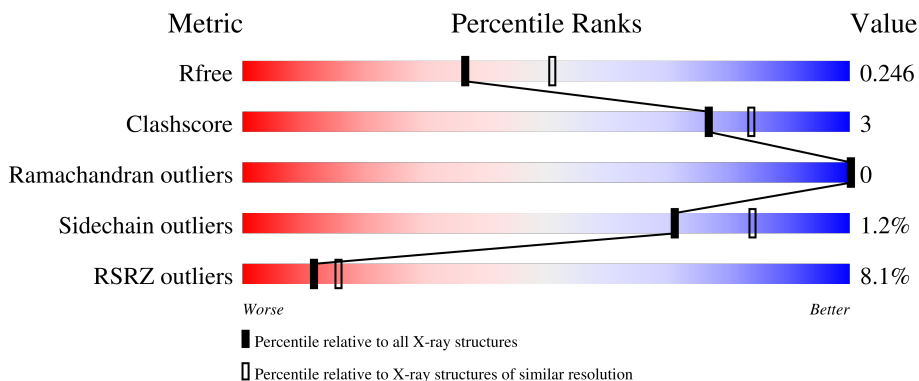

Metric	Whole archive (#Entries)	Similar resolution (#Entries, resolution range(Å))
$R_{free}$	130704	5042 (2.30-2.30)
Clashscore	141614	5643 (2.30-2.30)
Ramachandran outliers	138981	5575 (2.30-2.30)
Sidechain outliers	138945	5575 (2.30-2.30)
RSRZ outliers	127900	4938 (2.30-2.30)

The table below summarises the geometric issues observed across the polymeric chains and their fit to the electron density. The red, orange, yellow and green segments of the lower bar indicate the fraction of residues that contain outliers for  $\geq 3$ , 2, 1 and 0 types of geometric quality criteria respectively. A grey segment represents the fraction of residues that are not modelled. The numeric value for each fraction is indicated below the corresponding segment, with a dot representing fractions  $\leq 5\%$ . The upper red bar (where present) indicates the fraction of residues that have poor fit to the electron density. The numeric value is given above the bar.

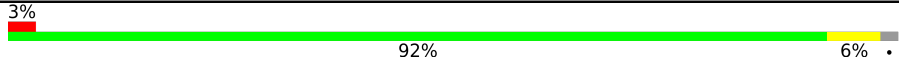
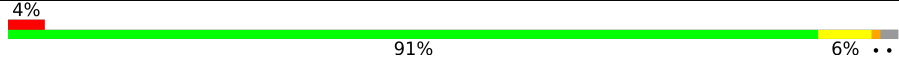
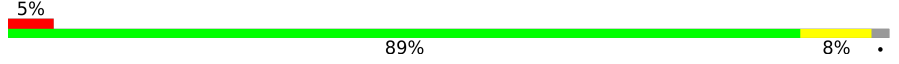
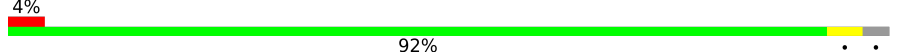
Mol	Chain	Length	Quality of chain
1	A	401	 3% 92% 6% .
1	B	401	 4% 91% 6% ..
1	C	401	 5% 89% 8% .
1	D	401	 4% 92% . .

*Continued on next page...*

*Continued from previous page...*

Mol	Chain	Length	Quality of chain
1	E	401	
1	F	401	

The following table lists non-polymeric compounds, carbohydrate monomers and non-standard residues in protein, DNA, RNA chains that are outliers for geometric or electron-density-fit criteria:

Mol	Type	Chain	Res	Chirality	Geometry	Clashes	Electron density
3	COA	A	411	-	-	-	X

## 2 Entry composition [i](#)

There are 6 unique types of molecules in this entry. The entry contains 19886 atoms, of which 0 are hydrogens and 0 are deuteriums.

In the tables below, the ZeroOcc column contains the number of atoms modelled with zero occupancy, the AltConf column contains the number of residues with at least one atom in alternate conformation and the Trace column contains the number of residues modelled with at most 2 atoms.

- Molecule 1 is a protein called ACYL-COA DEHYDROGENASE.

Mol	Chain	Residues	Atoms					ZeroOcc	AltConf	Trace
			Total	C	N	O	S			
1	A	391	Total 2980	C 1871	N 527	O 563	S 19	0	1	0
1	B	391	Total 2983	C 1872	N 528	O 564	S 19	0	1	0
1	C	391	Total 2974	C 1867	N 526	O 562	S 19	0	0	0
1	D	390	Total 2962	C 1858	N 525	O 560	S 19	0	0	0
1	E	391	Total 2974	C 1867	N 526	O 562	S 19	0	0	0
1	F	391	Total 2980	C 1871	N 527	O 563	S 19	0	1	0

- Molecule 2 is FLAVIN-ADENINE DINUCLEOTIDE (three-letter code: FAD) (formula:  $C_{27}H_{33}N_9O_{15}P_2$ ).

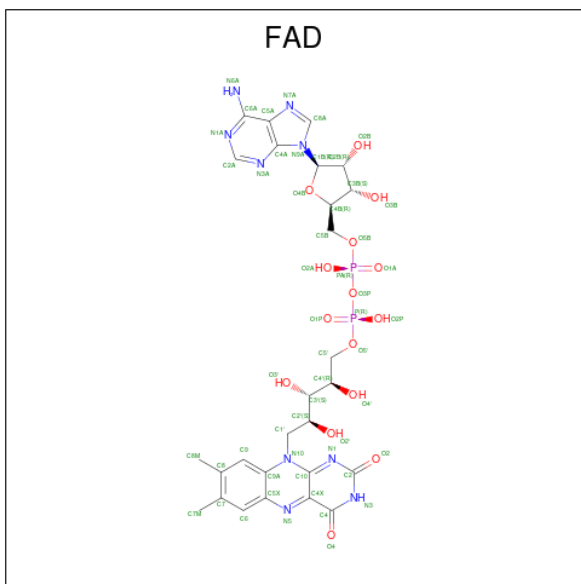

Mol	Chain	Residues	Atoms					ZeroOcc	AltConf
			Total	C	N	O	P		
2	A	1	53	27	9	15	2	0	0
2	B	1	53	27	9	15	2	0	0
2	C	1	53	27	9	15	2	0	0
2	D	1	53	27	9	15	2	0	0
2	E	1	53	27	9	15	2	0	0
2	F	1	53	27	9	15	2	0	0

- Molecule 3 is COENZYME A (three-letter code: COA) (formula:  $C_{21}H_{36}N_7O_{16}P_3S$ ).

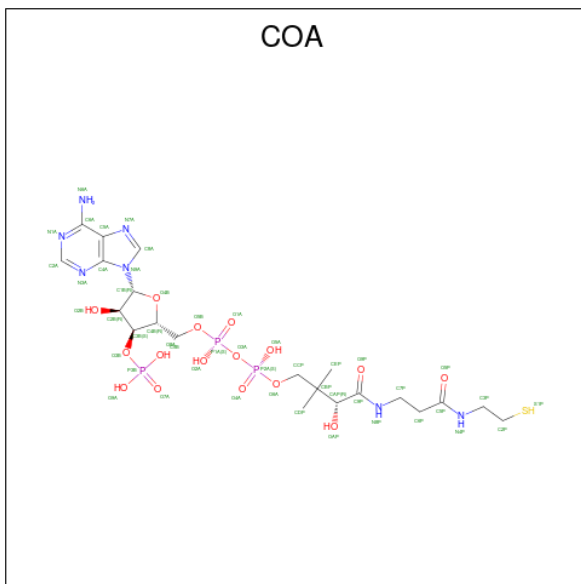

Mol	Chain	Residues	Atoms						ZeroOcc	AltConf
			Total	C	N	O	P	S		
3	A	1	48	21	7	16	3	1	0	0
3	B	1	48	21	7	16	3	1	0	0
3	D	1	48	21	7	16	3	1	0	0
3	E	1	48	21	7	16	3	1	0	0
3	F	1	48	21	7	16	3	1	0	0

- Molecule 4 is SUCCINIC ACID (three-letter code: SIN) (formula:  $C_4H_6O_4$ ).

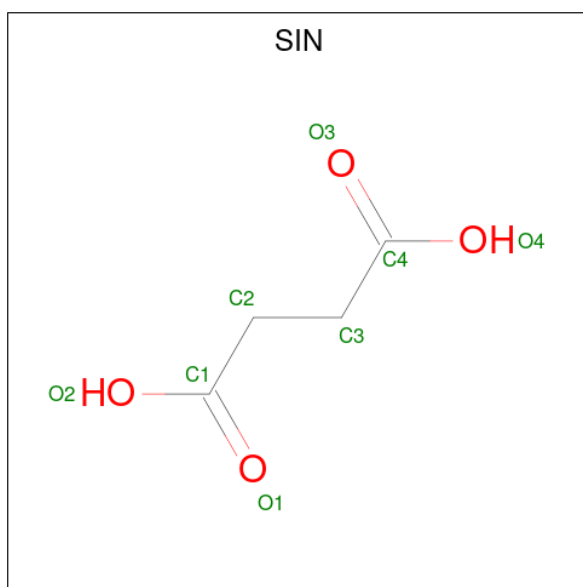

Mol	Chain	Residues	Atoms			ZeroOcc	AltConf
4	C	1	Total	C	O	0	0
			8	4	4		

- Molecule 5 is SULFATE ION (three-letter code: SO<sub>4</sub>) (formula: O<sub>4</sub>S).



Mol	Chain	Residues	Atoms			ZeroOcc	AltConf
5	C	1	Total	O	S	0	0
			5	4	1		

- Molecule 6 is water.

Mol	Chain	Residues	Atoms		ZeroOcc	AltConf
6	A	327	Total 327	O 327	0	0
6	B	271	Total 271	O 271	0	0
6	C	236	Total 236	O 236	0	0
6	D	220	Total 220	O 220	0	0
6	E	203	Total 203	O 203	0	0
6	F	205	Total 205	O 205	0	0

### 3 Residue-property plots

These plots are drawn for all protein, RNA, DNA and oligosaccharide chains in the entry. The first graphic for a chain summarises the proportions of the various outlier classes displayed in the second graphic. The second graphic shows the sequence view annotated by issues in geometry and electron density. Residues are color-coded according to the number of geometric quality criteria for which they contain at least one outlier: green = 0, yellow = 1, orange = 2 and red = 3 or more. A red dot above a residue indicates a poor fit to the electron density ( $RSRZ > 2$ ). Stretches of 2 or more consecutive residues without any outlier are shown as a green connector. Residues present in the sample, but not in the model, are shown in grey.

- Molecule 1: ACYL-COA DEHYDROGENASE

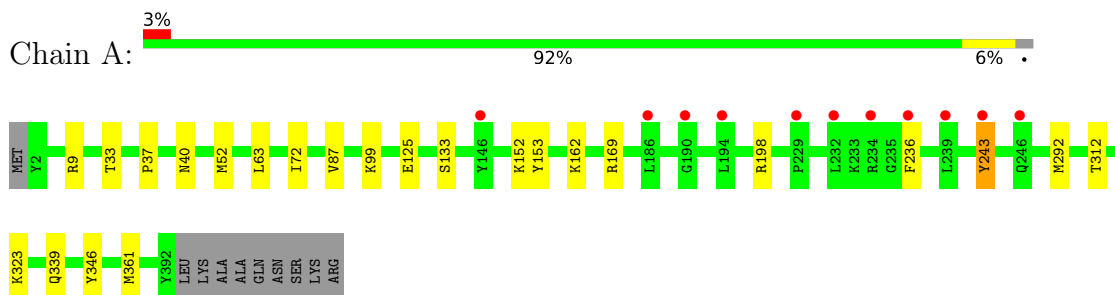

- Molecule 1: ACYL-COA DEHYDROGENASE

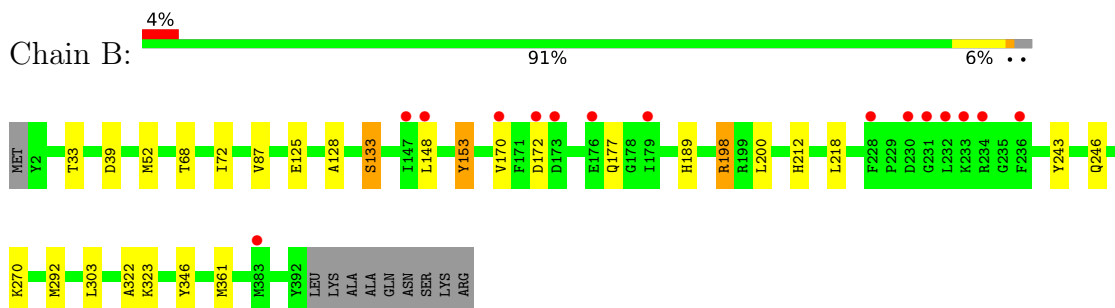

- Molecule 1: ACYL-COA DEHYDROGENASE

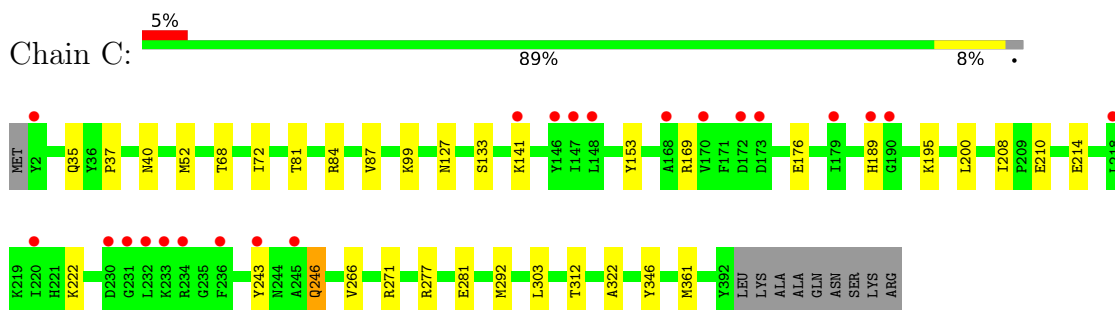

- Molecule 1: ACYL-COA DEHYDROGENASE

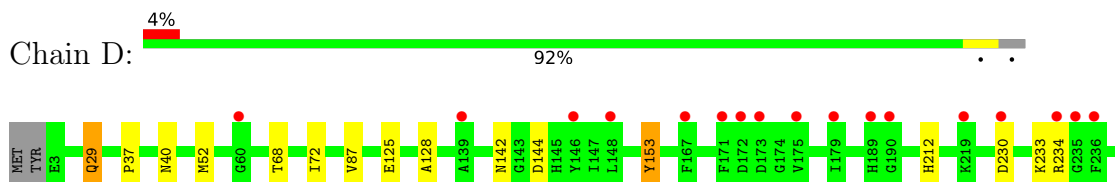



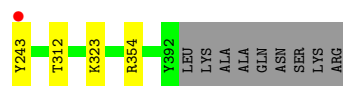

● Molecule 1: ACYL-COA DEHYDROGENASE

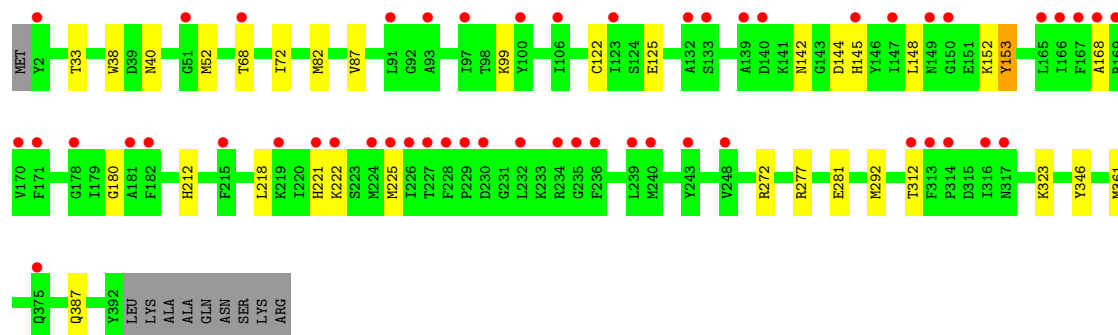
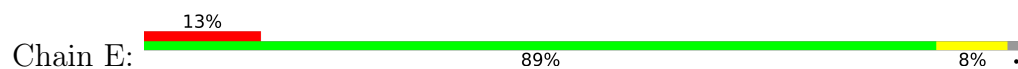

● Molecule 1: ACYL-COA DEHYDROGENASE

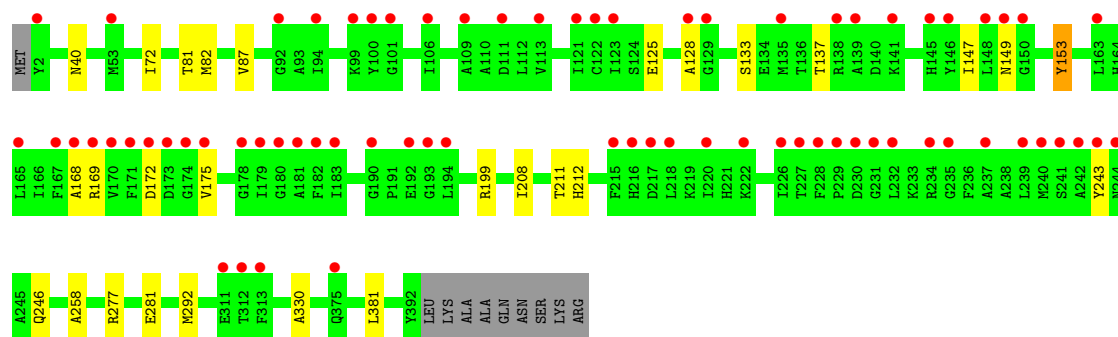
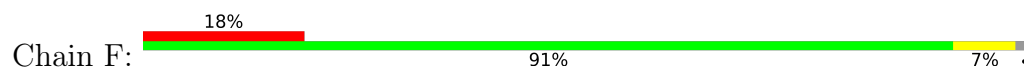

## 4 Data and refinement statistics

Property	Value	Source
Space group	P 21 21 2	Depositor
Cell constants a, b, c, $\alpha$ , $\beta$ , $\gamma$	100.07Å 233.49Å 121.28Å 90.00° 90.00° 90.00°	Depositor
Resolution (Å)	116.75 – 2.30 116.75 – 2.30	Depositor EDS
% Data completeness (in resolution range)	99.0 (116.75-2.30) 99.8 (116.75-2.30)	Depositor EDS
$R_{merge}$	0.08	Depositor
$R_{sym}$	(Not available)	Depositor
$\langle I/\sigma(I) \rangle$ <sup>1</sup>	2.49 (at 2.29Å)	Xtrriage
Refinement program	PHENIX (PHENIX.REFINE: 1.9_1692)	Depositor
R, $R_{free}$	0.200 , 0.244 0.201 , 0.246	Depositor DCC
$R_{free}$ test set	6352 reflections (5.02%)	wwPDB-VP
Wilson B-factor (Å <sup>2</sup> )	41.3	Xtrriage
Anisotropy	0.675	Xtrriage
Bulk solvent $k_{sol}$ (e/Å <sup>3</sup> ), $B_{sol}$ (Å <sup>2</sup> )	0.33 , 48.0	EDS
L-test for twinning <sup>2</sup>	$\langle  L  \rangle = 0.48$ , $\langle L^2 \rangle = 0.32$	Xtrriage
Estimated twinning fraction	No twinning to report.	Xtrriage
$F_o, F_c$ correlation	0.95	EDS
Total number of atoms	19886	wwPDB-VP
Average B, all atoms (Å <sup>2</sup> )	53.0	wwPDB-VP

Xtrriage's analysis on translational NCS is as follows: *The largest off-origin peak in the Patterson function is 10.29% of the height of the origin peak. No significant pseudotranslation is detected.*

<sup>1</sup>Intensities estimated from amplitudes.

<sup>2</sup>Theoretical values of  $\langle |L| \rangle$ ,  $\langle L^2 \rangle$  for acentric reflections are 0.5, 0.333 respectively for untwinned datasets, and 0.375, 0.2 for perfectly twinned datasets.

## 5 Model quality [i](#)

### 5.1 Standard geometry [i](#)

Bond lengths and bond angles in the following residue types are not validated in this section: SIN, COA, SO4, FAD

The Z score for a bond length (or angle) is the number of standard deviations the observed value is removed from the expected value. A bond length (or angle) with  $|Z| > 5$  is considered an outlier worth inspection. RMSZ is the root-mean-square of all Z scores of the bond lengths (or angles).

Mol	Chain	Bond lengths		Bond angles	
		RMSZ	# Z  >5	RMSZ	# Z  >5
1	A	0.21	0/3034	0.36	0/4095
1	B	0.21	0/3034	0.36	0/4095
1	C	0.21	0/3025	0.36	0/4083
1	D	0.21	0/3012	0.36	0/4065
1	E	0.21	0/3025	0.35	0/4083
1	F	0.21	0/3034	0.35	0/4095
All	All	0.21	0/18164	0.36	0/24516

There are no bond length outliers.

There are no bond angle outliers.

There are no chirality outliers.

There are no planarity outliers.

### 5.2 Too-close contacts [i](#)

In the following table, the Non-H and H(model) columns list the number of non-hydrogen atoms and hydrogen atoms in the chain respectively. The H(added) column lists the number of hydrogen atoms added and optimized by MolProbity. The Clashes column lists the number of clashes within the asymmetric unit, whereas Symm-Clashes lists symmetry-related clashes.

Mol	Chain	Non-H	H(model)	H(added)	Clashes	Symm-Clashes
1	A	2980	0	2971	18	0
1	B	2983	0	2970	19	0
1	C	2974	0	2963	22	0
1	D	2962	0	2954	13	0
1	E	2974	0	2963	24	0
1	F	2980	0	2971	14	0
2	A	53	0	31	1	0

*Continued on next page...*

Continued from previous page...

Mol	Chain	Non-H	H(model)	H(added)	Clashes	Symm-Clashes
2	B	53	0	31	1	0
2	C	53	0	31	0	0
2	D	53	0	31	2	0
2	E	53	0	31	1	0
2	F	53	0	31	3	0
3	A	48	0	32	2	0
3	B	48	0	32	1	0
3	D	48	0	32	3	0
3	E	48	0	32	1	0
3	F	48	0	32	2	0
4	C	8	0	4	3	0
5	C	5	0	0	0	0
6	A	327	0	0	6	0
6	B	271	0	0	4	0
6	C	236	0	0	6	0
6	D	220	0	0	4	0
6	E	203	0	0	7	0
6	F	205	0	0	1	0
All	All	19886	0	18142	109	0

The all-atom clashscore is defined as the number of clashes found per 1000 atoms (including hydrogen atoms). The all-atom clashscore for this structure is 3.

The worst 5 of 109 close contacts within the same asymmetric unit are listed below, sorted by their clash magnitude.

Atom-1	Atom-2	Interatomic distance (Å)	Clash overlap (Å)
1:E:122:CYS:SG	6:E:2084:HOH:O	2.44	0.75
1:B:243:TYR:OH	3:B:411:COA:S1P	2.48	0.69
1:E:180:GLY:O	6:E:2105:HOH:O	2.11	0.69
1:A:198:ARG:NH1	6:A:2172:HOH:O	2.29	0.66
1:D:354:ARG:NH1	6:D:2067:HOH:O	2.29	0.66

There are no symmetry-related clashes.

## 5.3 Torsion angles [i](#)

### 5.3.1 Protein backbone [i](#)

In the following table, the Percentiles column shows the percent Ramachandran outliers of the chain as a percentile score with respect to all X-ray entries followed by that with respect to entries of similar resolution.

The Analysed column shows the number of residues for which the backbone conformation was analysed, and the total number of residues.

Mol	Chain	Analysed	Favoured	Allowed	Outliers	Percentiles	
1	A	390/401 (97%)	382 (98%)	8 (2%)	0	100	100
1	B	390/401 (97%)	380 (97%)	10 (3%)	0	100	100
1	C	389/401 (97%)	381 (98%)	8 (2%)	0	100	100
1	D	388/401 (97%)	380 (98%)	8 (2%)	0	100	100
1	E	389/401 (97%)	381 (98%)	8 (2%)	0	100	100
1	F	390/401 (97%)	377 (97%)	13 (3%)	0	100	100
All	All	2336/2406 (97%)	2281 (98%)	55 (2%)	0	100	100

There are no Ramachandran outliers to report.

### 5.3.2 Protein sidechains [i](#)

In the following table, the Percentiles column shows the percent sidechain outliers of the chain as a percentile score with respect to all X-ray entries followed by that with respect to entries of similar resolution.

The Analysed column shows the number of residues for which the sidechain conformation was analysed, and the total number of residues.

Mol	Chain	Analysed	Rotameric	Outliers	Percentiles	
1	A	304/311 (98%)	302 (99%)	2 (1%)	84	92
1	B	304/311 (98%)	299 (98%)	5 (2%)	62	78
1	C	303/311 (97%)	298 (98%)	5 (2%)	60	76
1	D	302/311 (97%)	299 (99%)	3 (1%)	76	87
1	E	303/311 (97%)	301 (99%)	2 (1%)	84	92
1	F	304/311 (98%)	299 (98%)	5 (2%)	62	78
All	All	1820/1866 (98%)	1798 (99%)	22 (1%)	71	84

5 of 22 residues with a non-rotameric sidechain are listed below:

Mol	Chain	Res	Type
1	D	312	THR
1	F	147	ILE
1	E	225	MET
1	F	149	ASN
1	B	198	ARG

Sometimes sidechains can be flipped to improve hydrogen bonding and reduce clashes. 5 of 9 such sidechains are listed below:

Mol	Chain	Res	Type
1	F	177	GLN
1	F	212	HIS
1	D	295	GLN
1	D	355	HIS
1	D	370	GLN

### 5.3.3 RNA [i](#)

There are no RNA molecules in this entry.

### 5.4 Non-standard residues in protein, DNA, RNA chains [i](#)

There are no non-standard protein/DNA/RNA residues in this entry.

### 5.5 Carbohydrates [i](#)

There are no monosaccharides in this entry.

### 5.6 Ligand geometry [i](#)

13 ligands are modelled in this entry.

In the following table, the Counts columns list the number of bonds (or angles) for which Mogul statistics could be retrieved, the number of bonds (or angles) that are observed in the model and the number of bonds (or angles) that are defined in the Chemical Component Dictionary. The Link column lists molecule types, if any, to which the group is linked. The Z score for a bond length (or angle) is the number of standard deviations the observed value is removed from the expected value. A bond length (or angle) with  $|Z| > 2$  is considered an outlier worth inspection. RMSZ is the root-mean-square of all Z scores of the bond lengths (or angles).

Mol	Type	Chain	Res	Link	Bond lengths			Bond angles		
					Counts	RMSZ	$\# Z  > 2$	Counts	RMSZ	$\# Z  > 2$
3	COA	E	411	-	41,50,50	0.80	1 (2%)	52,75,75	1.15	5 (9%)
3	COA	F	411	-	41,50,50	0.80	1 (2%)	52,75,75	1.05	2 (3%)
5	SO4	C	1393	-	4,4,4	0.30	0	6,6,6	0.76	0
2	FAD	C	410	-	53,58,58	1.26	5 (9%)	68,89,89	1.29	10 (14%)
2	FAD	F	410	-	53,58,58	1.28	5 (9%)	68,89,89	1.32	11 (16%)
3	COA	B	411	-	41,50,50	0.80	1 (2%)	52,75,75	1.17	3 (5%)

Mol	Type	Chain	Res	Link	Bond lengths			Bond angles		
					Counts	RMSZ	# Z  > 2	Counts	RMSZ	# Z  > 2
4	SIN	C	412	-	7,7,7	0.99	0	8,8,8	1.56	2 (25%)
2	FAD	D	410	-	53,58,58	1.27	5 (9%)	68,89,89	1.29	9 (13%)
2	FAD	A	410	-	53,58,58	1.28	5 (9%)	68,89,89	1.28	9 (13%)
2	FAD	B	410	-	53,58,58	1.28	5 (9%)	68,89,89	1.27	9 (13%)
3	COA	A	411	-	41,50,50	0.81	1 (2%)	52,75,75	1.13	3 (5%)
3	COA	D	411	-	41,50,50	0.81	1 (2%)	52,75,75	1.17	4 (7%)
2	FAD	E	410	-	53,58,58	1.28	5 (9%)	68,89,89	1.30	10 (14%)

In the following table, the Chirals column lists the number of chiral outliers, the number of chiral centers analysed, the number of these observed in the model and the number defined in the Chemical Component Dictionary. Similar counts are reported in the Torsion and Rings columns. '-' means no outliers of that kind were identified.

Mol	Type	Chain	Res	Link	Chirals	Torsions	Rings
3	COA	E	411	-	-	10/44/64/64	0/3/3/3
3	COA	F	411	-	-	13/44/64/64	0/3/3/3
2	FAD	C	410	-	-	11/30/50/50	0/6/6/6
2	FAD	F	410	-	-	7/30/50/50	0/6/6/6
3	COA	B	411	-	-	10/44/64/64	0/3/3/3
4	SIN	C	412	-	-	0/5/5/5	-
2	FAD	D	410	-	-	11/30/50/50	0/6/6/6
2	FAD	A	410	-	-	10/30/50/50	0/6/6/6
2	FAD	B	410	-	-	8/30/50/50	0/6/6/6
3	COA	A	411	-	-	9/44/64/64	0/3/3/3
3	COA	D	411	-	-	5/44/64/64	0/3/3/3
2	FAD	E	410	-	-	8/30/50/50	0/6/6/6

The worst 5 of 35 bond length outliers are listed below:

Mol	Chain	Res	Type	Atoms	Z	Observed(Å)	Ideal(Å)
2	A	410	FAD	C9A-C5X	5.07	1.49	1.41
2	E	410	FAD	C9A-C5X	5.07	1.49	1.41
2	F	410	FAD	C9A-C5X	5.06	1.49	1.41
2	B	410	FAD	C9A-C5X	5.03	1.49	1.41
2	D	410	FAD	C9A-C5X	5.03	1.49	1.41

The worst 5 of 77 bond angle outliers are listed below:

Mol	Chain	Res	Type	Atoms	Z	Observed(°)	Ideal(°)
3	B	411	COA	P2A-O3A-P1A	-3.82	119.72	132.83
3	D	411	COA	P2A-O3A-P1A	-3.73	120.01	132.83
3	A	411	COA	P2A-O3A-P1A	-3.62	120.39	132.83
2	E	410	FAD	P-O3P-PA	-3.35	121.33	132.83
2	F	410	FAD	P-O3P-PA	-3.25	121.67	132.83

There are no chirality outliers.

5 of 102 torsion outliers are listed below:

Mol	Chain	Res	Type	Atoms
2	A	410	FAD	C5B-O5B-PA-O2A
2	A	410	FAD	C2'-C3'-C4'-O4'
2	A	410	FAD	O3'-C3'-C4'-O4'
2	A	410	FAD	O3'-C3'-C4'-C5'
2	B	410	FAD	C5B-O5B-PA-O2A

There are no ring outliers.

11 monomers are involved in 15 short contacts:

Mol	Chain	Res	Type	Clashes	Symm-Clashes
3	E	411	COA	1	0
3	F	411	COA	2	0
2	F	410	FAD	3	0
3	B	411	COA	1	0
4	C	412	SIN	3	0
2	D	410	FAD	2	0
2	A	410	FAD	1	0
2	B	410	FAD	1	0
3	A	411	COA	2	0
3	D	411	COA	3	0
2	E	410	FAD	1	0

The following is a two-dimensional graphical depiction of Mogul quality analysis of bond lengths, bond angles, torsion angles, and ring geometry for all instances of the Ligand of Interest. In addition, ligands with molecular weight > 250 and outliers as shown on the validation Tables will also be included. For torsion angles, if less than 5% of the Mogul distribution of torsion angles is within 10 degrees of the torsion angle in question, then that torsion angle is considered an outlier. Any bond that is central to one or more torsion angles identified as an outlier by Mogul will be highlighted in the graph. For rings, the root-mean-square deviation (RMSD) between the ring in question and similar rings identified by Mogul is calculated over all ring torsion angles. If the average RMSD is greater than 60 degrees and the minimal RMSD between the ring in question and any Mogul-identified rings is also greater than 60 degrees, then that ring is considered an outlier. The outliers are highlighted in purple. The color gray indicates Mogul did not find sufficient



equivalents in the CSD to analyse the geometry.

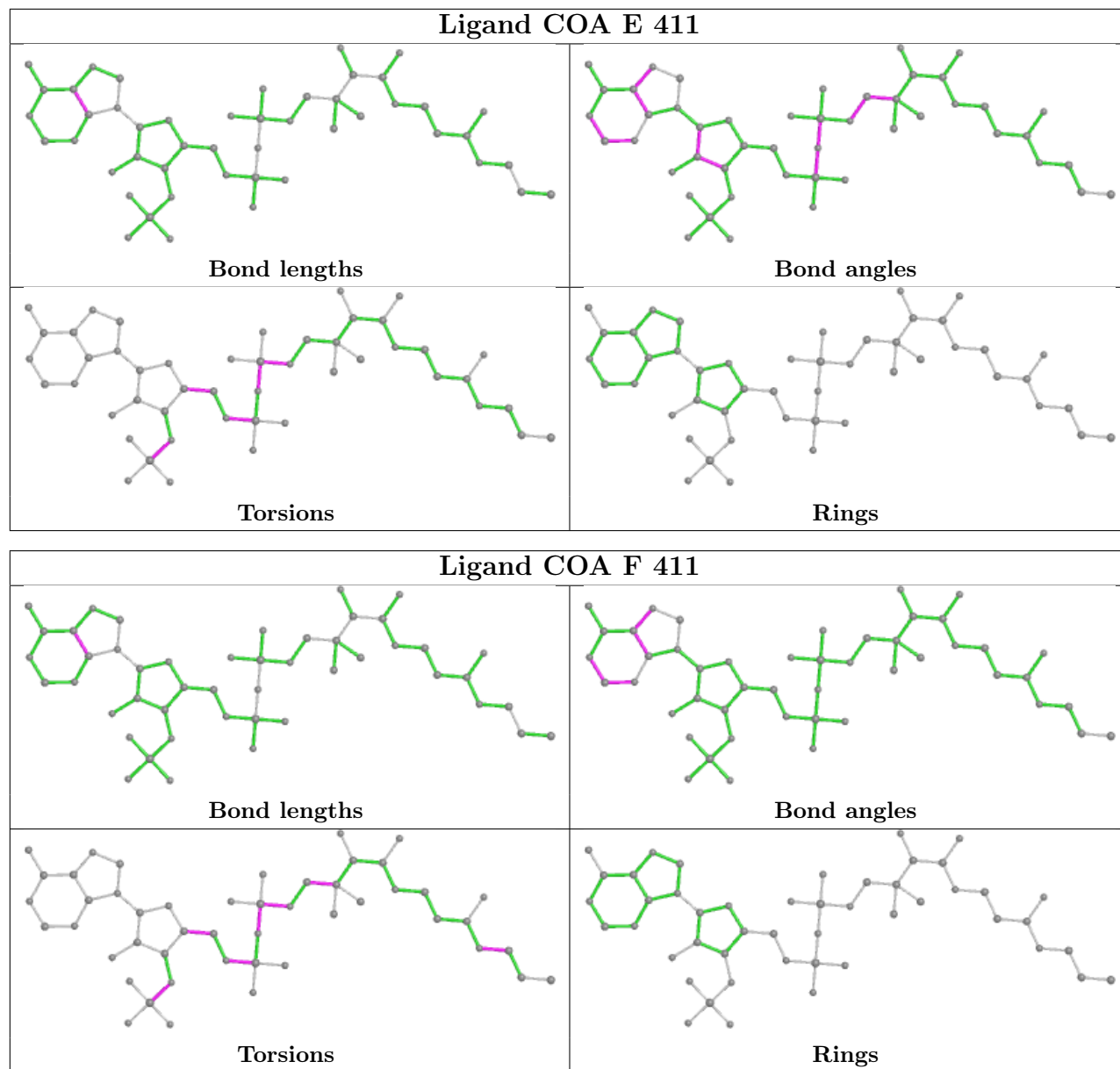

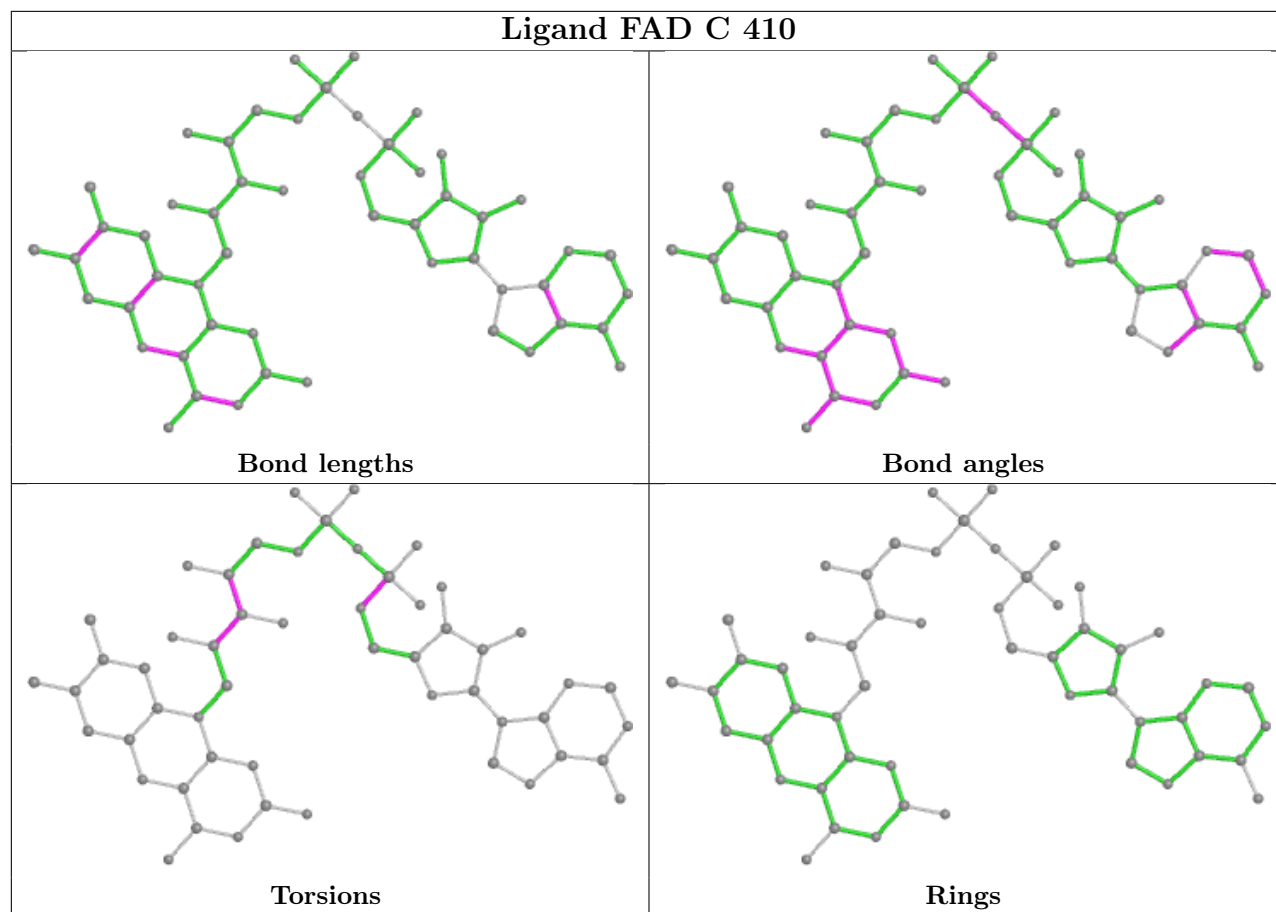

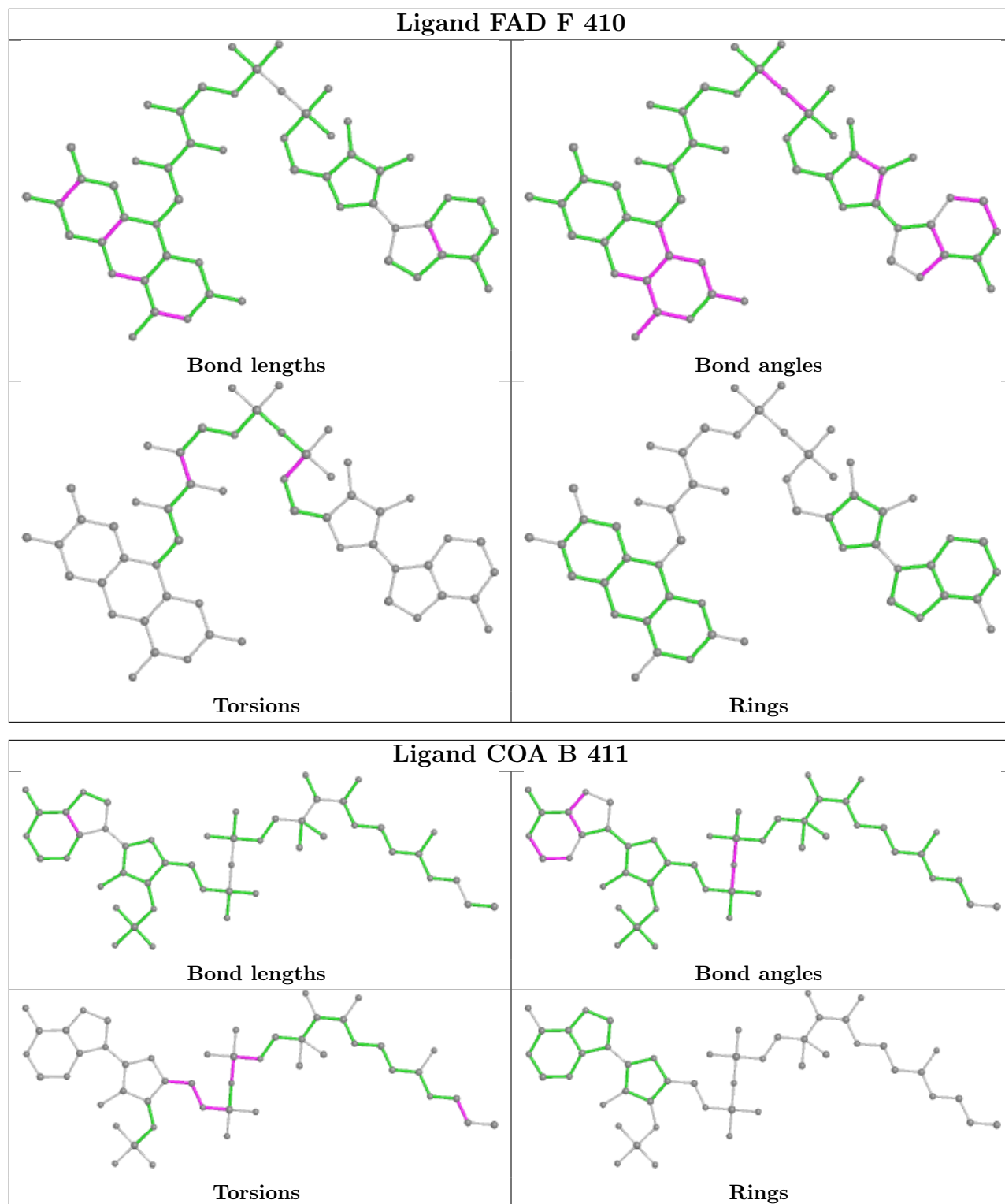

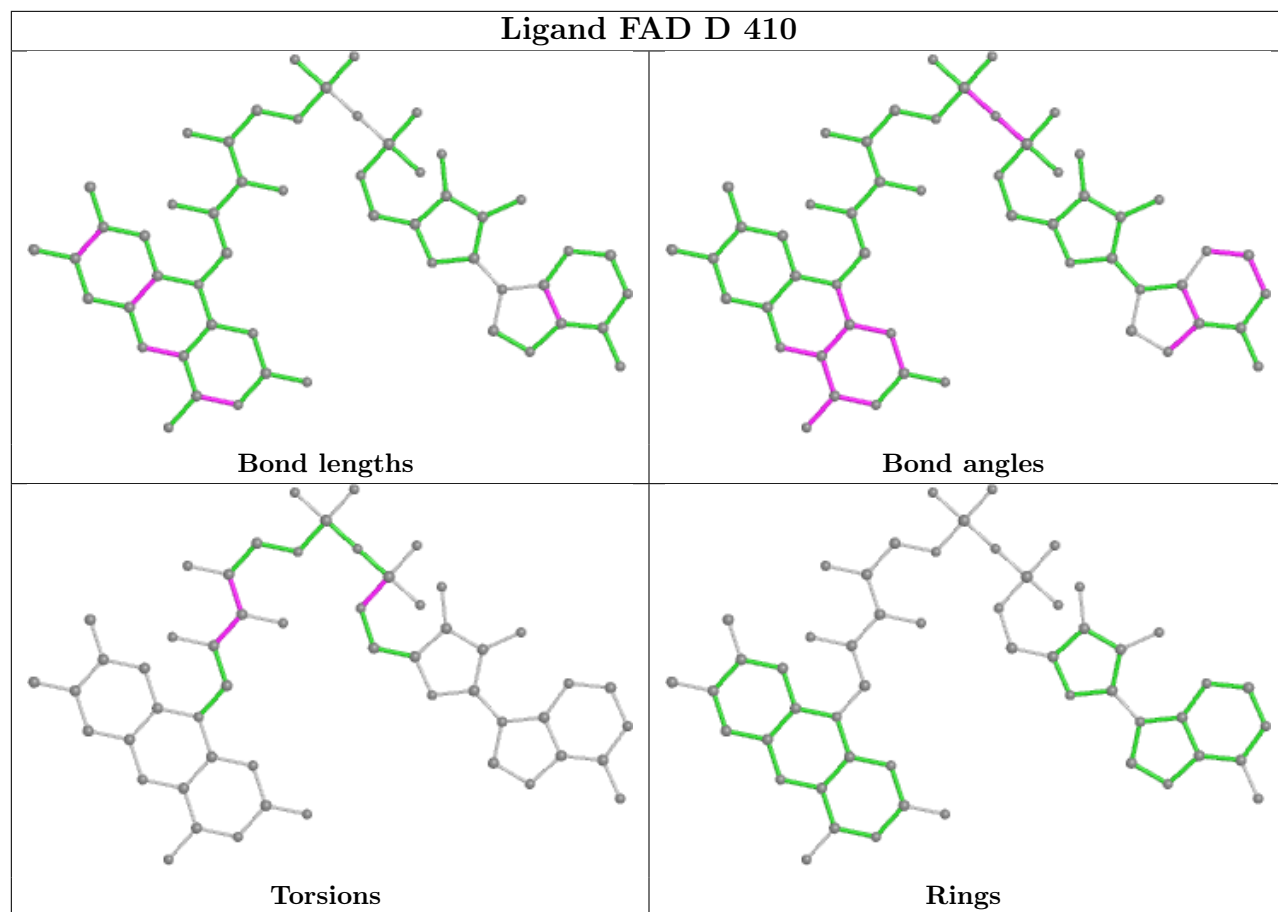

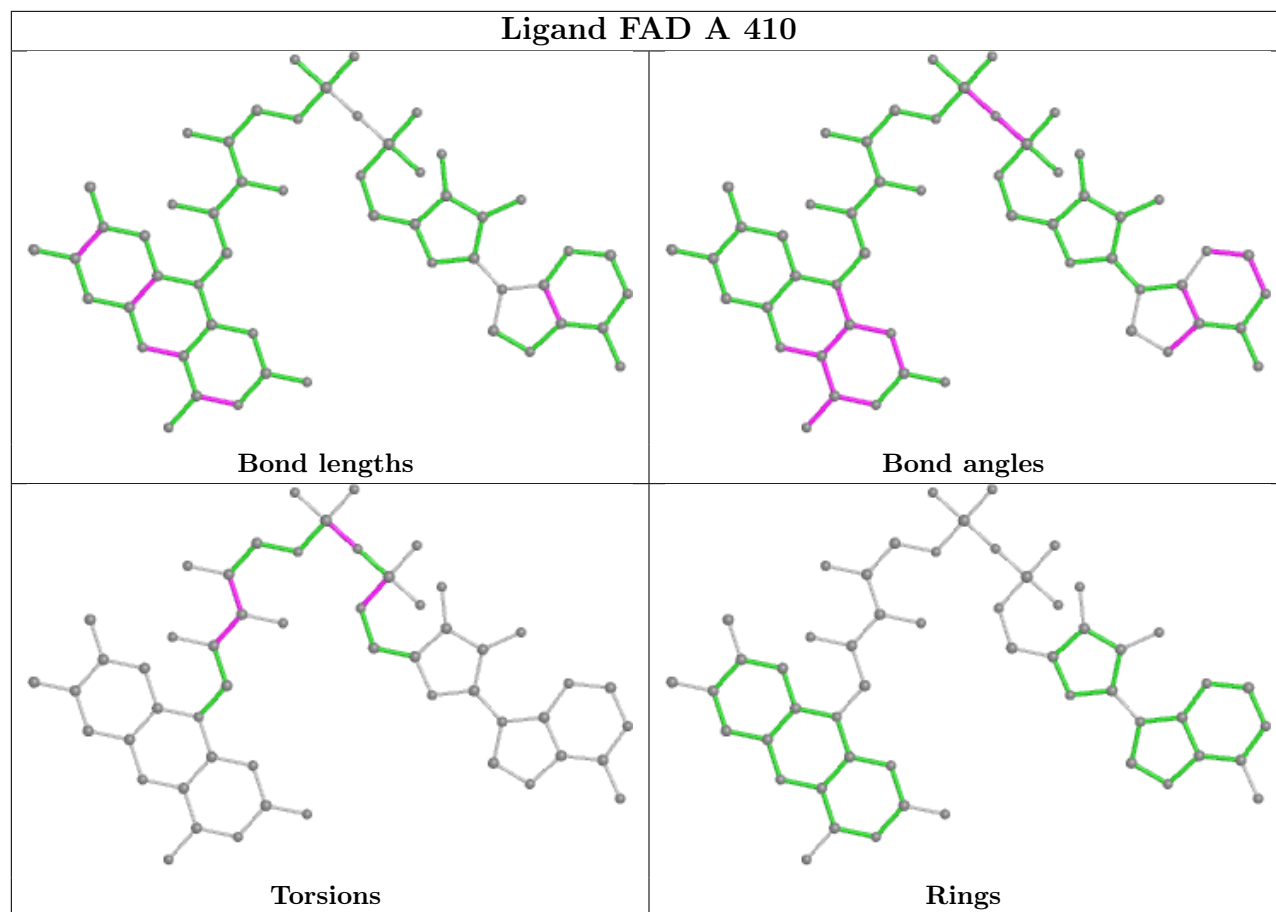

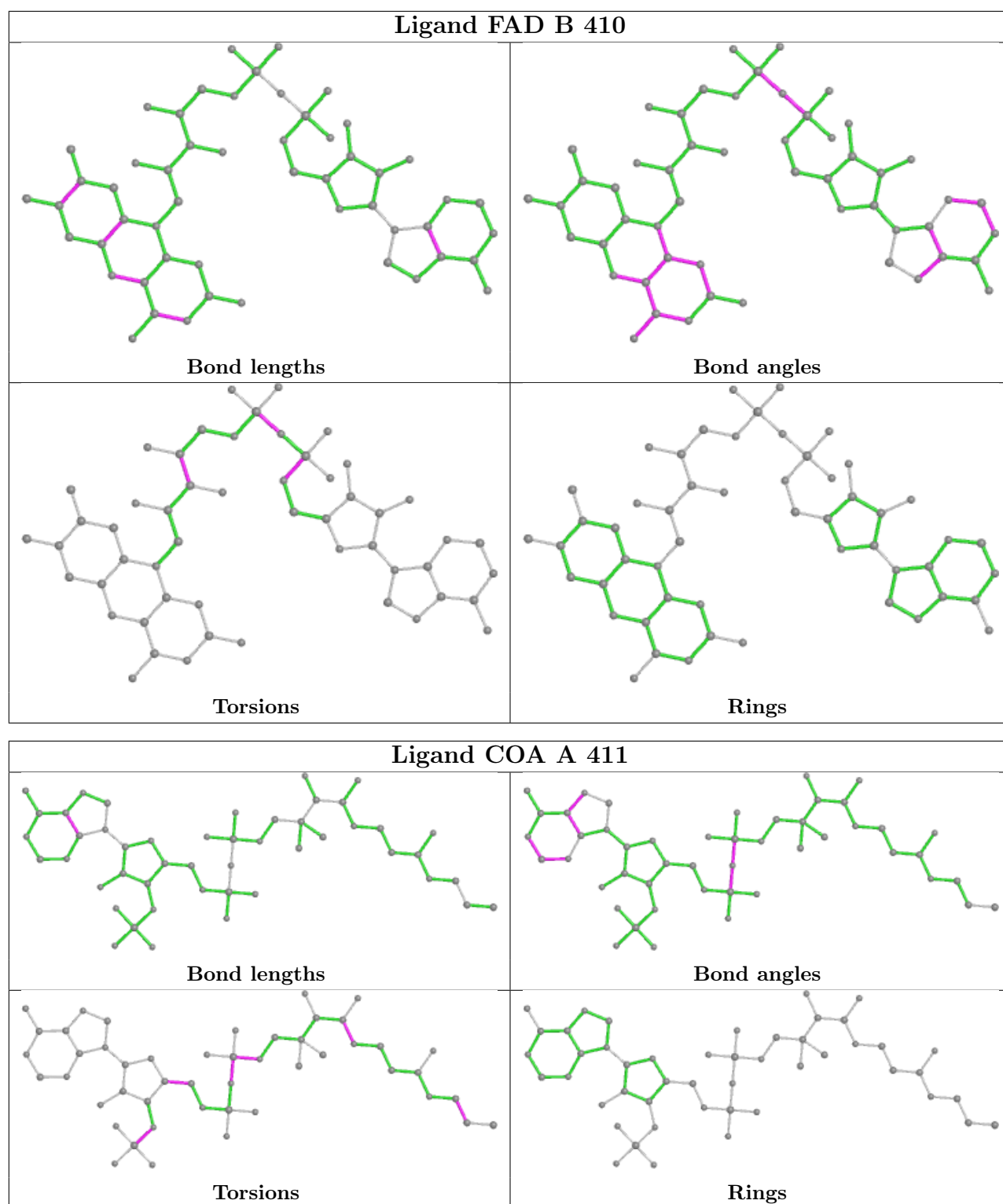

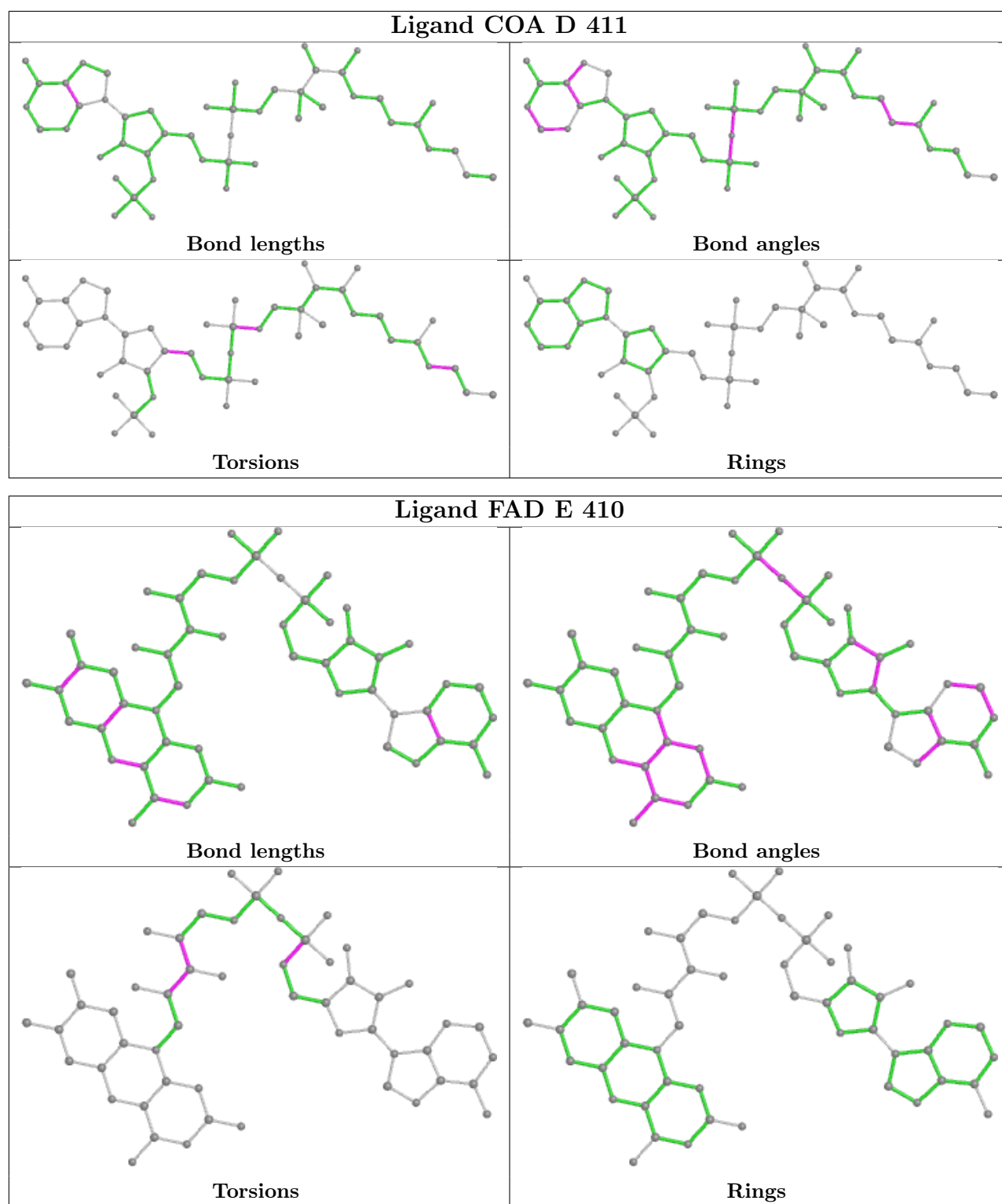

## 5.7 Other polymers [\(i\)](#)

There are no such residues in this entry.

## 5.8 Polymer linkage issues

There are no chain breaks in this entry.



## 6 Fit of model and data [i](#)

### 6.1 Protein, DNA and RNA chains [i](#)

In the following table, the column labelled ‘#RSRZ > 2’ contains the number (and percentage) of RSRZ outliers, followed by percent RSRZ outliers for the chain as percentile scores relative to all X-ray entries and entries of similar resolution. The OWAB column contains the minimum, median, 95<sup>th</sup> percentile and maximum values of the occupancy-weighted average B-factor per residue. The column labelled ‘Q < 0.9’ lists the number of (and percentage) of residues with an average occupancy less than 0.9.

Mol	Chain	Analysed	<RSRZ>	#RSRZ>2	OWAB(Å <sup>2</sup> )	Q<0.9
1	A	391/401 (97%)	0.15	11 (2%) 53 60	29, 43, 68, 98	0
1	B	391/401 (97%)	0.27	15 (3%) 40 47	27, 45, 84, 112	0
1	C	391/401 (97%)	0.35	22 (5%) 24 30	31, 50, 81, 104	0
1	D	390/401 (97%)	0.16	18 (4%) 32 39	34, 53, 77, 106	0
1	E	391/401 (97%)	0.74	52 (13%) 3 4	30, 53, 89, 112	0
1	F	391/401 (97%)	0.92	72 (18%) 1 1	30, 58, 101, 119	0
All	All	2345/2406 (97%)	0.43	190 (8%) 12 16	27, 50, 89, 119	0

The worst 5 of 190 RSRZ outliers are listed below:

Mol	Chain	Res	Type	RSRZ
1	F	171	PHE	8.8
1	F	170	VAL	7.5
1	C	236	PHE	7.0
1	E	226	ILE	6.8
1	F	100	TYR	6.8

### 6.2 Non-standard residues in protein, DNA, RNA chains [i](#)

There are no non-standard protein/DNA/RNA residues in this entry.

### 6.3 Carbohydrates [i](#)

There are no monosaccharides in this entry.

## 6.4 Ligands

In the following table, the Atoms column lists the number of modelled atoms in the group and the number defined in the chemical component dictionary. The B-factors column lists the minimum, median, 95<sup>th</sup> percentile and maximum values of B factors of atoms in the group. The column labelled 'Q< 0.9' lists the number of atoms with occupancy less than 0.9.

Mol	Type	Chain	Res	Atoms	RSCC	RSR	B-factors(Å <sup>2</sup> )	Q<0.9
3	COA	A	411	48/48	0.67	0.47	41,56,69,76	48
3	COA	E	411	48/48	0.75	0.40	58,66,75,91	48
3	COA	D	411	48/48	0.76	0.34	43,60,75,77	48
5	SO4	C	1393	5/5	0.79	0.28	83,88,102,163	0
3	COA	B	411	48/48	0.80	0.33	48,60,72,77	48
3	COA	F	411	48/48	0.83	0.26	61,71,79,115	48
4	SIN	C	412	8/8	0.91	0.36	39,60,75,98	0
2	FAD	E	410	53/53	0.94	0.16	35,53,64,68	0
2	FAD	F	410	53/53	0.95	0.14	50,61,77,84	0
2	FAD	B	410	53/53	0.96	0.14	29,42,52,57	0
2	FAD	A	410	53/53	0.97	0.16	26,33,47,51	0
2	FAD	C	410	53/53	0.97	0.15	28,39,52,64	0
2	FAD	D	410	53/53	0.97	0.15	31,40,54,62	0

The following is a graphical depiction of the model fit to experimental electron density of all instances of the Ligand of Interest. In addition, ligands with molecular weight > 250 and outliers as shown on the geometry validation Tables will also be included. Each fit is shown from different orientation to approximate a three-dimensional view.

**Electron density around COA A 411:**

$2mF_o-DF_c$  (at 0.7 rmsd) in gray  
 $mF_o-DF_c$  (at 3 rmsd) in purple (negative)  
and green (positive)

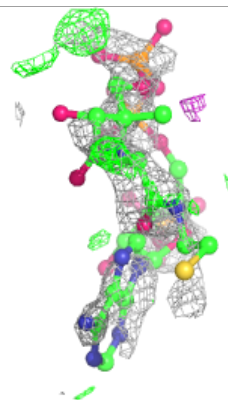
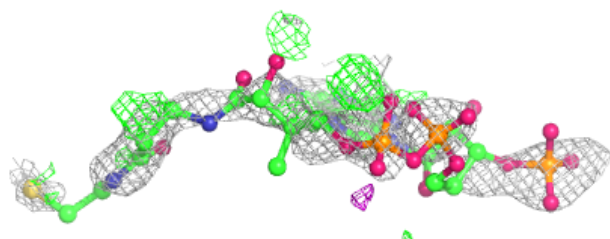
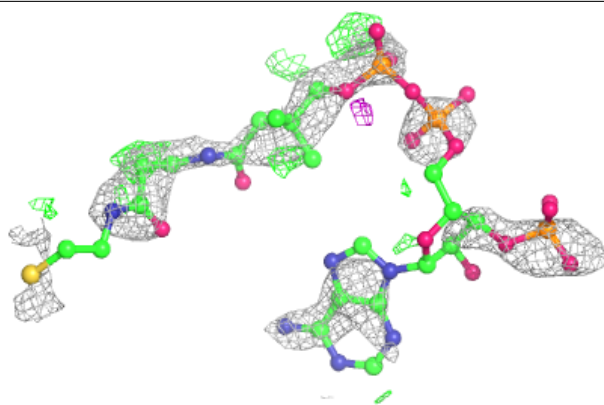
**Electron density around COA E 411:**

$2mF_o-DF_c$  (at 0.7 rmsd) in gray  
 $mF_o-DF_c$  (at 3 rmsd) in purple (negative)  
and green (positive)

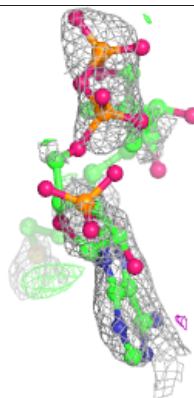
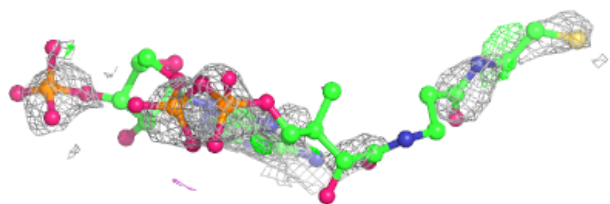
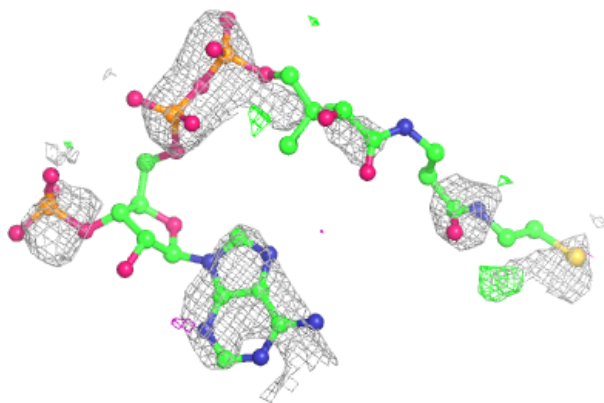

**Electron density around COA D 411:**

$2mF_o-DF_c$  (at 0.7 rmsd) in gray  
 $mF_o-DF_c$  (at 3 rmsd) in purple (negative)  
and green (positive)

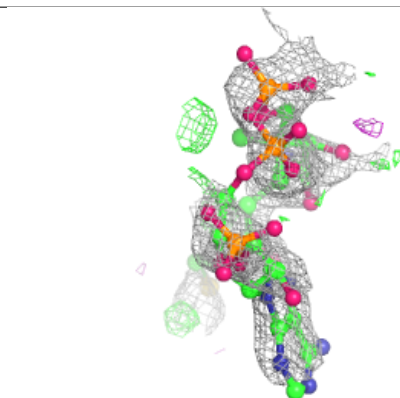
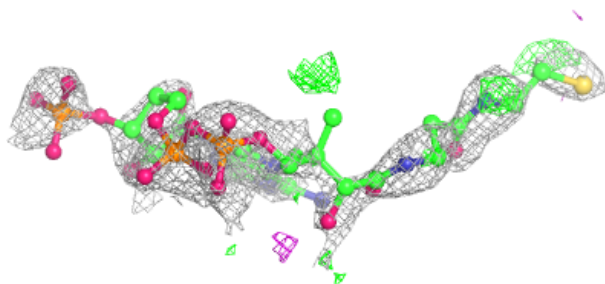
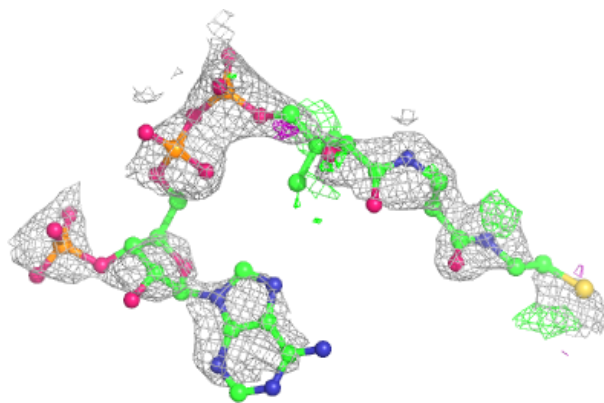
**Electron density around COA B 411:**

$2mF_o-DF_c$  (at 0.7 rmsd) in gray  
 $mF_o-DF_c$  (at 3 rmsd) in purple (negative)  
and green (positive)

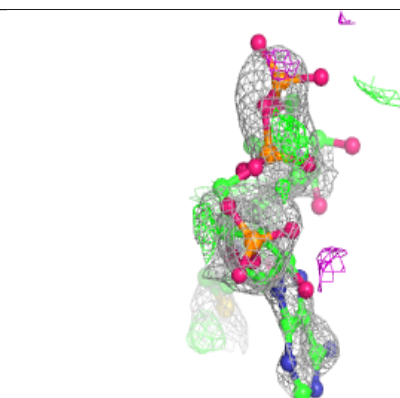
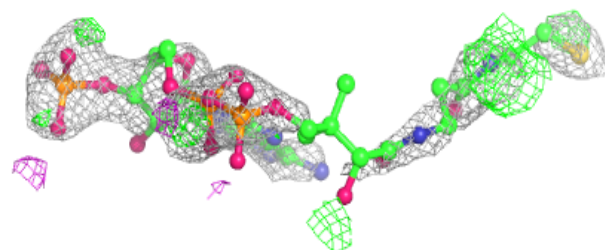
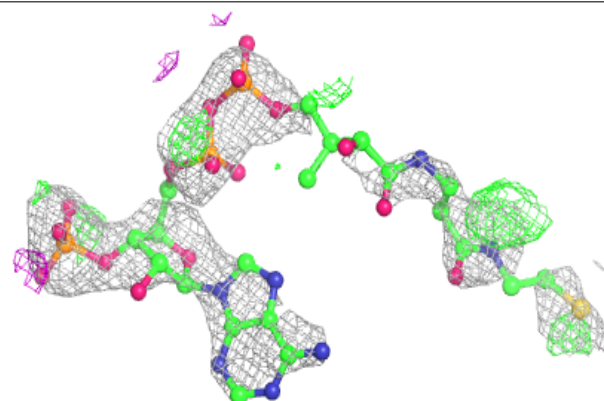

**Electron density around COA F 411:**

$2mF_o-DF_c$  (at 0.7 rmsd) in gray  
 $mF_o-DF_c$  (at 3 rmsd) in purple (negative)  
and green (positive)

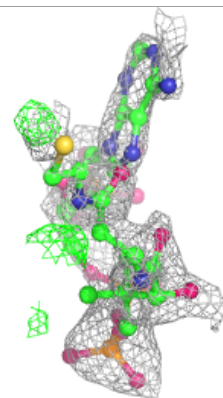
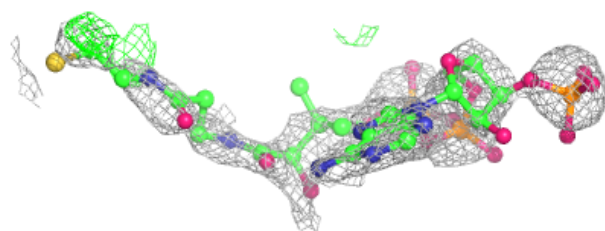
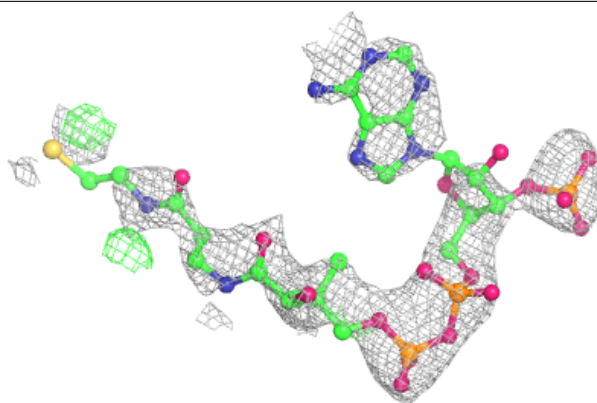
**Electron density around FAD E 410:**

$2mF_o-DF_c$  (at 0.7 rmsd) in gray  
 $mF_o-DF_c$  (at 3 rmsd) in purple (negative)  
and green (positive)

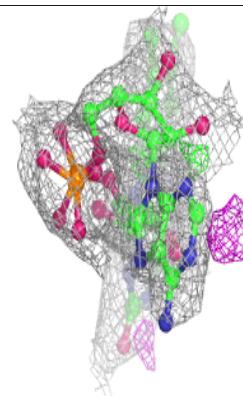
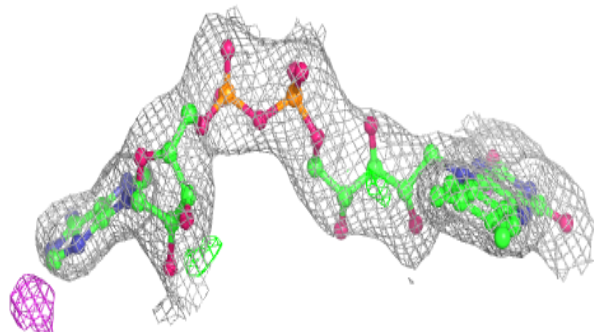
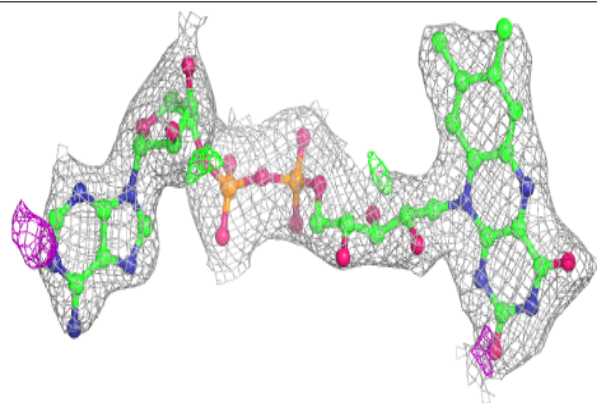



**Electron density around FAD F 410:**

$2mF_o-DF_c$  (at 0.7 rmsd) in gray  
 $mF_o-DF_c$  (at 3 rmsd) in purple (negative)  
and green (positive)

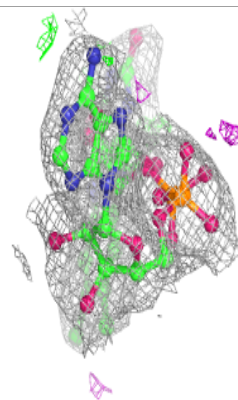
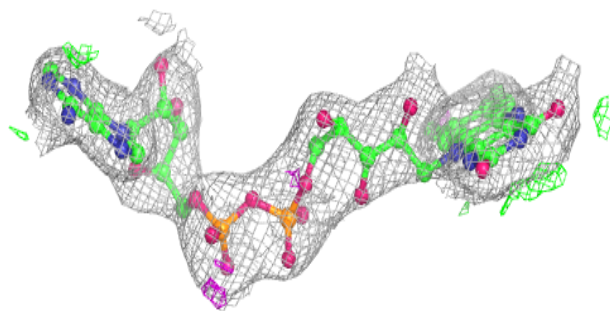
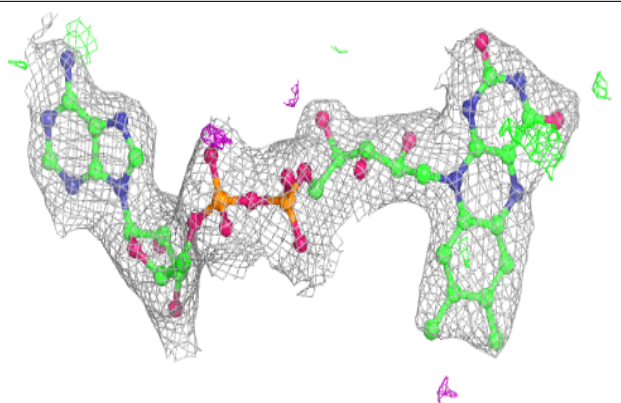
**Electron density around FAD B 410:**

$2mF_o-DF_c$  (at 0.7 rmsd) in gray  
 $mF_o-DF_c$  (at 3 rmsd) in purple (negative)  
and green (positive)

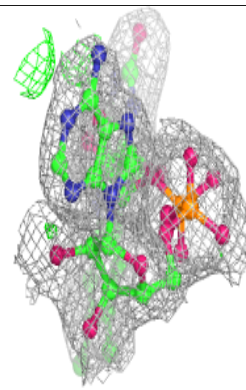
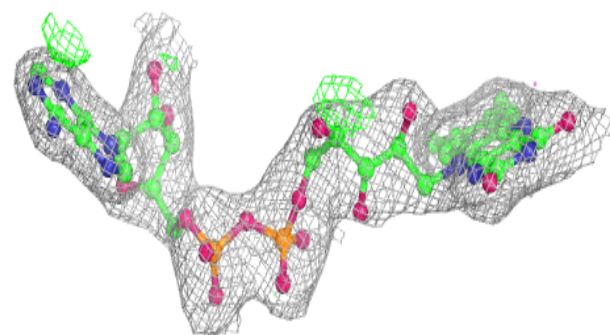
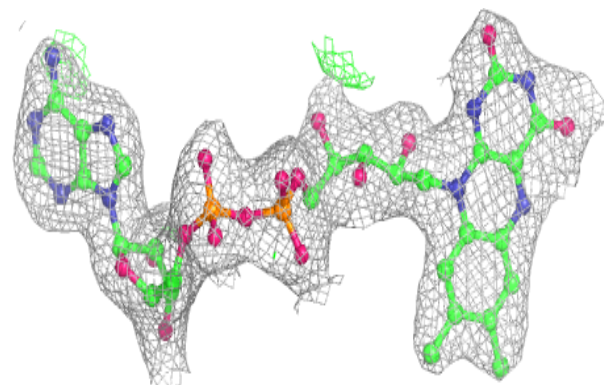

**Electron density around FAD A 410:**

$2mF_o-DF_c$  (at 0.7 rmsd) in gray  
 $mF_o-DF_c$  (at 3 rmsd) in purple (negative)  
and green (positive)

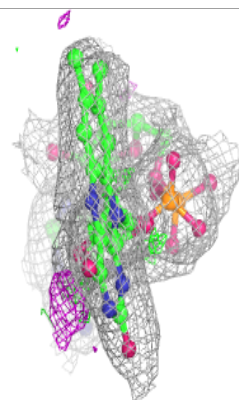
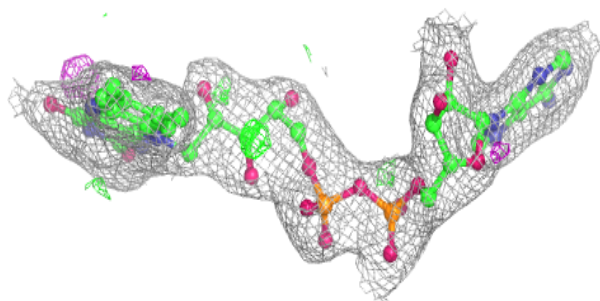
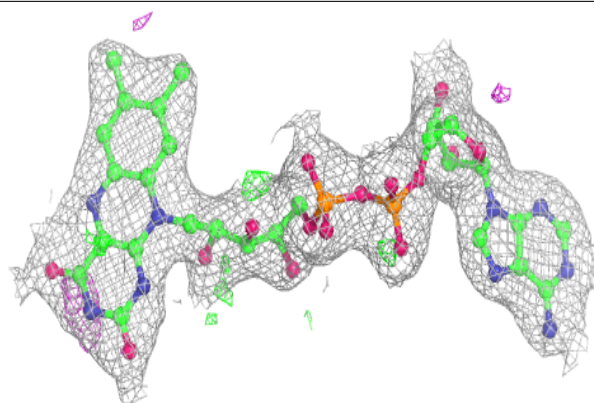
**Electron density around FAD C 410:**

$2mF_o-DF_c$  (at 0.7 rmsd) in gray  
 $mF_o-DF_c$  (at 3 rmsd) in purple (negative)  
and green (positive)

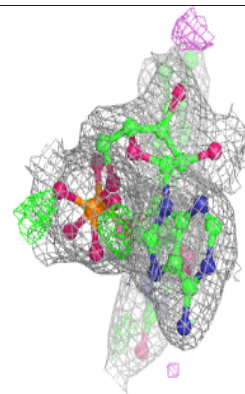
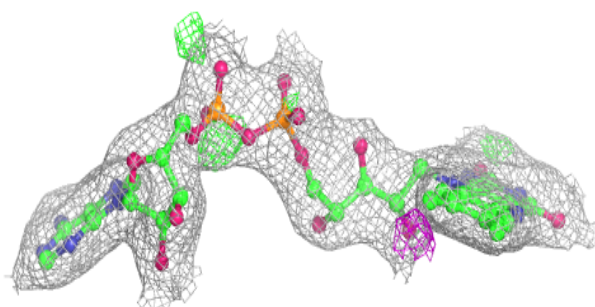
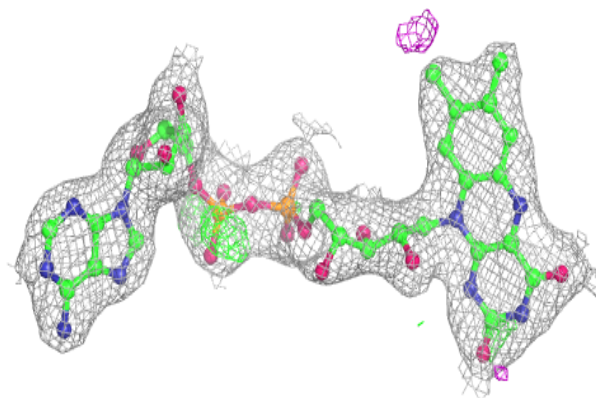

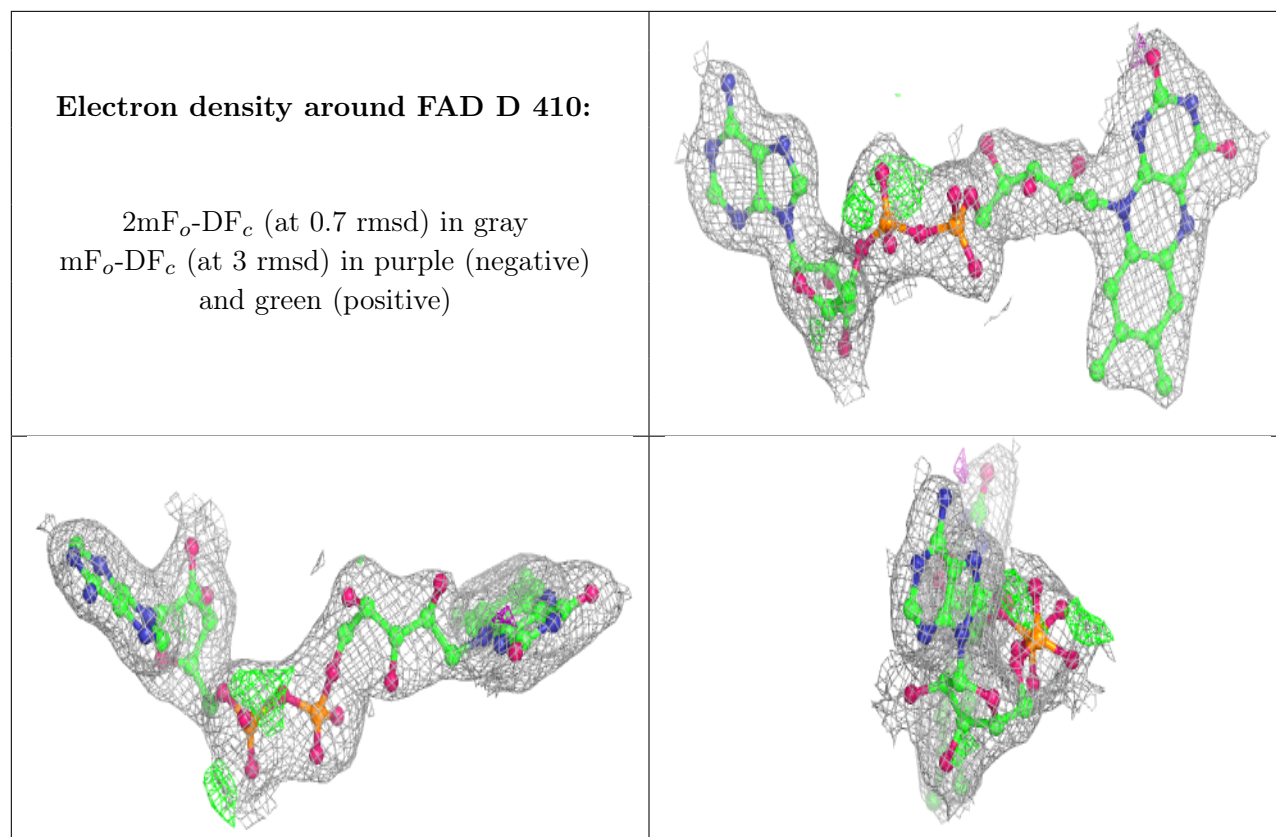

## 6.5 Other polymers [i](#)

There are no such residues in this entry.