



wwPDB EM Validation Summary Report ⓘ

Nov 6, 2022 – 12:08 PM EST

PDB ID : 6MYX
EMDB ID : EMD-9294
Title : Germline VRC01 antibody recognition of a modified clade C HIV-1 envelope trimer, 3 Fabs bound, sharpened map
Authors : Borst, A.J.; Weidle, C.E.; Gray, M.D.; Frenz, B.; Snijder, J.; Joyce, M.G.; Georgiev, I.S.; Stewart-Jones, G.B.E.; Kwong, P.D.; McGuire, A.T.; DiMaio, F.; Stamatatos, L.; Pancera, M.; Veesler, D.
Deposited on : 2018-11-02
Resolution : 3.80 Å(reported)

This is a wwPDB EM Validation Summary Report for a publicly released PDB entry.

We welcome your comments at validation@mail.wwpdb.org

A user guide is available at

<https://www.wwpdb.org/validation/2017/EMValidationReportHelp>

with specific help available everywhere you see the ⓘ symbol.

The types of validation reports are described at

<http://www.wwpdb.org/validation/2017/FAQs#types>.

The following versions of software and data (see [references ⓘ](#)) were used in the production of this report:

EMDB validation analysis : 0.0.1.dev43
Mogul : 1.8.5 (274361), CSD as541be (2020)
MolProbity : 4.02b-467
Percentile statistics : 20191225.v01 (using entries in the PDB archive December 25th 2019)
MapQ : 1.9.9
Ideal geometry (proteins) : Engh & Huber (2001)
Ideal geometry (DNA, RNA) : Parkinson et al. (1996)
Validation Pipeline (wwPDB-VP) : 2.31.2

1 Overall quality at a glance

The following experimental techniques were used to determine the structure:

ELECTRON MICROSCOPY

The reported resolution of this entry is 3.80 Å.

Percentile scores (ranging between 0-100) for global validation metrics of the entry are shown in the following graphic. The table shows the number of entries on which the scores are based.

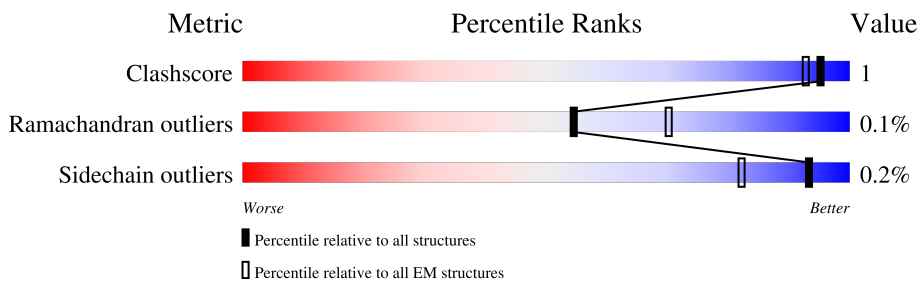









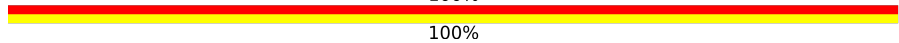
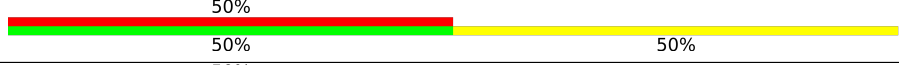
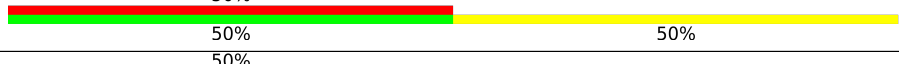
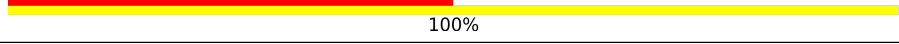
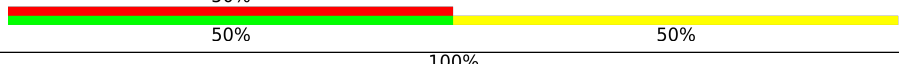
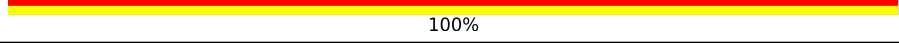
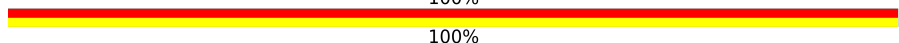

Metric	Whole archive (#Entries)	EM structures (#Entries)
Clashscore	158937	4297
Ramachandran outliers	154571	4023
Sidechain outliers	154315	3826

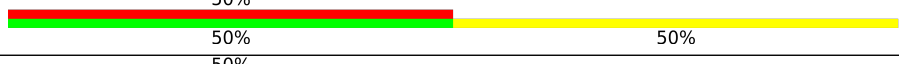
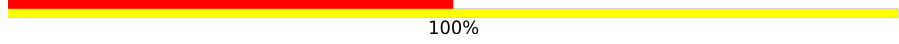
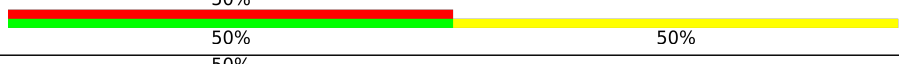
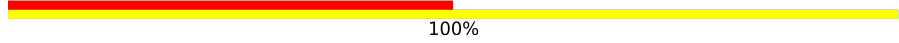
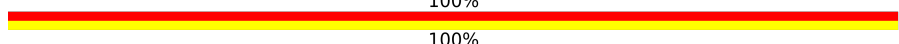
The table below summarises the geometric issues observed across the polymeric chains and their fit to the map. The red, orange, yellow and green segments of the bar indicate the fraction of residues that contain outliers for ≥ 3 , 2, 1 and 0 types of geometric quality criteria respectively. A grey segment represents the fraction of residues that are not modelled. The numeric value for each fraction is indicated below the corresponding segment, with a dot representing fractions $\leq 5\%$. The upper red bar (where present) indicates the fraction of residues that have poor fit to the EM map (all-atom inclusion $< 40\%$). The numeric value is given above the bar.

Mol	Chain	Length	Quality of chain
1	A	626	
1	B	626	
1	E	626	
2	C	229	
2	F	229	
2	L	229	
3	D	233	
3	G	233	

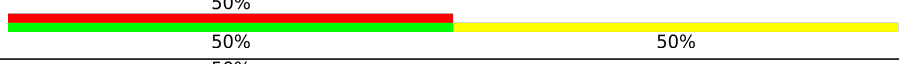
Continued on next page...

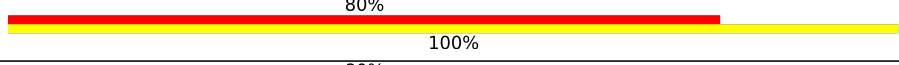
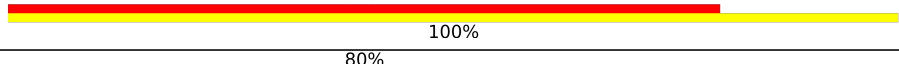
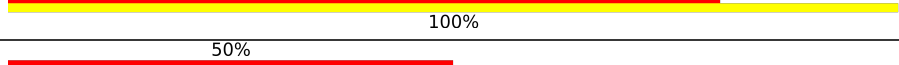
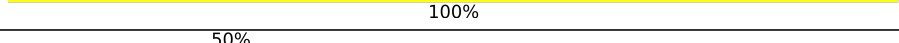
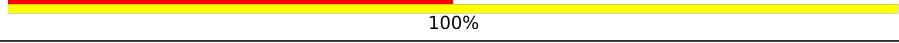
Continued from previous page...

Mol	Chain	Length	Quality of chain
3	H	233	 48% 49% 100%
4	I	2	 100% 100%
4	J	2	 50% 50% 50%
4	S	2	 50% 50% 50%
4	U	2	 50% 100%
4	V	2	 50% 50% 50%
4	W	2	 100% 100%
4	X	2	 100% 100%
4	Y	2	 50% 50% 50%
4	g	2	 50% 50% 50%
4	i	2	 50% 100%
4	j	2	 50% 50% 50%
4	k	2	 50% 100%
4	l	2	 100% 100%
4	m	2	 50% 50% 50%
4	u	2	 50% 50% 50%
4	w	2	 50% 100%
4	x	2	 50% 50% 50%
4	y	2	 50% 100%
5	K	5	 80% 100%
5	Z	5	 80% 100%
5	n	5	 80% 100%
6	M	6	 50% 100%
6	a	6	 50% 100%
6	o	6	 50% 100%

Continued on next page...

Continued from previous page...

Mol	Chain	Length	Quality of chain
7	N	3	33% 33% 67%
7	P	3	67% 33% 67%
7	Q	3	67% 100%
7	b	3	67% 33% 67%
7	d	3	67% 33% 67%
7	e	3	67% 100%
7	p	3	33% 33% 67%
7	r	3	67% 33% 67%
7	s	3	67% 100%
8	O	7	43% 100%
8	c	7	43% 100%
8	q	7	43% 100%
9	R	4	50% 100%
9	f	4	50% 100%
9	t	4	50% 100%
10	T	5	60% 100%
10	h	5	60% 100%
10	v	5	60% 100%

2 Entry composition [i](#)

There are 11 unique types of molecules in this entry. The entry contains 20139 atoms, of which 0 are hydrogens and 0 are deuteriums.

In the tables below, the AltConf column contains the number of residues with at least one atom in alternate conformation and the Trace column contains the number of residues modelled with at most 2 atoms.

- Molecule 1 is a protein called 426c DS-SOSIP D3.

Mol	Chain	Residues	Atoms					AltConf	Trace
			Total	C	N	O	S		
1	A	550	4338	2736	757	811	34	0	0
1	B	550	4338	2736	757	811	34	0	0
1	E	550	4338	2736	757	811	34	0	0

- Molecule 2 is a protein called VRC01GL light chain.

Mol	Chain	Residues	Atoms					AltConf	Trace
			Total	C	N	O	S		
2	L	100	767	485	127	153	2	0	0
2	C	100	767	485	127	153	2	0	0
2	F	100	767	485	127	153	2	0	0

- Molecule 3 is a protein called VRC01GL heavy chain.

Mol	Chain	Residues	Atoms					AltConf	Trace
			Total	C	N	O	S		
3	H	119	940	591	165	177	7	0	0
3	D	119	940	591	165	177	7	0	0
3	G	119	940	591	165	177	7	0	0

There are 18 discrepancies between the modelled and reference sequences:

Chain	Residue	Modelled	Actual	Comment	Reference
H	220	HIS	-	expression tag	UNP S6C4S0
H	221	HIS	-	expression tag	UNP S6C4S0
H	222	HIS	-	expression tag	UNP S6C4S0

Continued on next page...

Continued from previous page...

Chain	Residue	Modelled	Actual	Comment	Reference
H	223	HIS	-	expression tag	UNP S6C4S0
H	224	HIS	-	expression tag	UNP S6C4S0
H	225	HIS	-	expression tag	UNP S6C4S0
D	220	HIS	-	expression tag	UNP S6C4S0
D	221	HIS	-	expression tag	UNP S6C4S0
D	222	HIS	-	expression tag	UNP S6C4S0
D	223	HIS	-	expression tag	UNP S6C4S0
D	224	HIS	-	expression tag	UNP S6C4S0
D	225	HIS	-	expression tag	UNP S6C4S0
G	220	HIS	-	expression tag	UNP S6C4S0
G	221	HIS	-	expression tag	UNP S6C4S0
G	222	HIS	-	expression tag	UNP S6C4S0
G	223	HIS	-	expression tag	UNP S6C4S0
G	224	HIS	-	expression tag	UNP S6C4S0
G	225	HIS	-	expression tag	UNP S6C4S0

- Molecule 4 is an oligosaccharide called 2-acetamido-2-deoxy-beta-D-glucopyranose-(1-4)-2-acetamido-2-deoxy-beta-D-glucopyranose.



Mol	Chain	Residues	Atoms				AltConf	Trace
			Total	C	N	O		
4	I	2	28	16	2	10	0	0
4	J	2	28	16	2	10	0	0
4	S	2	28	16	2	10	0	0
4	U	2	28	16	2	10	0	0
4	V	2	28	16	2	10	0	0
4	W	2	28	16	2	10	0	0
4	X	2	28	16	2	10	0	0
4	Y	2	28	16	2	10	0	0
4	g	2	28	16	2	10	0	0

Continued on next page...

Continued from previous page...

Mol	Chain	Residues	Atoms				AltConf	Trace
			Total	C	N	O		
4	i	2	Total 28	C 16	N 2	O 10	0	0
4	j	2	Total 28	C 16	N 2	O 10	0	0
4	k	2	Total 28	C 16	N 2	O 10	0	0
4	l	2	Total 28	C 16	N 2	O 10	0	0
4	m	2	Total 28	C 16	N 2	O 10	0	0
4	u	2	Total 28	C 16	N 2	O 10	0	0
4	w	2	Total 28	C 16	N 2	O 10	0	0
4	x	2	Total 28	C 16	N 2	O 10	0	0
4	y	2	Total 28	C 16	N 2	O 10	0	0

- Molecule 5 is an oligosaccharide called alpha-D-mannopyranose-(1-3)-[alpha-D-mannopyranose-(1-6)]beta-D-mannopyranose-(1-4)-2-acetamido-2-deoxy-beta-D-glucopyranose-(1-4)-2-acetamido-2-deoxy-beta-D-glucopyranose.

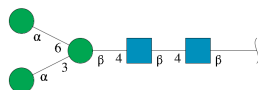

Mol	Chain	Residues	Atoms				AltConf	Trace
			Total	C	N	O		
5	K	5	Total 61	C 34	N 2	O 25	0	0
5	Z	5	Total 61	C 34	N 2	O 25	0	0
5	n	5	Total 61	C 34	N 2	O 25	0	0

- Molecule 6 is an oligosaccharide called alpha-D-mannopyranose-(1-3)-alpha-D-mannopyranose-(1-6)-[alpha-D-mannopyranose-(1-3)]beta-D-mannopyranose-(1-4)-2-acetamido-2-deoxy-beta-D-glucopyranose-(1-4)-2-acetamido-2-deoxy-beta-D-glucopyranose.

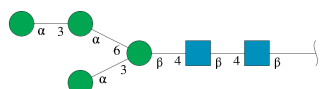

Mol	Chain	Residues	Atoms				AltConf	Trace
			Total	C	N	O		
6	M	6	72	40	2	30	0	0
6	a	6	72	40	2	30	0	0
6	o	6	72	40	2	30	0	0

- Molecule 7 is an oligosaccharide called beta-D-mannopyranose-(1-4)-2-acetamido-2-deoxy-beta-D-glucopyranose-(1-4)-2-acetamido-2-deoxy-beta-D-glucopyranose.

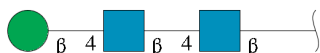

Mol	Chain	Residues	Atoms				AltConf	Trace
			Total	C	N	O		
7	N	3	39	22	2	15	0	0
7	P	3	39	22	2	15	0	0
7	Q	3	39	22	2	15	0	0
7	b	3	39	22	2	15	0	0
7	d	3	39	22	2	15	0	0
7	e	3	39	22	2	15	0	0
7	p	3	39	22	2	15	0	0
7	r	3	39	22	2	15	0	0
7	s	3	39	22	2	15	0	0

- Molecule 8 is an oligosaccharide called alpha-D-mannopyranose-(1-2)-alpha-D-mannopyranose-(1-3)-[alpha-D-mannopyranose-(1-3)-alpha-D-mannopyranose-(1-6)]beta-D-mannopyranose-(1-4)-2-acetamido-2-deoxy-beta-D-glucopyranose-(1-4)-2-acetamido-2-deoxy-beta-D-glucopyranose.

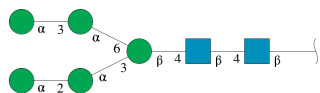

Mol	Chain	Residues	Atoms				AltConf	Trace
8	O	7	Total	C	N	O	0	0
			83	46	2	35		
8	c	7	Total	C	N	O	0	0
			83	46	2	35		
8	q	7	Total	C	N	O	0	0
			83	46	2	35		

- Molecule 9 is an oligosaccharide called alpha-D-mannopyranose-(1-3)-beta-D-mannopyranose-(1-4)-2-acetamido-2-deoxy-beta-D-glucopyranose-(1-4)-2-acetamido-2-deoxy-beta-D-glucopyranose.



Mol	Chain	Residues	Atoms				AltConf	Trace
9	R	4	Total	C	N	O	0	0
			50	28	2	20		
9	f	4	Total	C	N	O	0	0
			50	28	2	20		
9	t	4	Total	C	N	O	0	0
			50	28	2	20		

- Molecule 10 is an oligosaccharide called alpha-D-mannopyranose-(1-2)-alpha-D-mannopyranose-(1-3)-beta-D-mannopyranose-(1-4)-2-acetamido-2-deoxy-beta-D-glucopyranose-(1-4)-2-acetamido-2-deoxy-beta-D-glucopyranose.

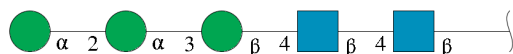

Mol	Chain	Residues	Atoms				AltConf	Trace
10	T	5	Total	C	N	O	0	0
			61	34	2	25		
10	h	5	Total	C	N	O	0	0
			61	34	2	25		
10	v	5	Total	C	N	O	0	0
			61	34	2	25		

- Molecule 11 is 2-acetamido-2-deoxy-beta-D-glucopyranose (three-letter code: NAG) (formula: C₈H₁₅NO₆).

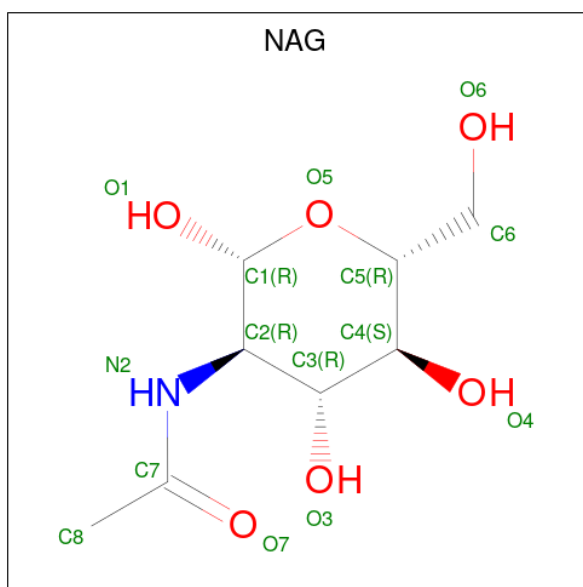

Mol	Chain	Residues	Atoms				AltConf
			Total	C	N	O	
11	A	1	Total 56	C 32	N 4	O 20	0
11	A	1	Total 56	C 32	N 4	O 20	0
11	A	1	Total 56	C 32	N 4	O 20	0
11	A	1	Total 56	C 32	N 4	O 20	0
11	B	1	Total 56	C 32	N 4	O 20	0
11	B	1	Total 56	C 32	N 4	O 20	0
11	B	1	Total 56	C 32	N 4	O 20	0
11	B	1	Total 56	C 32	N 4	O 20	0
11	E	1	Total 56	C 32	N 4	O 20	0
11	E	1	Total 56	C 32	N 4	O 20	0
11	E	1	Total 56	C 32	N 4	O 20	0
11	E	1	Total 56	C 32	N 4	O 20	0

3 Residue-property plots

These plots are drawn for all protein, RNA, DNA and oligosaccharide chains in the entry. The first graphic for a chain summarises the proportions of the various outlier classes displayed in the second graphic. The second graphic shows the sequence view annotated by issues in geometry and atom inclusion in map density. Residues are color-coded according to the number of geometric quality criteria for which they contain at least one outlier: green = 0, yellow = 1, orange = 2 and red = 3 or more. A red diamond above a residue indicates a poor fit to the EM map for this residue (all-atom inclusion < 40%). Stretches of 2 or more consecutive residues without any outlier are shown as a green connector. Residues present in the sample, but not in the model, are shown in grey.

- Molecule 1: 426c DS-SOSIP D3

Chain A: 

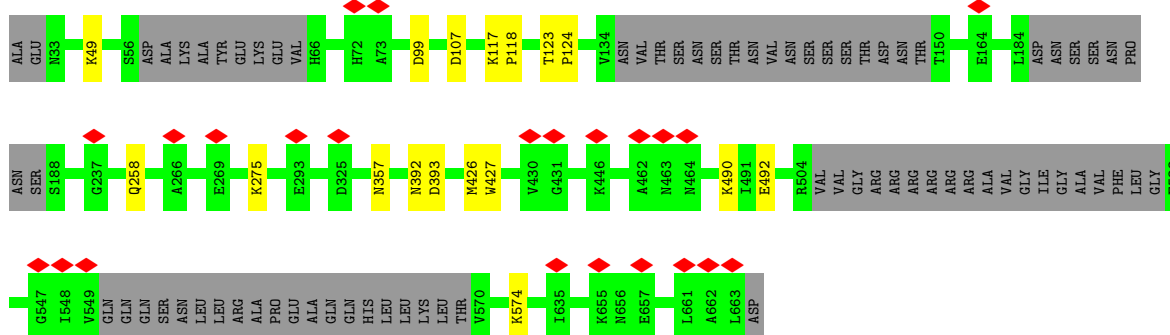

- Molecule 1: 426c DS-SOSIP D3

Chain B: 

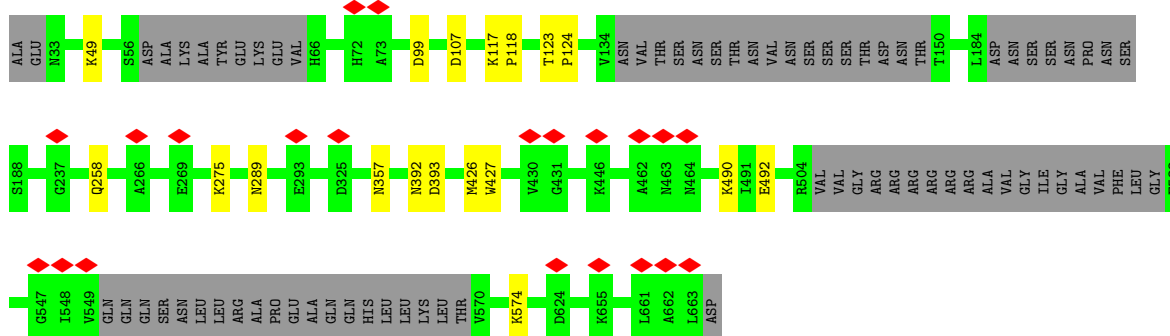

- Molecule 1: 426c DS-SOSIP D3

Chain E: 

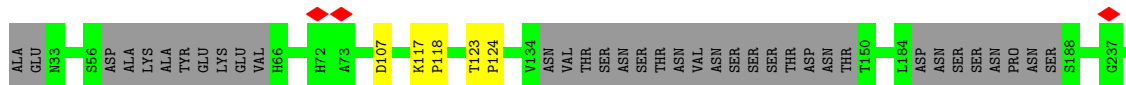

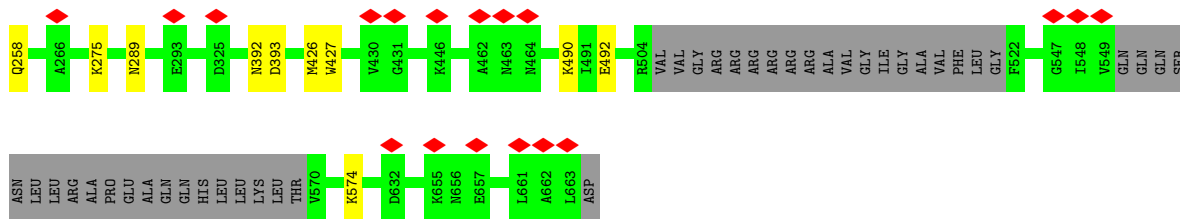

• Molecule 2: VRC01GL light chain

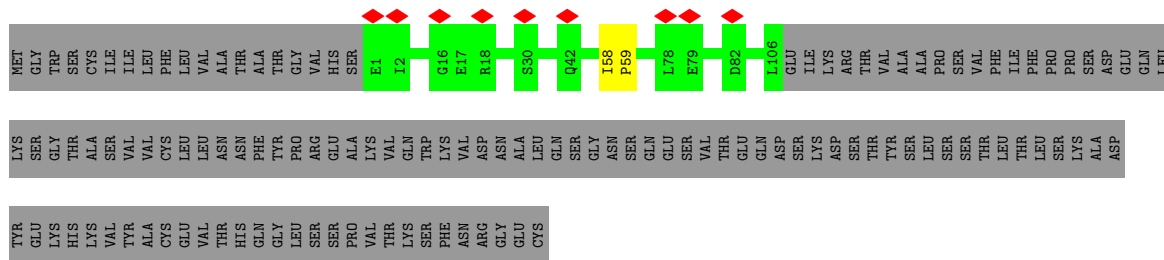

• Molecule 2: VRC01GL light chain

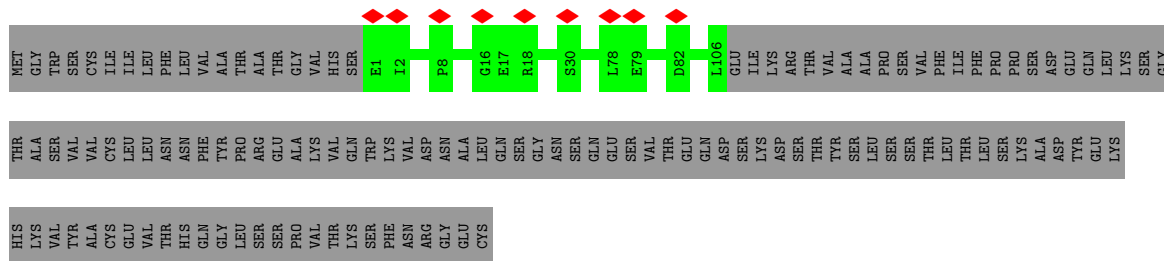

• Molecule 2: VRC01GL light chain

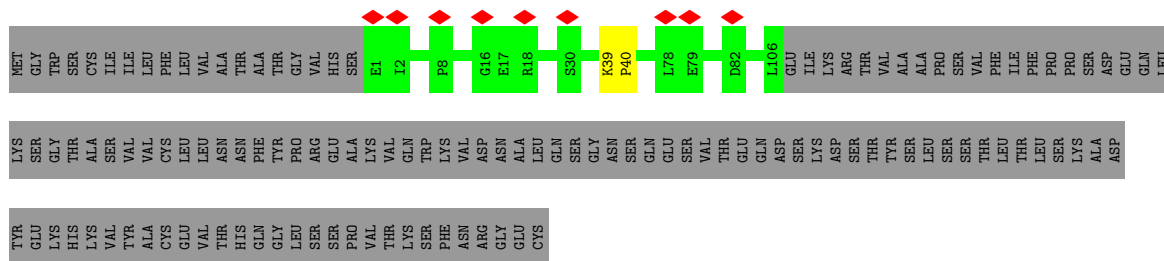

• Molecule 3: VRC01GL heavy chain



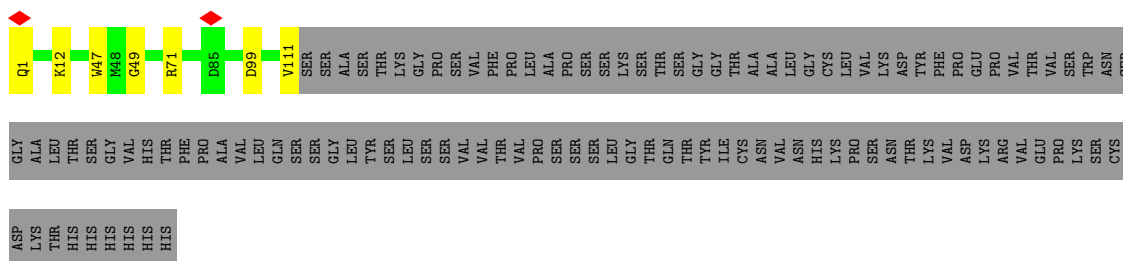

• Molecule 3: VRC01GL heavy chain

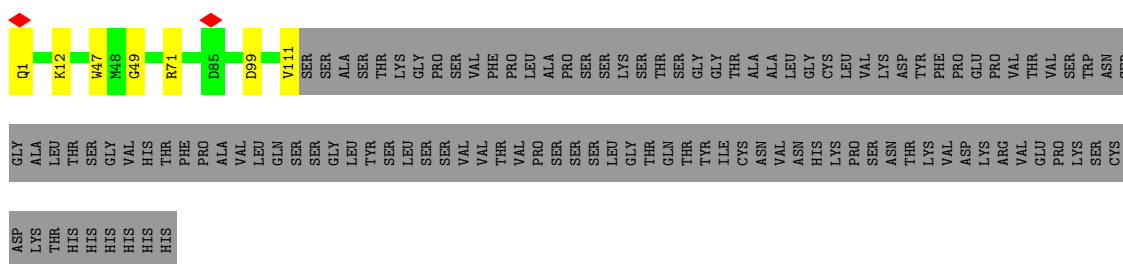

• Molecule 3: VRC01GL heavy chain

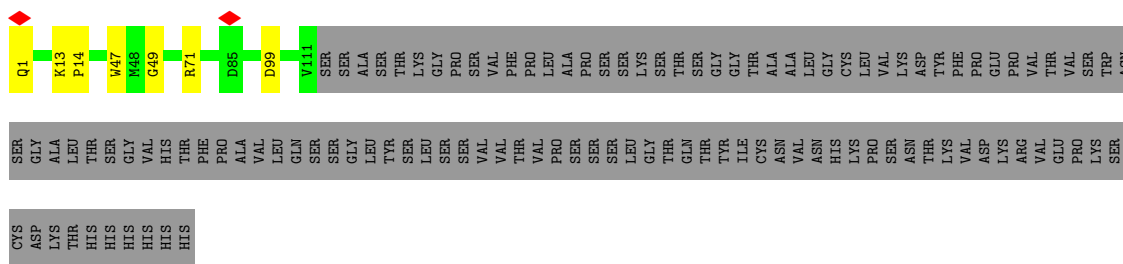

• Molecule 4: 2-acetamido-2-deoxy-beta-D-glucopyranose-(1-4)-2-acetamido-2-deoxy-beta-D-glucopyranose



• Molecule 4: 2-acetamido-2-deoxy-beta-D-glucopyranose-(1-4)-2-acetamido-2-deoxy-beta-D-glucopyranose



- Molecule 4: 2-acetamido-2-deoxy-beta-D-glucopyranose-(1-4)-2-acetamido-2-deoxy-beta-D-glucopyranose



- Molecule 4: 2-acetamido-2-deoxy-beta-D-glucopyranose-(1-4)-2-acetamido-2-deoxy-beta-D-glucopyranose



- Molecule 4: 2-acetamido-2-deoxy-beta-D-glucopyranose-(1-4)-2-acetamido-2-deoxy-beta-D-glucopyranose



- Molecule 4: 2-acetamido-2-deoxy-beta-D-glucopyranose-(1-4)-2-acetamido-2-deoxy-beta-D-glucopyranose



- Molecule 4: 2-acetamido-2-deoxy-beta-D-glucopyranose-(1-4)-2-acetamido-2-deoxy-beta-D-glucopyranose



- Molecule 4: 2-acetamido-2-deoxy-beta-D-glucopyranose-(1-4)-2-acetamido-2-deoxy-beta-D-glucopyranose





- Molecule 4: 2-acetamido-2-deoxy-beta-D-glucopyranose-(1-4)-2-acetamido-2-deoxy-beta-D-glucopyranose



- Molecule 4: 2-acetamido-2-deoxy-beta-D-glucopyranose-(1-4)-2-acetamido-2-deoxy-beta-D-glucopyranose



- Molecule 4: 2-acetamido-2-deoxy-beta-D-glucopyranose-(1-4)-2-acetamido-2-deoxy-beta-D-glucopyranose



- Molecule 4: 2-acetamido-2-deoxy-beta-D-glucopyranose-(1-4)-2-acetamido-2-deoxy-beta-D-glucopyranose



- Molecule 4: 2-acetamido-2-deoxy-beta-D-glucopyranose-(1-4)-2-acetamido-2-deoxy-beta-D-glucopyranose



- Molecule 4: 2-acetamido-2-deoxy-beta-D-glucopyranose-(1-4)-2-acetamido-2-deoxy-beta-D-glucopyranose



- Molecule 4: 2-acetamido-2-deoxy-beta-D-glucopyranose-(1-4)-2-acetamido-2-deoxy-beta-D-glucopyranose



- Molecule 4: 2-acetamido-2-deoxy-beta-D-glucopyranose-(1-4)-2-acetamido-2-deoxy-beta-D-glucopyranose



- Molecule 4: 2-acetamido-2-deoxy-beta-D-glucopyranose-(1-4)-2-acetamido-2-deoxy-beta-D-glucopyranose



- Molecule 4: 2-acetamido-2-deoxy-beta-D-glucopyranose-(1-4)-2-acetamido-2-deoxy-beta-D-glucopyranose



- Molecule 5: alpha-D-mannopyranose-(1-3)-[alpha-D-mannopyranose-(1-6)]beta-D-mannopyranose-(1-4)-2-acetamido-2-deoxy-beta-D-glucopyranose-(1-4)-2-acetamido-2-deoxy-beta-D-glucopyranose

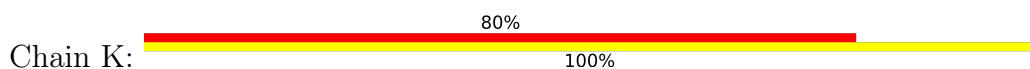

- Molecule 5: alpha-D-mannopyranose-(1-3)-[alpha-D-mannopyranose-(1-6)]beta-D-mannopyranose-(1-4)-2-acetamido-2-deoxy-beta-D-glucopyranose-(1-4)-2-acetamido-2-deoxy-beta-D-glucopyranose

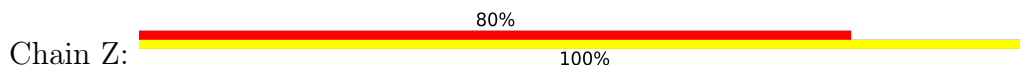

- Molecule 5: alpha-D-mannopyranose-(1-3)-[alpha-D-mannopyranose-(1-6)]beta-D-mannopyranose-(1-4)-2-acetamido-2-deoxy-beta-D-glucopyranose-(1-4)-2-acetamido-2-deoxy-beta-D-glucopyranose

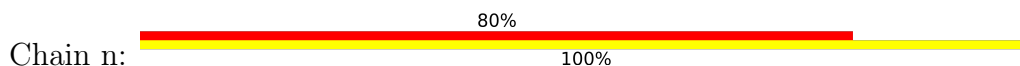

- Molecule 6: alpha-D-mannopyranose-(1-3)-alpha-D-mannopyranose-(1-6)-[alpha-D-mannopyranose-(1-3)]beta-D-mannopyranose-(1-4)-2-acetamido-2-deoxy-beta-D-glucopyranose-(1-4)-2-acetamido-2-deoxy-beta-D-glucopyranose



- Molecule 6: alpha-D-mannopyranose-(1-3)-alpha-D-mannopyranose-(1-6)-[alpha-D-mannopyranose-(1-3)]beta-D-mannopyranose-(1-4)-2-acetamido-2-deoxy-beta-D-glucopyranose-(1-4)-2-acetamido-2-deoxy-beta-D-glucopyranose



- Molecule 6: alpha-D-mannopyranose-(1-3)-alpha-D-mannopyranose-(1-6)-[alpha-D-mannopyranose-(1-3)]beta-D-mannopyranose-(1-4)-2-acetamido-2-deoxy-beta-D-glucopyranose-(1-4)-2-acetamido-2-deoxy-beta-D-glucopyranose



- Molecule 7: beta-D-mannopyranose-(1-4)-2-acetamido-2-deoxy-beta-D-glucopyranose-(1-4)-2-acetamido-2-deoxy-beta-D-glucopyranose

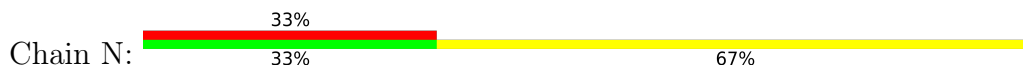

- Molecule 7: beta-D-mannopyranose-(1-4)-2-acetamido-2-deoxy-beta-D-glucopyranose-(1-4)-2-acetamido-2-deoxy-beta-D-glucopyranose



- Molecule 7: beta-D-mannopyranose-(1-4)-2-acetamido-2-deoxy-beta-D-glucopyranose-(1-4)-2-acetamido-2-deoxy-beta-D-glucopyranose



- Molecule 7: beta-D-mannopyranose-(1-4)-2-acetamido-2-deoxy-beta-D-glucopyranose-(1-4)-2-acetamido-2-deoxy-beta-D-glucopyranose



- Molecule 7: beta-D-mannopyranose-(1-4)-2-acetamido-2-deoxy-beta-D-glucopyranose-(1-4)-2-acetamido-2-deoxy-beta-D-glucopyranose



- Molecule 7: beta-D-mannopyranose-(1-4)-2-acetamido-2-deoxy-beta-D-glucopyranose-(1-4)-2-acetamido-2-deoxy-beta-D-glucopyranose



- Molecule 7: beta-D-mannopyranose-(1-4)-2-acetamido-2-deoxy-beta-D-glucopyranose-(1-4)-2-acetamido-2-deoxy-beta-D-glucopyranose



- Molecule 7: beta-D-mannopyranose-(1-4)-2-acetamido-2-deoxy-beta-D-glucopyranose-(1-4)-2-acetamido-2-deoxy-beta-D-glucopyranose



- Molecule 7: beta-D-mannopyranose-(1-4)-2-acetamido-2-deoxy-beta-D-glucopyranose-(1-4)-2-acetamido-2-deoxy-beta-D-glucopyranose



- Molecule 8: alpha-D-mannopyranose-(1-2)-alpha-D-mannopyranose-(1-3)-[alpha-D-mannopyranose-(1-3)-alpha-D-mannopyranose-(1-6)]beta-D-mannopyranose-(1-4)-2-acetamido-2-deoxy-beta-D-glucopyranose-(1-4)-2-acetamido-2-deoxy-beta-D-glucopyranose



- Molecule 8: alpha-D-mannopyranose-(1-2)-alpha-D-mannopyranose-(1-3)-[alpha-D-mannopyranose-(1-3)-alpha-D-mannopyranose-(1-6)]beta-D-mannopyranose-(1-4)-2-acetamido-2-deoxy-beta-D-glucopyranose-(1-4)-2-acetamido-2-deoxy-beta-D-glucopyranose



- Molecule 8: alpha-D-mannopyranose-(1-2)-alpha-D-mannopyranose-(1-3)-[alpha-D-mannopyranose-(1-3)-alpha-D-mannopyranose-(1-6)]beta-D-mannopyranose-(1-4)-2-acetamido-2-deoxy-beta-D-glucopyranose-(1-4)-2-acetamido-2-deoxy-beta-D-glucopyranose



- Molecule 9: alpha-D-mannopyranose-(1-3)-beta-D-mannopyranose-(1-4)-2-acetamido-2-deoxy-beta-D-glucopyranose-(1-4)-2-acetamido-2-deoxy-beta-D-glucopyranose



- Molecule 9: alpha-D-mannopyranose-(1-3)-beta-D-mannopyranose-(1-4)-2-acetamido-2-deoxy-beta-D-glucopyranose-(1-4)-2-acetamido-2-deoxy-beta-D-glucopyranose



- Molecule 9: alpha-D-mannopyranose-(1-3)-beta-D-mannopyranose-(1-4)-2-acetamido-2-deoxy-beta-D-glucopyranose-(1-4)-2-acetamido-2-deoxy-beta-D-glucopyranose



- Molecule 10: alpha-D-mannopyranose-(1-2)-alpha-D-mannopyranose-(1-3)-beta-D-mannopyranose-(1-4)-2-acetamido-2-deoxy-beta-D-glucopyranose-(1-4)-2-acetamido-2-deoxy-beta-D-glucopyranose



- Molecule 10: alpha-D-mannopyranose-(1-2)-alpha-D-mannopyranose-(1-3)-beta-D-mannopyranose-(1-4)-2-acetamido-2-deoxy-beta-D-glucopyranose-(1-4)-2-acetamido-2-deoxy-beta-D-glucopyranose



- Molecule 10: alpha-D-mannopyranose-(1-2)-alpha-D-mannopyranose-(1-3)-beta-D-mannopyranose-(1-4)-2-acetamido-2-deoxy-beta-D-glucopyranose-(1-4)-2-acetamido-2-deoxy-beta-D-glucopyranose

Chain v: 



4 Experimental information

Property	Value	Source
EM reconstruction method	SINGLE PARTICLE	Depositor
Imposed symmetry	POINT, C3	Depositor
Number of particles used	134443	Depositor
Resolution determination method	FSC 0.143 CUT-OFF	Depositor
CTF correction method	PHASE FLIPPING AND AMPLITUDE CORRECTION	Depositor
Microscope	FEI TITAN KRIOS	Depositor
Voltage (kV)	300	Depositor
Electron dose ($e^-/\text{\AA}^2$)	1	Depositor
Minimum defocus (nm)	Not provided	
Maximum defocus (nm)	Not provided	
Magnification	Not provided	
Image detector	GATAN K2 SUMMIT (4k x 4k)	Depositor
Maximum map value	0.322	Depositor
Minimum map value	-0.112	Depositor
Average map value	0.000	Depositor
Map value standard deviation	0.007	Depositor
Recommended contour level	0.08	Depositor
Map size (Å)	435.2, 435.2, 435.2	wwPDB
Map dimensions	320, 320, 320	wwPDB
Map angles (°)	90.0, 90.0, 90.0	wwPDB
Pixel spacing (Å)	1.36, 1.36, 1.36	Depositor

5 Model quality [i](#)

5.1 Standard geometry [i](#)

Bond lengths and bond angles in the following residue types are not validated in this section: PCA, MAN, BMA, NAG

The Z score for a bond length (or angle) is the number of standard deviations the observed value is removed from the expected value. A bond length (or angle) with $|Z| > 5$ is considered an outlier worth inspection. RMSZ is the root-mean-square of all Z scores of the bond lengths (or angles).

Mol	Chain	Bond lengths		Bond angles	
		RMSZ	# Z >5	RMSZ	# Z >5
1	A	0.72	0/4423	0.49	0/6004
1	B	0.72	0/4423	0.49	0/6004
1	E	0.72	0/4423	0.49	0/6004
2	C	0.74	0/785	0.53	0/1067
2	F	0.74	0/785	0.53	0/1067
2	L	0.74	0/785	0.53	0/1067
3	D	0.69	0/958	0.53	0/1300
3	G	0.69	0/958	0.53	0/1300
3	H	0.69	0/958	0.53	0/1300
All	All	0.72	0/18498	0.50	0/25113

There are no bond length outliers.

There are no bond angle outliers.

There are no chirality outliers.

There are no planarity outliers.

5.2 Too-close contacts [i](#)

In the following table, the Non-H and H(model) columns list the number of non-hydrogen atoms and hydrogen atoms in the chain respectively. The H(added) column lists the number of hydrogen atoms added and optimized by MolProbity. The Clashes column lists the number of clashes within the asymmetric unit, whereas Symm-Clashes lists symmetry-related clashes.

Mol	Chain	Non-H	H(model)	H(added)	Clashes	Symm-Clashes
1	A	4338	0	4280	10	0
1	B	4338	0	4280	11	0
1	E	4338	0	4280	10	0
2	C	767	0	740	0	0

Continued on next page...

Continued from previous page...

Mol	Chain	Non-H	H(model)	H(added)	Clashes	Symm-Clashes
2	F	767	0	740	1	0
2	L	767	0	740	1	0
3	D	940	0	887	3	0
3	G	940	0	887	3	0
3	H	940	0	887	3	0
4	I	28	0	25	0	0
4	J	28	0	25	0	0
4	S	28	0	25	0	0
4	U	28	0	25	0	0
4	V	28	0	25	0	0
4	W	28	0	25	0	0
4	X	28	0	25	0	0
4	Y	28	0	25	0	0
4	g	28	0	25	0	0
4	i	28	0	25	0	0
4	j	28	0	25	0	0
4	k	28	0	25	0	0
4	l	28	0	25	0	0
4	m	28	0	25	0	0
4	u	28	0	25	0	0
4	w	28	0	25	0	0
4	x	28	0	25	0	0
4	y	28	0	25	0	0
5	K	61	0	49	0	0
5	Z	61	0	49	0	0
5	n	61	0	49	0	0
6	M	72	0	57	0	0
6	a	72	0	57	0	0
6	o	72	0	57	0	0
7	N	39	0	33	0	0
7	P	39	0	33	0	0
7	Q	39	0	33	0	0
7	b	39	0	33	0	0
7	d	39	0	33	0	0
7	e	39	0	33	0	0
7	p	39	0	33	0	0
7	r	39	0	33	0	0
7	s	39	0	33	0	0
8	O	83	0	66	0	0
8	c	83	0	66	0	0
8	q	83	0	66	0	0
9	R	50	0	41	0	0

Continued on next page...

Continued from previous page...

Mol	Chain	Non-H	H(model)	H(added)	Clashes	Symm-Clashes
9	f	50	0	41	0	0
9	t	50	0	41	0	0
10	T	61	0	50	0	0
10	h	61	0	50	0	0
10	v	61	0	50	0	0
11	A	56	0	52	0	0
11	B	56	0	52	0	0
11	E	56	0	52	0	0
All	All	20139	0	19413	39	0

The all-atom clashscore is defined as the number of clashes found per 1000 atoms (including hydrogen atoms). The all-atom clashscore for this structure is 1.

The worst 5 of 39 close contacts within the same asymmetric unit are listed below, sorted by their clash magnitude.

Atom-1	Atom-2	Interatomic distance (Å)	Clash overlap (Å)
1:B:107:ASP:OD1	1:B:574:LYS:NZ	2.30	0.64
1:E:107:ASP:OD1	1:E:574:LYS:NZ	2.30	0.64
1:A:107:ASP:OD1	1:A:574:LYS:NZ	2.30	0.64
1:B:123:THR:N	1:B:124:PRO:CD	2.67	0.58
1:A:123:THR:N	1:A:124:PRO:CD	2.67	0.57

There are no symmetry-related clashes.

5.3 Torsion angles [i](#)

5.3.1 Protein backbone [i](#)

In the following table, the Percentiles column shows the percent Ramachandran outliers of the chain as a percentile score with respect to all PDB entries followed by that with respect to all EM entries.

The Analysed column shows the number of residues for which the backbone conformation was analysed, and the total number of residues.

Mol	Chain	Analysed	Favoured	Allowed	Outliers	Percentiles
1	A	538/626 (86%)	522 (97%)	15 (3%)	1 (0%)	47 79
1	B	538/626 (86%)	522 (97%)	15 (3%)	1 (0%)	47 79
1	E	538/626 (86%)	522 (97%)	15 (3%)	1 (0%)	47 79

Continued on next page...

Continued from previous page...

Mol	Chain	Analysed	Favoured	Allowed	Outliers	Percentiles	
2	C	98/229 (43%)	93 (95%)	5 (5%)	0	100	100
2	F	98/229 (43%)	93 (95%)	5 (5%)	0	100	100
2	L	98/229 (43%)	93 (95%)	5 (5%)	0	100	100
3	D	117/233 (50%)	112 (96%)	5 (4%)	0	100	100
3	G	117/233 (50%)	112 (96%)	5 (4%)	0	100	100
3	H	117/233 (50%)	112 (96%)	5 (4%)	0	100	100
All	All	2259/3264 (69%)	2181 (96%)	75 (3%)	3 (0%)	54	83

All (3) Ramachandran outliers are listed below:

Mol	Chain	Res	Type
1	A	258	GLN
1	B	258	GLN
1	E	258	GLN

5.3.2 Protein sidechains [i](#)

In the following table, the Percentiles column shows the percent sidechain outliers of the chain as a percentile score with respect to all PDB entries followed by that with respect to all EM entries.

The Analysed column shows the number of residues for which the sidechain conformation was analysed, and the total number of residues.

Mol	Chain	Analysed	Rotameric	Outliers	Percentiles	
1	A	489/554 (88%)	488 (100%)	1 (0%)	93	97
1	B	489/554 (88%)	488 (100%)	1 (0%)	93	97
1	E	489/554 (88%)	489 (100%)	0	100	100
2	C	83/197 (42%)	83 (100%)	0	100	100
2	F	83/197 (42%)	83 (100%)	0	100	100
2	L	83/197 (42%)	83 (100%)	0	100	100
3	D	98/198 (50%)	97 (99%)	1 (1%)	76	86
3	G	98/198 (50%)	97 (99%)	1 (1%)	76	86
3	H	98/198 (50%)	97 (99%)	1 (1%)	76	86
All	All	2010/2847 (71%)	2005 (100%)	5 (0%)	93	97

All (5) residues with a non-rotameric sidechain are listed below:

Mol	Chain	Res	Type
1	A	357	ASN
3	H	71	ARG
1	B	357	ASN
3	D	71	ARG
3	G	71	ARG

Sometimes sidechains can be flipped to improve hydrogen bonding and reduce clashes. All (5) such sidechains are listed below:

Mol	Chain	Res	Type
1	A	229	ASN
2	L	37	GLN
2	C	37	GLN
1	E	229	ASN
2	F	37	GLN

5.3.3 RNA [i](#)

There are no RNA molecules in this entry.

5.4 Non-standard residues in protein, DNA, RNA chains [i](#)

3 non-standard protein/DNA/RNA residues are modelled in this entry.

In the following table, the Counts columns list the number of bonds (or angles) for which Mogul statistics could be retrieved, the number of bonds (or angles) that are observed in the model and the number of bonds (or angles) that are defined in the Chemical Component Dictionary. The Link column lists molecule types, if any, to which the group is linked. The Z score for a bond length (or angle) is the number of standard deviations the observed value is removed from the expected value. A bond length (or angle) with $|Z| > 2$ is considered an outlier worth inspection. RMSZ is the root-mean-square of all Z scores of the bond lengths (or angles).

Mol	Type	Chain	Res	Link	Bond lengths			Bond angles		
					Counts	RMSZ	$\# Z > 2$	Counts	RMSZ	$\# Z > 2$
3	PCA	G	1	3	7,8,9	0.67	0	9,10,12	1.20	1 (11%)
3	PCA	D	1	3	7,8,9	0.67	0	9,10,12	1.21	1 (11%)
3	PCA	H	1	3	7,8,9	0.66	0	9,10,12	1.20	1 (11%)

In the following table, the Chirals column lists the number of chiral outliers, the number of chiral centers analysed, the number of these observed in the model and the number defined in the Chemical Component Dictionary. Similar counts are reported in the Torsion and Rings columns.

'-' means no outliers of that kind were identified.

Mol	Type	Chain	Res	Link	Chirals	Torsions	Rings
3	PCA	G	1	3	-	0/0/11/13	0/1/1/1
3	PCA	D	1	3	-	0/0/11/13	0/1/1/1
3	PCA	H	1	3	-	0/0/11/13	0/1/1/1

There are no bond length outliers.

All (3) bond angle outliers are listed below:

Mol	Chain	Res	Type	Atoms	Z	Observed(°)	Ideal(°)
3	D	1	PCA	CB-CA-C	-2.20	109.67	112.70
3	H	1	PCA	CB-CA-C	-2.18	109.70	112.70
3	G	1	PCA	CB-CA-C	-2.17	109.71	112.70

There are no chirality outliers.

There are no torsion outliers.

There are no ring outliers.

No monomer is involved in short contacts.

5.5 Carbohydrates [i](#)

144 monosaccharides are modelled in this entry.

In the following table, the Counts columns list the number of bonds (or angles) for which Mogul statistics could be retrieved, the number of bonds (or angles) that are observed in the model and the number of bonds (or angles) that are defined in the Chemical Component Dictionary. The Link column lists molecule types, if any, to which the group is linked. The Z score for a bond length (or angle) is the number of standard deviations the observed value is removed from the expected value. A bond length (or angle) with $|Z| > 2$ is considered an outlier worth inspection. RMSZ is the root-mean-square of all Z scores of the bond lengths (or angles).

Mol	Type	Chain	Res	Link	Bond lengths			Bond angles		
					Counts	RMSZ	# Z > 2	Counts	RMSZ	# Z > 2
4	NAG	I	1	4,1	14,14,15	0.80	1 (7%)	17,19,21	1.04	1 (5%)
4	NAG	I	2	4	14,14,15	0.75	0	17,19,21	1.09	1 (5%)
4	NAG	J	1	4,1	14,14,15	0.75	0	17,19,21	0.84	0
4	NAG	J	2	4	14,14,15	0.74	0	17,19,21	1.07	1 (5%)
5	NAG	K	1	5,1	14,14,15	0.79	1 (7%)	17,19,21	0.96	0
5	NAG	K	2	5	14,14,15	0.85	0	17,19,21	1.71	2 (11%)
5	BMA	K	3	5	11,11,12	1.73	4 (36%)	15,15,17	1.40	2 (13%)

Mol	Type	Chain	Res	Link	Bond lengths			Bond angles		
					Counts	RMSZ	# Z > 2	Counts	RMSZ	# Z > 2
5	MAN	K	4	5	11,11,12	1.82	2 (18%)	15,15,17	0.99	1 (6%)
5	MAN	K	5	5	11,11,12	1.82	2 (18%)	15,15,17	1.15	2 (13%)
6	NAG	M	1	6,1	14,14,15	0.81	1 (7%)	17,19,21	1.00	1 (5%)
6	NAG	M	2	6	14,14,15	0.69	0	17,19,21	0.95	1 (5%)
6	BMA	M	3	6	11,11,12	1.88	3 (27%)	15,15,17	1.03	0
6	MAN	M	4	6	11,11,12	1.83	2 (18%)	15,15,17	1.17	2 (13%)
6	MAN	M	5	6	11,11,12	1.84	2 (18%)	15,15,17	1.00	1 (6%)
6	MAN	M	6	6	11,11,12	1.81	2 (18%)	15,15,17	1.01	1 (6%)
7	NAG	N	1	7,1	14,14,15	0.78	0	17,19,21	0.94	0
7	NAG	N	2	7	14,14,15	0.80	0	17,19,21	1.06	1 (5%)
7	BMA	N	3	7	11,11,12	1.84	2 (18%)	15,15,17	0.99	1 (6%)
8	NAG	O	1	8,1	14,14,15	0.79	1 (7%)	17,19,21	1.00	0
8	NAG	O	2	8	14,14,15	0.77	1 (7%)	17,19,21	0.99	0
8	BMA	O	3	8	11,11,12	2.04	4 (36%)	15,15,17	1.45	3 (20%)
8	MAN	O	4	8	11,11,12	1.61	2 (18%)	15,15,17	0.92	0
8	MAN	O	5	8	11,11,12	1.84	2 (18%)	15,15,17	1.04	1 (6%)
8	MAN	O	6	8	11,11,12	1.86	2 (18%)	15,15,17	0.97	1 (6%)
8	MAN	O	7	8	11,11,12	1.83	2 (18%)	15,15,17	0.99	1 (6%)
7	NAG	P	1	7,1	14,14,15	0.79	0	17,19,21	0.90	0
7	NAG	P	2	7	14,14,15	0.85	0	17,19,21	1.47	2 (11%)
7	BMA	P	3	7	11,11,12	1.86	2 (18%)	15,15,17	1.09	1 (6%)
7	NAG	Q	1	7,1	14,14,15	1.03	1 (7%)	17,19,21	0.99	0
7	NAG	Q	2	7	14,14,15	0.81	0	17,19,21	1.02	1 (5%)
7	BMA	Q	3	7	11,11,12	1.85	2 (18%)	15,15,17	1.01	1 (6%)
9	NAG	R	1	1,9	14,14,15	0.77	1 (7%)	17,19,21	0.92	0
9	NAG	R	2	9	14,14,15	0.77	0	17,19,21	0.96	1 (5%)
9	BMA	R	3	9	11,11,12	1.81	2 (18%)	15,15,17	1.11	1 (6%)
9	MAN	R	4	9	11,11,12	1.82	2 (18%)	15,15,17	1.03	1 (6%)
4	NAG	S	1	4,1	14,14,15	0.77	0	17,19,21	0.90	0
4	NAG	S	2	4	14,14,15	0.72	0	17,19,21	1.08	1 (5%)
10	NAG	T	1	10,1	14,14,15	0.80	1 (7%)	17,19,21	0.89	0
10	NAG	T	2	10	14,14,15	0.74	0	17,19,21	1.01	1 (5%)
10	BMA	T	3	10	11,11,12	1.88	2 (18%)	15,15,17	1.13	1 (6%)
10	MAN	T	4	10	11,11,12	1.70	2 (18%)	15,15,17	1.01	1 (6%)
10	MAN	T	5	10	11,11,12	1.83	2 (18%)	15,15,17	1.01	1 (6%)

Mol	Type	Chain	Res	Link	Bond lengths			Bond angles		
					Counts	RMSZ	# Z > 2	Counts	RMSZ	# Z > 2
4	NAG	U	1	4,1	14,14,15	0.81	1 (7%)	17,19,21	0.93	1 (5%)
4	NAG	U	2	4	14,14,15	0.72	0	17,19,21	0.99	1 (5%)
4	NAG	V	1	4,1	14,14,15	0.71	0	17,19,21	0.81	0
4	NAG	V	2	4	14,14,15	0.75	0	17,19,21	1.14	1 (5%)
4	NAG	W	1	4,1	14,14,15	0.82	1 (7%)	17,19,21	1.00	1 (5%)
4	NAG	W	2	4	14,14,15	0.72	0	17,19,21	1.03	1 (5%)
4	NAG	X	1	4,1	14,14,15	0.80	1 (7%)	17,19,21	1.04	1 (5%)
4	NAG	X	2	4	14,14,15	0.74	0	17,19,21	1.09	1 (5%)
4	NAG	Y	1	4,1	14,14,15	0.75	0	17,19,21	0.84	0
4	NAG	Y	2	4	14,14,15	0.74	0	17,19,21	1.07	1 (5%)
5	NAG	Z	1	5,1	14,14,15	0.80	1 (7%)	17,19,21	0.96	0
5	NAG	Z	2	5	14,14,15	0.85	1 (7%)	17,19,21	1.71	2 (11%)
5	BMA	Z	3	5	11,11,12	1.72	4 (36%)	15,15,17	1.40	2 (13%)
5	MAN	Z	4	5	11,11,12	1.83	2 (18%)	15,15,17	0.98	0
5	MAN	Z	5	5	11,11,12	1.82	2 (18%)	15,15,17	1.15	1 (6%)
6	NAG	a	1	6,1	14,14,15	0.81	1 (7%)	17,19,21	1.01	1 (5%)
6	NAG	a	2	6	14,14,15	0.69	0	17,19,21	0.94	1 (5%)
6	BMA	a	3	6	11,11,12	1.86	3 (27%)	15,15,17	1.03	0
6	MAN	a	4	6	11,11,12	1.83	2 (18%)	15,15,17	1.17	2 (13%)
6	MAN	a	5	6	11,11,12	1.84	2 (18%)	15,15,17	1.00	1 (6%)
6	MAN	a	6	6	11,11,12	1.81	2 (18%)	15,15,17	1.01	1 (6%)
7	NAG	b	1	7,1	14,14,15	0.79	0	17,19,21	0.94	0
7	NAG	b	2	7	14,14,15	0.80	0	17,19,21	1.06	1 (5%)
7	BMA	b	3	7	11,11,12	1.83	2 (18%)	15,15,17	0.99	1 (6%)
8	NAG	c	1	8,1	14,14,15	0.79	1 (7%)	17,19,21	0.99	0
8	NAG	c	2	8	14,14,15	0.78	1 (7%)	17,19,21	0.99	0
8	BMA	c	3	8	11,11,12	2.04	4 (36%)	15,15,17	1.45	3 (20%)
8	MAN	c	4	8	11,11,12	1.62	2 (18%)	15,15,17	0.92	0
8	MAN	c	5	8	11,11,12	1.85	2 (18%)	15,15,17	1.04	1 (6%)
8	MAN	c	6	8	11,11,12	1.86	2 (18%)	15,15,17	0.97	1 (6%)
8	MAN	c	7	8	11,11,12	1.84	2 (18%)	15,15,17	1.00	1 (6%)
7	NAG	d	1	7,1	14,14,15	0.78	0	17,19,21	0.90	0
7	NAG	d	2	7	14,14,15	0.86	0	17,19,21	1.47	2 (11%)
7	BMA	d	3	7	11,11,12	1.85	2 (18%)	15,15,17	1.09	1 (6%)
7	NAG	e	1	7,1	14,14,15	1.03	1 (7%)	17,19,21	0.99	0

Mol	Type	Chain	Res	Link	Bond lengths			Bond angles		
					Counts	RMSZ	# Z > 2	Counts	RMSZ	# Z > 2
7	NAG	e	2	7	14,14,15	0.81	0	17,19,21	1.02	1 (5%)
7	BMA	e	3	7	11,11,12	1.87	2 (18%)	15,15,17	1.01	1 (6%)
9	NAG	f	1	1,9	14,14,15	0.77	1 (7%)	17,19,21	0.92	0
9	NAG	f	2	9	14,14,15	0.77	0	17,19,21	0.96	1 (5%)
9	BMA	f	3	9	11,11,12	1.82	2 (18%)	15,15,17	1.10	1 (6%)
9	MAN	f	4	9	11,11,12	1.83	2 (18%)	15,15,17	1.02	1 (6%)
4	NAG	g	1	4,1	14,14,15	0.77	0	17,19,21	0.90	0
4	NAG	g	2	4	14,14,15	0.73	0	17,19,21	1.08	1 (5%)
10	NAG	h	1	10,1	14,14,15	0.80	1 (7%)	17,19,21	0.89	0
10	NAG	h	2	10	14,14,15	0.75	0	17,19,21	1.01	1 (5%)
10	BMA	h	3	10	11,11,12	1.88	2 (18%)	15,15,17	1.12	1 (6%)
10	MAN	h	4	10	11,11,12	1.70	2 (18%)	15,15,17	1.01	1 (6%)
10	MAN	h	5	10	11,11,12	1.83	2 (18%)	15,15,17	1.01	1 (6%)
4	NAG	i	1	4,1	14,14,15	0.83	1 (7%)	17,19,21	0.92	1 (5%)
4	NAG	i	2	4	14,14,15	0.72	0	17,19,21	1.00	1 (5%)
4	NAG	j	1	4,1	14,14,15	0.73	0	17,19,21	0.81	0
4	NAG	j	2	4	14,14,15	0.75	0	17,19,21	1.14	1 (5%)
4	NAG	k	1	4,1	14,14,15	0.82	1 (7%)	17,19,21	1.01	1 (5%)
4	NAG	k	2	4	14,14,15	0.72	0	17,19,21	1.02	1 (5%)
4	NAG	l	1	4,1	14,14,15	0.80	1 (7%)	17,19,21	1.04	1 (5%)
4	NAG	l	2	4	14,14,15	0.74	0	17,19,21	1.09	1 (5%)
4	NAG	m	1	4,1	14,14,15	0.76	0	17,19,21	0.84	0
4	NAG	m	2	4	14,14,15	0.75	0	17,19,21	1.07	1 (5%)
5	NAG	n	1	5,1	14,14,15	0.79	1 (7%)	17,19,21	0.96	0
5	NAG	n	2	5	14,14,15	0.84	0	17,19,21	1.72	2 (11%)
5	BMA	n	3	5	11,11,12	1.73	4 (36%)	15,15,17	1.40	2 (13%)
5	MAN	n	4	5	11,11,12	1.83	2 (18%)	15,15,17	0.98	0
5	MAN	n	5	5	11,11,12	1.82	2 (18%)	15,15,17	1.15	1 (6%)
6	NAG	o	1	6,1	14,14,15	0.80	1 (7%)	17,19,21	1.00	1 (5%)
6	NAG	o	2	6	14,14,15	0.70	0	17,19,21	0.94	1 (5%)
6	BMA	o	3	6	11,11,12	1.88	3 (27%)	15,15,17	1.04	0
6	MAN	o	4	6	11,11,12	1.82	2 (18%)	15,15,17	1.17	2 (13%)
6	MAN	o	5	6	11,11,12	1.85	2 (18%)	15,15,17	1.00	1 (6%)
6	MAN	o	6	6	11,11,12	1.81	2 (18%)	15,15,17	1.00	1 (6%)
7	NAG	p	1	7,1	14,14,15	0.78	0	17,19,21	0.94	0

Mol	Type	Chain	Res	Link	Bond lengths			Bond angles		
					Counts	RMSZ	# Z > 2	Counts	RMSZ	# Z > 2
7	NAG	p	2	7	14,14,15	0.79	0	17,19,21	1.06	1 (5%)
7	BMA	p	3	7	11,11,12	1.83	2 (18%)	15,15,17	0.99	1 (6%)
8	NAG	q	1	8,1	14,14,15	0.79	1 (7%)	17,19,21	1.00	0
8	NAG	q	2	8	14,14,15	0.78	1 (7%)	17,19,21	0.99	0
8	BMA	q	3	8	11,11,12	2.03	4 (36%)	15,15,17	1.45	3 (20%)
8	MAN	q	4	8	11,11,12	1.62	2 (18%)	15,15,17	0.92	0
8	MAN	q	5	8	11,11,12	1.85	2 (18%)	15,15,17	1.03	1 (6%)
8	MAN	q	6	8	11,11,12	1.87	2 (18%)	15,15,17	0.98	1 (6%)
8	MAN	q	7	8	11,11,12	1.83	2 (18%)	15,15,17	1.00	1 (6%)
7	NAG	r	1	7,1	14,14,15	0.78	0	17,19,21	0.90	0
7	NAG	r	2	7	14,14,15	0.85	0	17,19,21	1.47	2 (11%)
7	BMA	r	3	7	11,11,12	1.85	2 (18%)	15,15,17	1.09	1 (6%)
7	NAG	s	1	7,1	14,14,15	1.04	1 (7%)	17,19,21	0.99	0
7	NAG	s	2	7	14,14,15	0.81	0	17,19,21	1.01	1 (5%)
7	BMA	s	3	7	11,11,12	1.86	2 (18%)	15,15,17	1.00	1 (6%)
9	NAG	t	1	1,9	14,14,15	0.77	1 (7%)	17,19,21	0.92	0
9	NAG	t	2	9	14,14,15	0.76	0	17,19,21	0.95	1 (5%)
9	BMA	t	3	9	11,11,12	1.82	2 (18%)	15,15,17	1.11	1 (6%)
9	MAN	t	4	9	11,11,12	1.82	2 (18%)	15,15,17	1.03	1 (6%)
4	NAG	u	1	4,1	14,14,15	0.78	0	17,19,21	0.91	0
4	NAG	u	2	4	14,14,15	0.71	0	17,19,21	1.09	1 (5%)
10	NAG	v	1	10,1	14,14,15	0.81	1 (7%)	17,19,21	0.89	0
10	NAG	v	2	10	14,14,15	0.75	0	17,19,21	1.00	1 (5%)
10	BMA	v	3	10	11,11,12	1.89	2 (18%)	15,15,17	1.13	1 (6%)
10	MAN	v	4	10	11,11,12	1.70	2 (18%)	15,15,17	1.00	1 (6%)
10	MAN	v	5	10	11,11,12	1.84	2 (18%)	15,15,17	1.01	1 (6%)
4	NAG	w	1	4,1	14,14,15	0.82	1 (7%)	17,19,21	0.92	1 (5%)
4	NAG	w	2	4	14,14,15	0.73	0	17,19,21	0.99	1 (5%)
4	NAG	x	1	4,1	14,14,15	0.73	0	17,19,21	0.81	0
4	NAG	x	2	4	14,14,15	0.76	0	17,19,21	1.13	1 (5%)
4	NAG	y	1	4,1	14,14,15	0.82	1 (7%)	17,19,21	1.00	1 (5%)
4	NAG	y	2	4	14,14,15	0.72	0	17,19,21	1.02	1 (5%)

In the following table, the Chirals column lists the number of chiral outliers, the number of chiral centers analysed, the number of these observed in the model and the number defined in the Chemical Component Dictionary. Similar counts are reported in the Torsion and Rings columns.

'-' means no outliers of that kind were identified.

Mol	Type	Chain	Res	Link	Chirals	Torsions	Rings
4	NAG	I	1	4,1	-	0/6/23/26	0/1/1/1
4	NAG	I	2	4	-	2/6/23/26	0/1/1/1
4	NAG	J	1	4,1	-	0/6/23/26	0/1/1/1
4	NAG	J	2	4	-	2/6/23/26	0/1/1/1
5	NAG	K	1	5,1	-	0/6/23/26	0/1/1/1
5	NAG	K	2	5	-	0/6/23/26	0/1/1/1
5	BMA	K	3	5	-	2/2/19/22	0/1/1/1
5	MAN	K	4	5	-	0/2/19/22	0/1/1/1
5	MAN	K	5	5	-	2/2/19/22	0/1/1/1
6	NAG	M	1	6,1	-	1/6/23/26	0/1/1/1
6	NAG	M	2	6	-	2/6/23/26	0/1/1/1
6	BMA	M	3	6	-	2/2/19/22	0/1/1/1
6	MAN	M	4	6	-	2/2/19/22	0/1/1/1
6	MAN	M	5	6	-	2/2/19/22	0/1/1/1
6	MAN	M	6	6	-	2/2/19/22	0/1/1/1
7	NAG	N	1	7,1	-	0/6/23/26	0/1/1/1
7	NAG	N	2	7	-	0/6/23/26	0/1/1/1
7	BMA	N	3	7	-	1/2/19/22	0/1/1/1
8	NAG	O	1	8,1	-	2/6/23/26	0/1/1/1
8	NAG	O	2	8	-	0/6/23/26	0/1/1/1
8	BMA	O	3	8	-	1/2/19/22	0/1/1/1
8	MAN	O	4	8	-	2/2/19/22	0/1/1/1
8	MAN	O	5	8	-	2/2/19/22	0/1/1/1
8	MAN	O	6	8	-	2/2/19/22	0/1/1/1
8	MAN	O	7	8	-	2/2/19/22	0/1/1/1
7	NAG	P	1	7,1	-	1/6/23/26	0/1/1/1
7	NAG	P	2	7	-	3/6/23/26	0/1/1/1
7	BMA	P	3	7	-	1/2/19/22	0/1/1/1
7	NAG	Q	1	7,1	-	0/6/23/26	0/1/1/1
7	NAG	Q	2	7	-	2/6/23/26	0/1/1/1
7	BMA	Q	3	7	-	1/2/19/22	0/1/1/1
9	NAG	R	1	1,9	-	1/6/23/26	0/1/1/1
9	NAG	R	2	9	-	2/6/23/26	0/1/1/1
9	BMA	R	3	9	-	2/2/19/22	0/1/1/1
9	MAN	R	4	9	-	2/2/19/22	0/1/1/1
4	NAG	S	1	4,1	-	0/6/23/26	0/1/1/1
4	NAG	S	2	4	-	2/6/23/26	0/1/1/1

Continued on next page...

Continued from previous page...

Mol	Type	Chain	Res	Link	Chirals	Torsions	Rings
10	NAG	T	1	10,1	-	2/6/23/26	0/1/1/1
10	NAG	T	2	10	-	0/6/23/26	0/1/1/1
10	BMA	T	3	10	-	2/2/19/22	0/1/1/1
10	MAN	T	4	10	-	2/2/19/22	0/1/1/1
10	MAN	T	5	10	-	1/2/19/22	0/1/1/1
4	NAG	U	1	4,1	-	0/6/23/26	0/1/1/1
4	NAG	U	2	4	-	2/6/23/26	0/1/1/1
4	NAG	V	1	4,1	-	0/6/23/26	0/1/1/1
4	NAG	V	2	4	-	2/6/23/26	0/1/1/1
4	NAG	W	1	4,1	-	1/6/23/26	0/1/1/1
4	NAG	W	2	4	-	2/6/23/26	0/1/1/1
4	NAG	X	1	4,1	-	0/6/23/26	0/1/1/1
4	NAG	X	2	4	-	2/6/23/26	0/1/1/1
4	NAG	Y	1	4,1	-	0/6/23/26	0/1/1/1
4	NAG	Y	2	4	-	2/6/23/26	0/1/1/1
5	NAG	Z	1	5,1	-	0/6/23/26	0/1/1/1
5	NAG	Z	2	5	-	0/6/23/26	0/1/1/1
5	BMA	Z	3	5	-	2/2/19/22	0/1/1/1
5	MAN	Z	4	5	-	0/2/19/22	0/1/1/1
5	MAN	Z	5	5	-	2/2/19/22	0/1/1/1
6	NAG	a	1	6,1	-	1/6/23/26	0/1/1/1
6	NAG	a	2	6	-	2/6/23/26	0/1/1/1
6	BMA	a	3	6	-	2/2/19/22	0/1/1/1
6	MAN	a	4	6	-	2/2/19/22	0/1/1/1
6	MAN	a	5	6	-	2/2/19/22	0/1/1/1
6	MAN	a	6	6	-	2/2/19/22	0/1/1/1
7	NAG	b	1	7,1	-	0/6/23/26	0/1/1/1
7	NAG	b	2	7	-	0/6/23/26	0/1/1/1
7	BMA	b	3	7	-	1/2/19/22	0/1/1/1
8	NAG	c	1	8,1	-	2/6/23/26	0/1/1/1
8	NAG	c	2	8	-	0/6/23/26	0/1/1/1
8	BMA	c	3	8	-	1/2/19/22	0/1/1/1
8	MAN	c	4	8	-	2/2/19/22	0/1/1/1
8	MAN	c	5	8	-	2/2/19/22	0/1/1/1
8	MAN	c	6	8	-	2/2/19/22	0/1/1/1
8	MAN	c	7	8	-	2/2/19/22	0/1/1/1
7	NAG	d	1	7,1	-	1/6/23/26	0/1/1/1

Continued on next page...

Continued from previous page...

Mol	Type	Chain	Res	Link	Chirals	Torsions	Rings
7	NAG	d	2	7	-	3/6/23/26	0/1/1/1
7	BMA	d	3	7	-	1/2/19/22	0/1/1/1
7	NAG	e	1	7,1	-	0/6/23/26	0/1/1/1
7	NAG	e	2	7	-	2/6/23/26	0/1/1/1
7	BMA	e	3	7	-	1/2/19/22	0/1/1/1
9	NAG	f	1	1,9	-	1/6/23/26	0/1/1/1
9	NAG	f	2	9	-	2/6/23/26	0/1/1/1
9	BMA	f	3	9	-	2/2/19/22	0/1/1/1
9	MAN	f	4	9	-	2/2/19/22	0/1/1/1
4	NAG	g	1	4,1	-	0/6/23/26	0/1/1/1
4	NAG	g	2	4	-	2/6/23/26	0/1/1/1
10	NAG	h	1	10,1	-	2/6/23/26	0/1/1/1
10	NAG	h	2	10	-	0/6/23/26	0/1/1/1
10	BMA	h	3	10	-	2/2/19/22	0/1/1/1
10	MAN	h	4	10	-	2/2/19/22	0/1/1/1
10	MAN	h	5	10	-	1/2/19/22	0/1/1/1
4	NAG	i	1	4,1	-	0/6/23/26	0/1/1/1
4	NAG	i	2	4	-	2/6/23/26	0/1/1/1
4	NAG	j	1	4,1	-	0/6/23/26	0/1/1/1
4	NAG	j	2	4	-	2/6/23/26	0/1/1/1
4	NAG	k	1	4,1	-	1/6/23/26	0/1/1/1
4	NAG	k	2	4	-	2/6/23/26	0/1/1/1
4	NAG	l	1	4,1	-	0/6/23/26	0/1/1/1
4	NAG	l	2	4	-	2/6/23/26	0/1/1/1
4	NAG	m	1	4,1	-	0/6/23/26	0/1/1/1
4	NAG	m	2	4	-	2/6/23/26	0/1/1/1
5	NAG	n	1	5,1	-	0/6/23/26	0/1/1/1
5	NAG	n	2	5	-	0/6/23/26	0/1/1/1
5	BMA	n	3	5	-	2/2/19/22	0/1/1/1
5	MAN	n	4	5	-	0/2/19/22	0/1/1/1
5	MAN	n	5	5	-	2/2/19/22	0/1/1/1
6	NAG	o	1	6,1	-	1/6/23/26	0/1/1/1
6	NAG	o	2	6	-	2/6/23/26	0/1/1/1
6	BMA	o	3	6	-	2/2/19/22	0/1/1/1
6	MAN	o	4	6	-	2/2/19/22	0/1/1/1
6	MAN	o	5	6	-	2/2/19/22	0/1/1/1
6	MAN	o	6	6	-	2/2/19/22	0/1/1/1

Continued on next page...

Continued from previous page...

Mol	Type	Chain	Res	Link	Chirals	Torsions	Rings
7	NAG	p	1	7,1	-	0/6/23/26	0/1/1/1
7	NAG	p	2	7	-	0/6/23/26	0/1/1/1
7	BMA	p	3	7	-	1/2/19/22	0/1/1/1
8	NAG	q	1	8,1	-	2/6/23/26	0/1/1/1
8	NAG	q	2	8	-	0/6/23/26	0/1/1/1
8	BMA	q	3	8	-	1/2/19/22	0/1/1/1
8	MAN	q	4	8	-	2/2/19/22	0/1/1/1
8	MAN	q	5	8	-	2/2/19/22	0/1/1/1
8	MAN	q	6	8	-	2/2/19/22	0/1/1/1
8	MAN	q	7	8	-	2/2/19/22	0/1/1/1
7	NAG	r	1	7,1	-	1/6/23/26	0/1/1/1
7	NAG	r	2	7	-	3/6/23/26	0/1/1/1
7	BMA	r	3	7	-	1/2/19/22	0/1/1/1
7	NAG	s	1	7,1	-	0/6/23/26	0/1/1/1
7	NAG	s	2	7	-	2/6/23/26	0/1/1/1
7	BMA	s	3	7	-	1/2/19/22	0/1/1/1
9	NAG	t	1	1,9	-	1/6/23/26	0/1/1/1
9	NAG	t	2	9	-	2/6/23/26	0/1/1/1
9	BMA	t	3	9	-	2/2/19/22	0/1/1/1
9	MAN	t	4	9	-	2/2/19/22	0/1/1/1
4	NAG	u	1	4,1	-	0/6/23/26	0/1/1/1
4	NAG	u	2	4	-	2/6/23/26	0/1/1/1
10	NAG	v	1	10,1	-	2/6/23/26	0/1/1/1
10	NAG	v	2	10	-	0/6/23/26	0/1/1/1
10	BMA	v	3	10	-	2/2/19/22	0/1/1/1
10	MAN	v	4	10	-	2/2/19/22	0/1/1/1
10	MAN	v	5	10	-	1/2/19/22	0/1/1/1
4	NAG	w	1	4,1	-	0/6/23/26	0/1/1/1
4	NAG	w	2	4	-	2/6/23/26	0/1/1/1
4	NAG	x	1	4,1	-	0/6/23/26	0/1/1/1
4	NAG	x	2	4	-	2/6/23/26	0/1/1/1
4	NAG	y	1	4,1	-	1/6/23/26	0/1/1/1
4	NAG	y	2	4	-	2/6/23/26	0/1/1/1

The worst 5 of 166 bond length outliers are listed below:

Mol	Chain	Res	Type	Atoms	Z	Observed(Å)	Ideal(Å)
7	P	3	BMA	O2-C2	-4.21	1.34	1.43

Continued on next page...

Continued from previous page...

Mol	Chain	Res	Type	Atoms	Z	Observed(Å)	Ideal(Å)
7	r	3	BMA	O2-C2	-4.19	1.34	1.43
7	b	3	BMA	O2-C2	-4.18	1.34	1.43
7	N	3	BMA	O2-C2	-4.18	1.34	1.43
7	p	3	BMA	O2-C2	-4.18	1.34	1.43

The worst 5 of 122 bond angle outliers are listed below:

Mol	Chain	Res	Type	Atoms	Z	Observed(°)	Ideal(°)
5	n	2	NAG	C4-C3-C2	-5.36	103.16	111.02
5	K	2	NAG	C4-C3-C2	-5.35	103.18	111.02
5	Z	2	NAG	C4-C3-C2	-5.34	103.20	111.02
7	r	2	NAG	C4-C3-C2	-4.12	104.97	111.02
7	d	2	NAG	C4-C3-C2	-4.12	104.98	111.02

There are no chirality outliers.

5 of 186 torsion outliers are listed below:

Mol	Chain	Res	Type	Atoms
6	M	6	MAN	C4-C5-C6-O6
6	a	6	MAN	C4-C5-C6-O6
6	o	6	MAN	C4-C5-C6-O6
7	Q	2	NAG	O5-C5-C6-O6
7	e	2	NAG	O5-C5-C6-O6

There are no ring outliers.

No monomer is involved in short contacts.

The following is a two-dimensional graphical depiction of Mogul quality analysis of bond lengths, bond angles, torsion angles, and ring geometry for oligosaccharide.

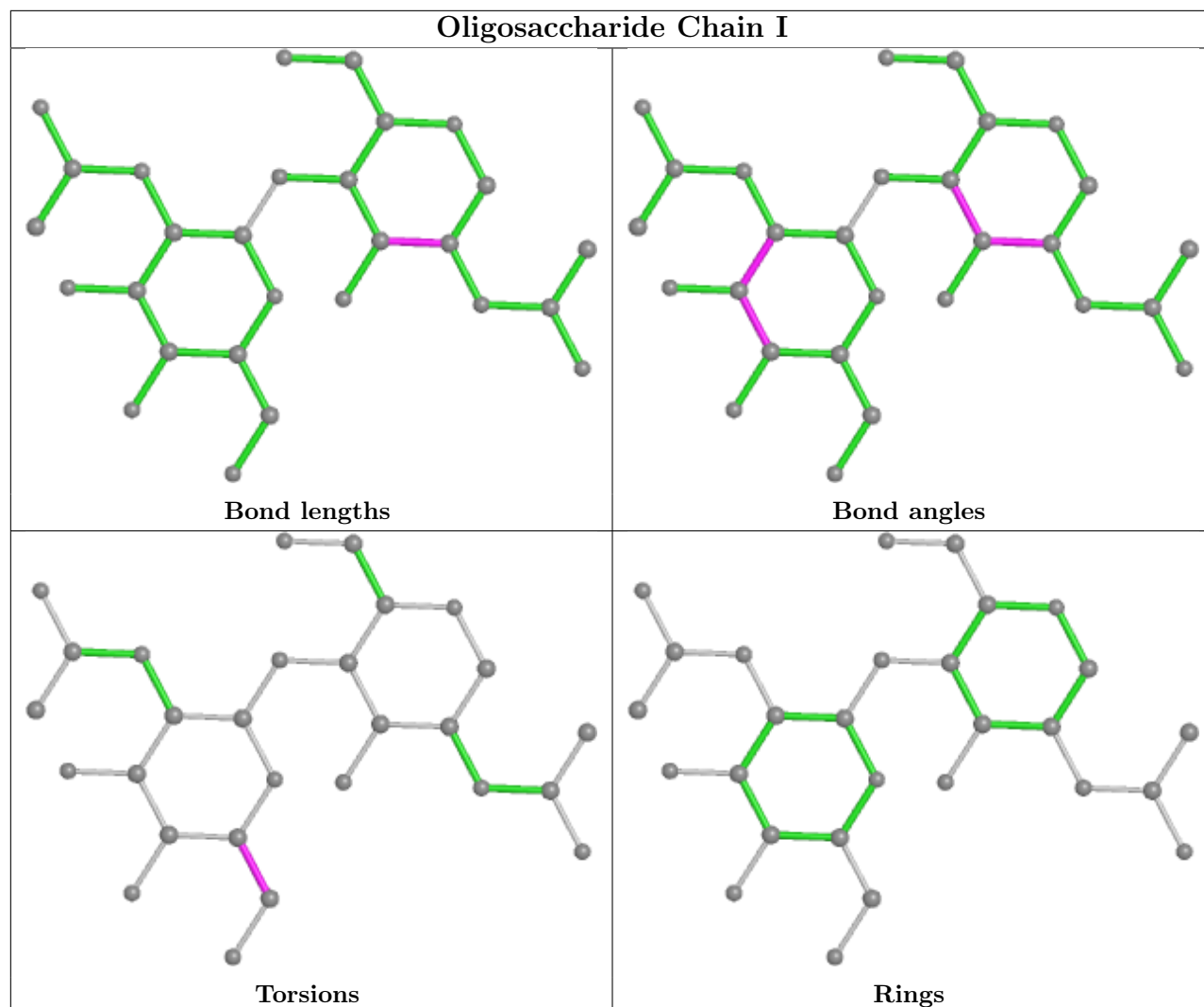

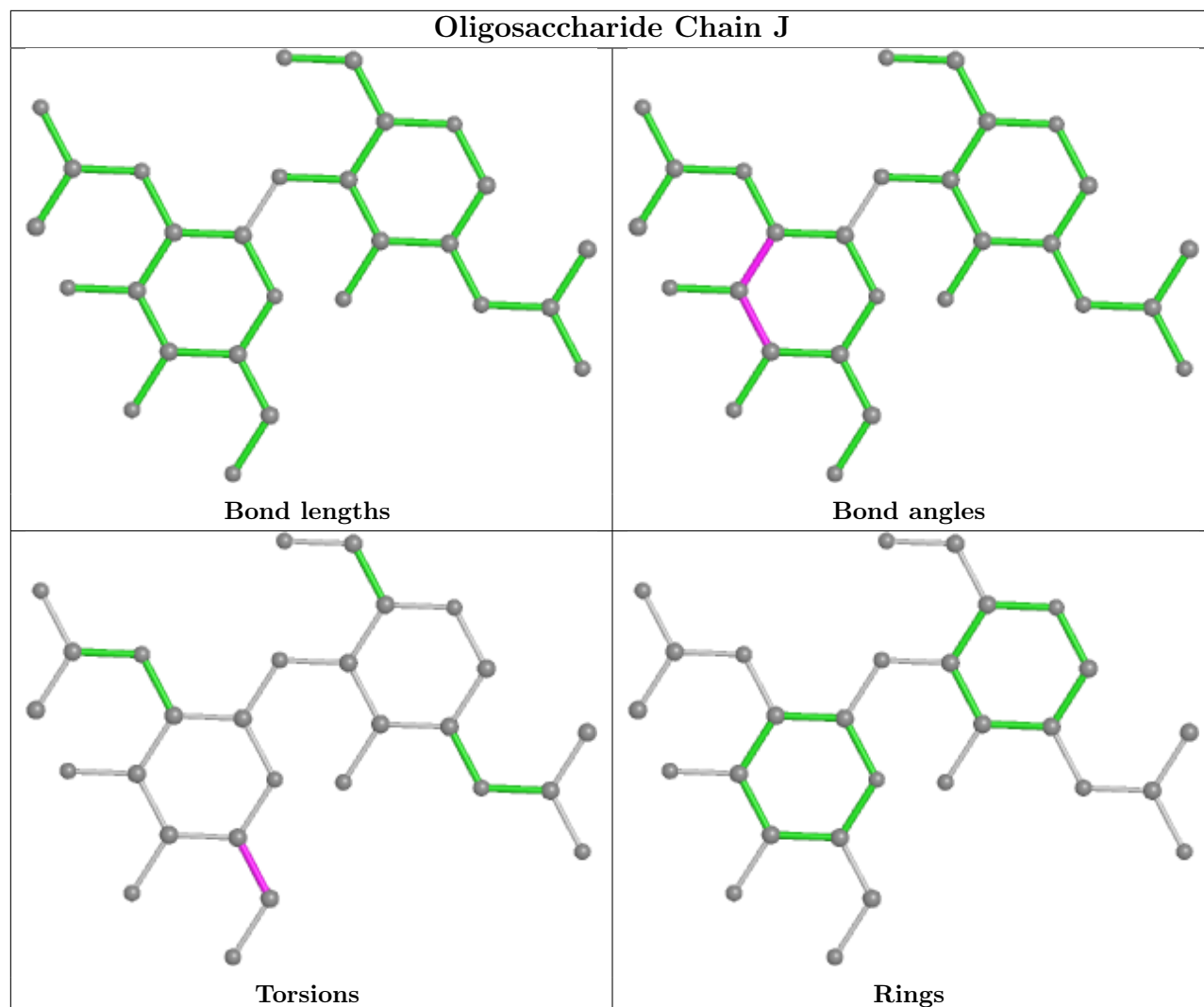

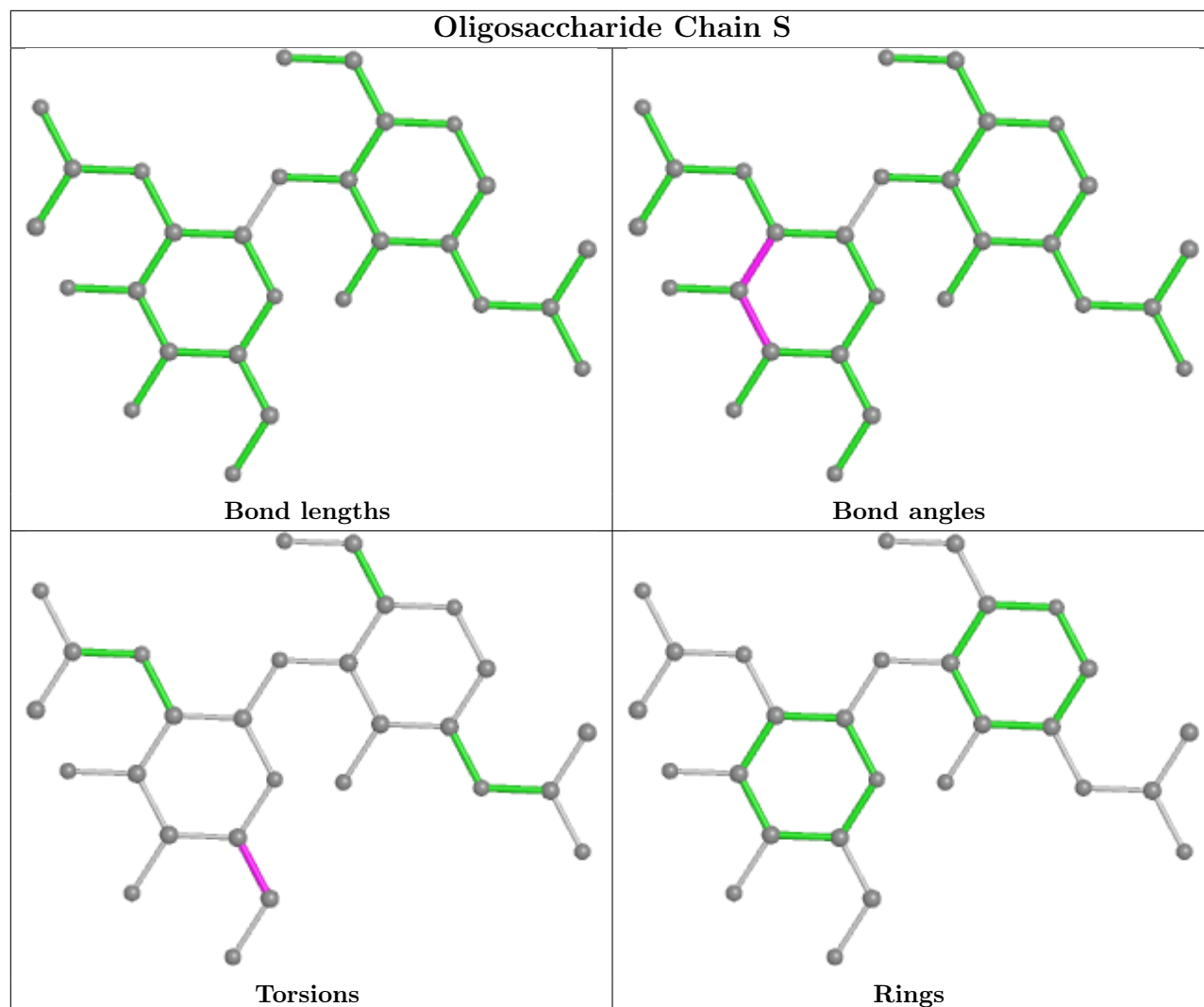

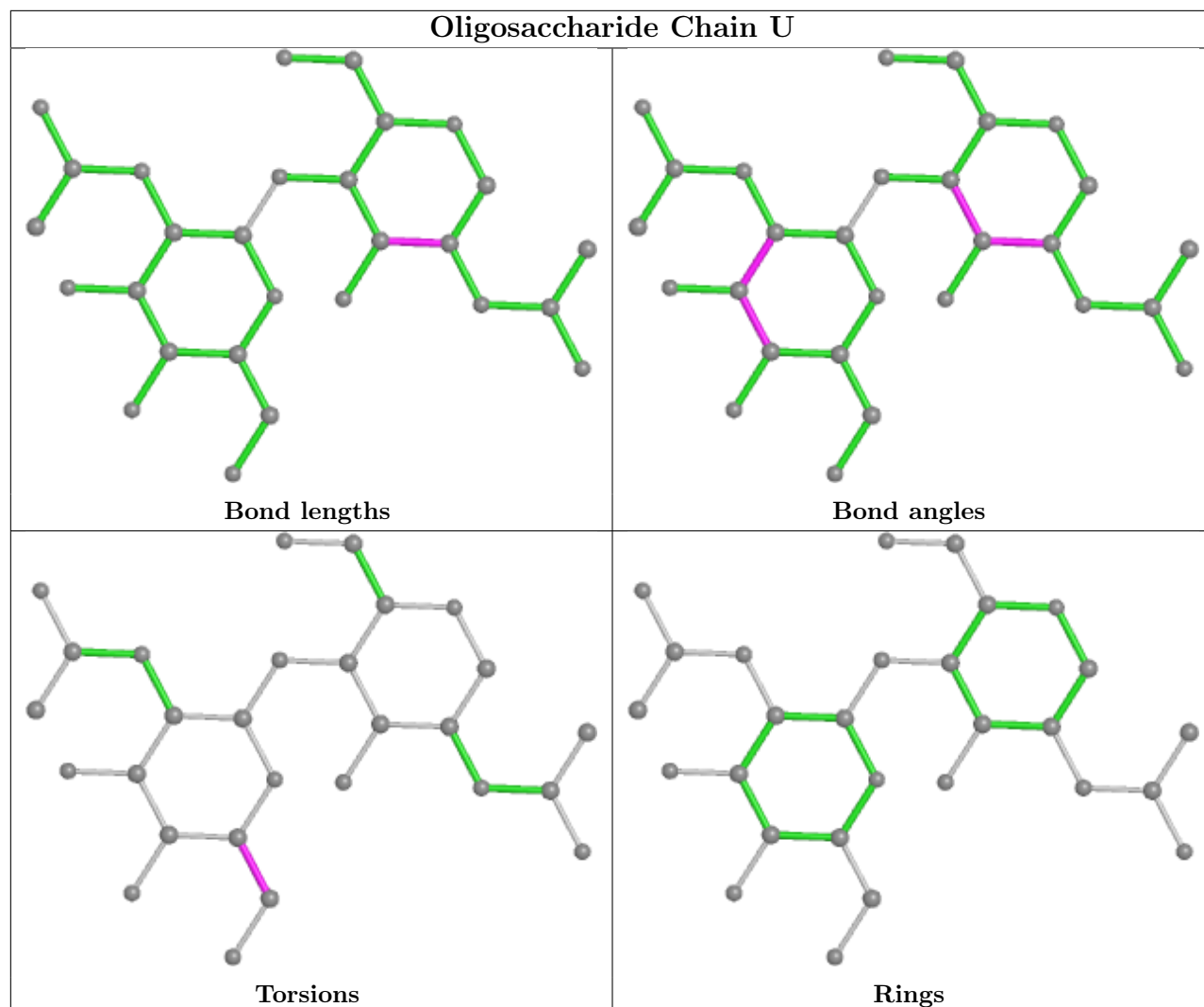

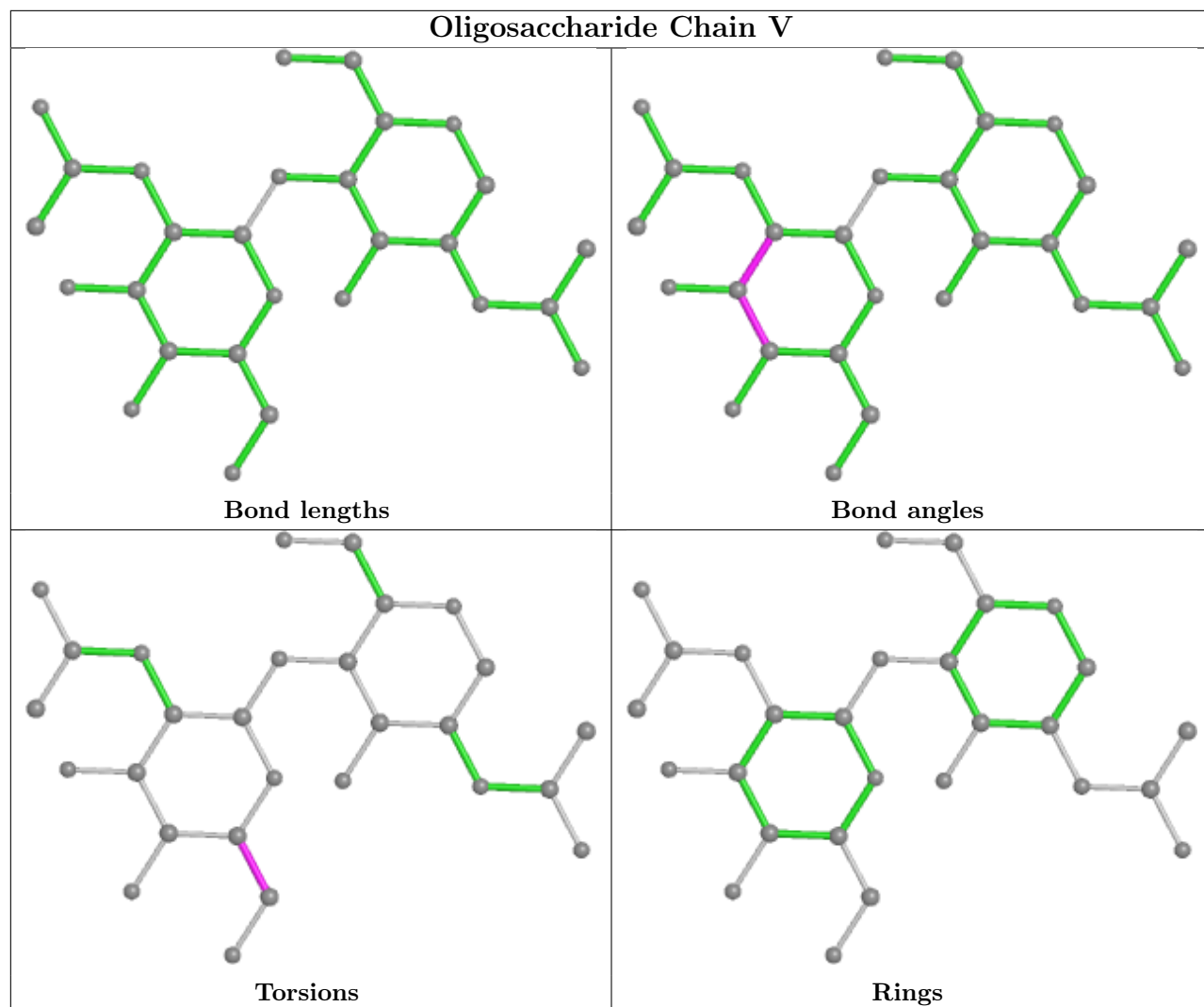

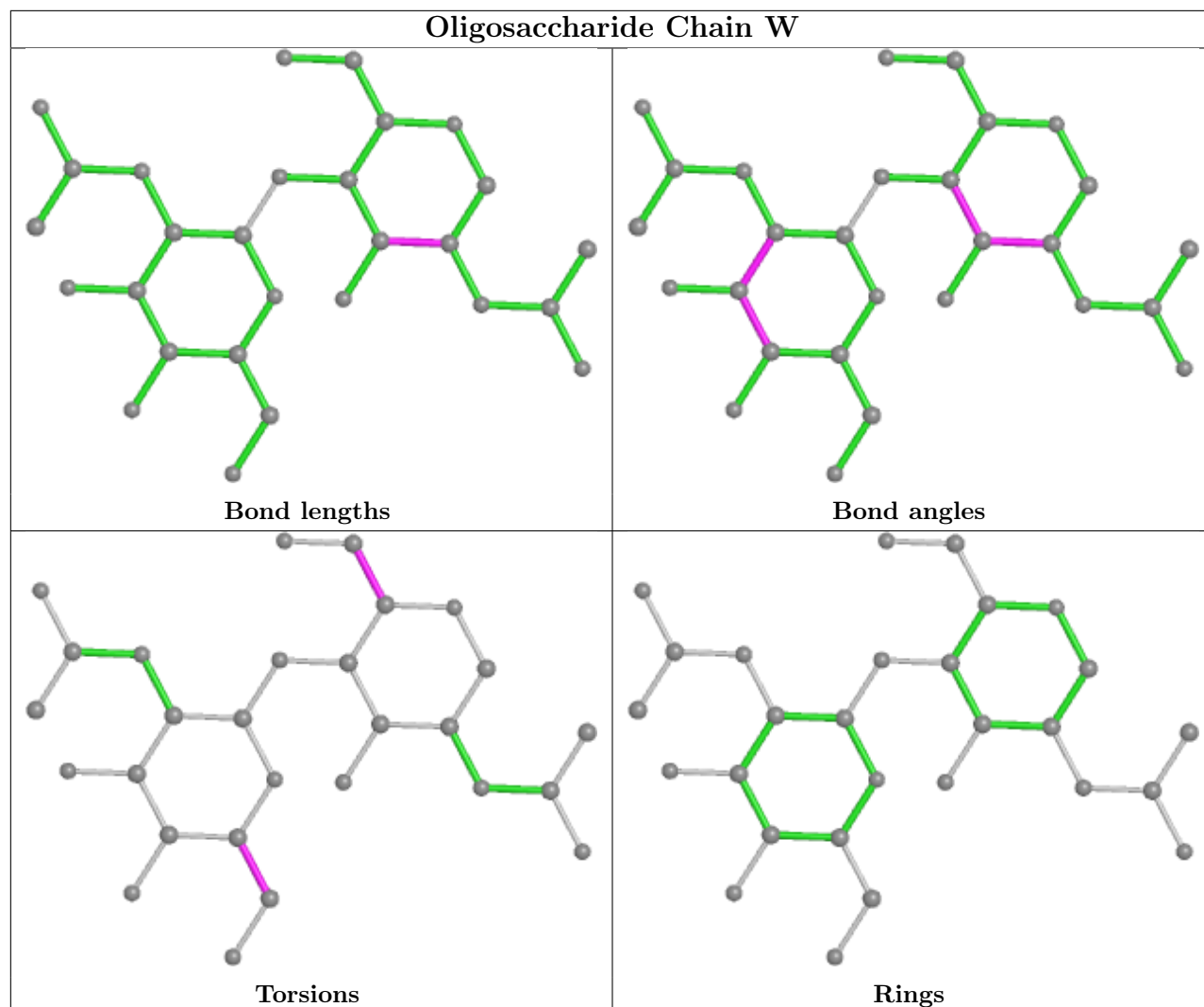

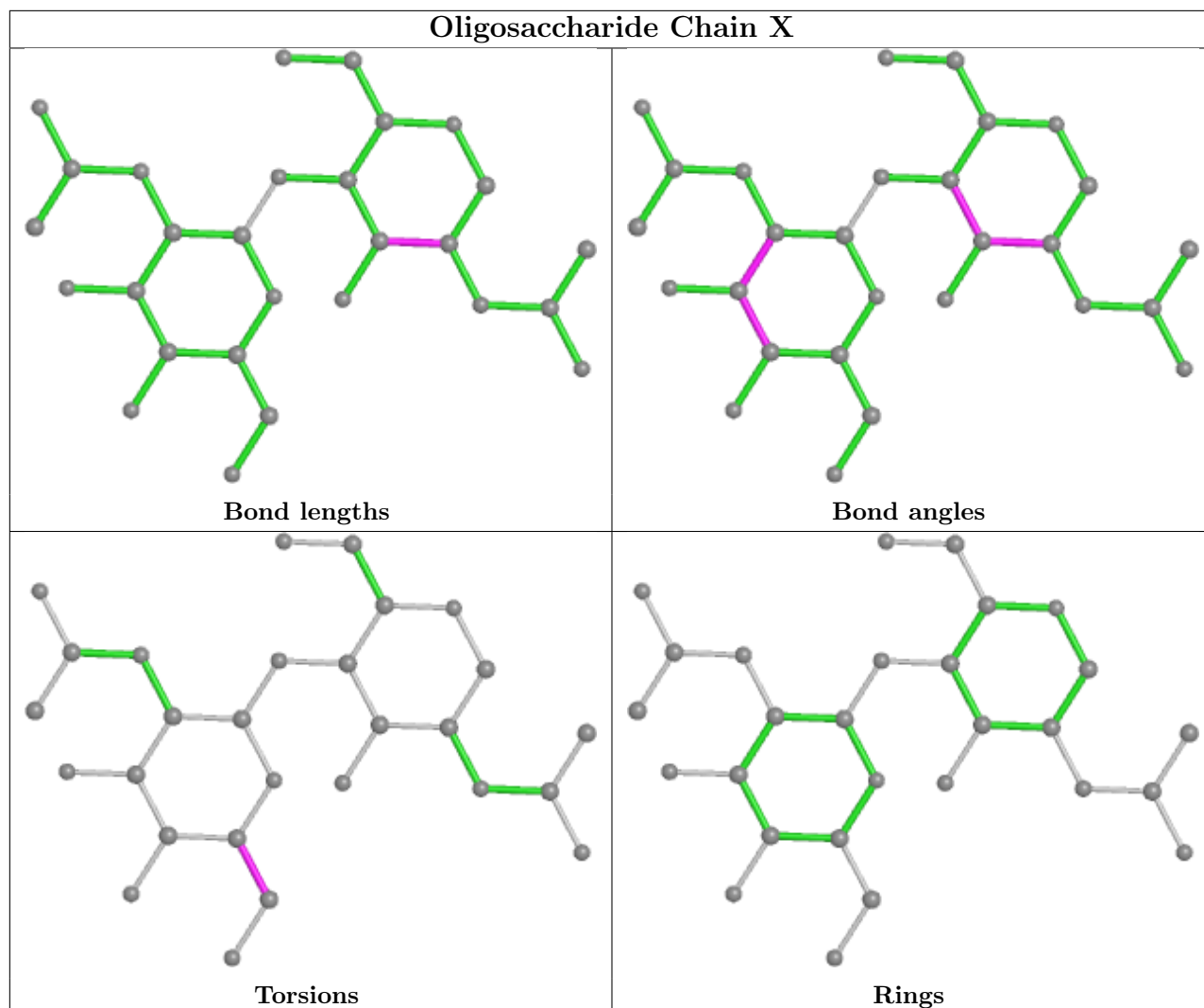

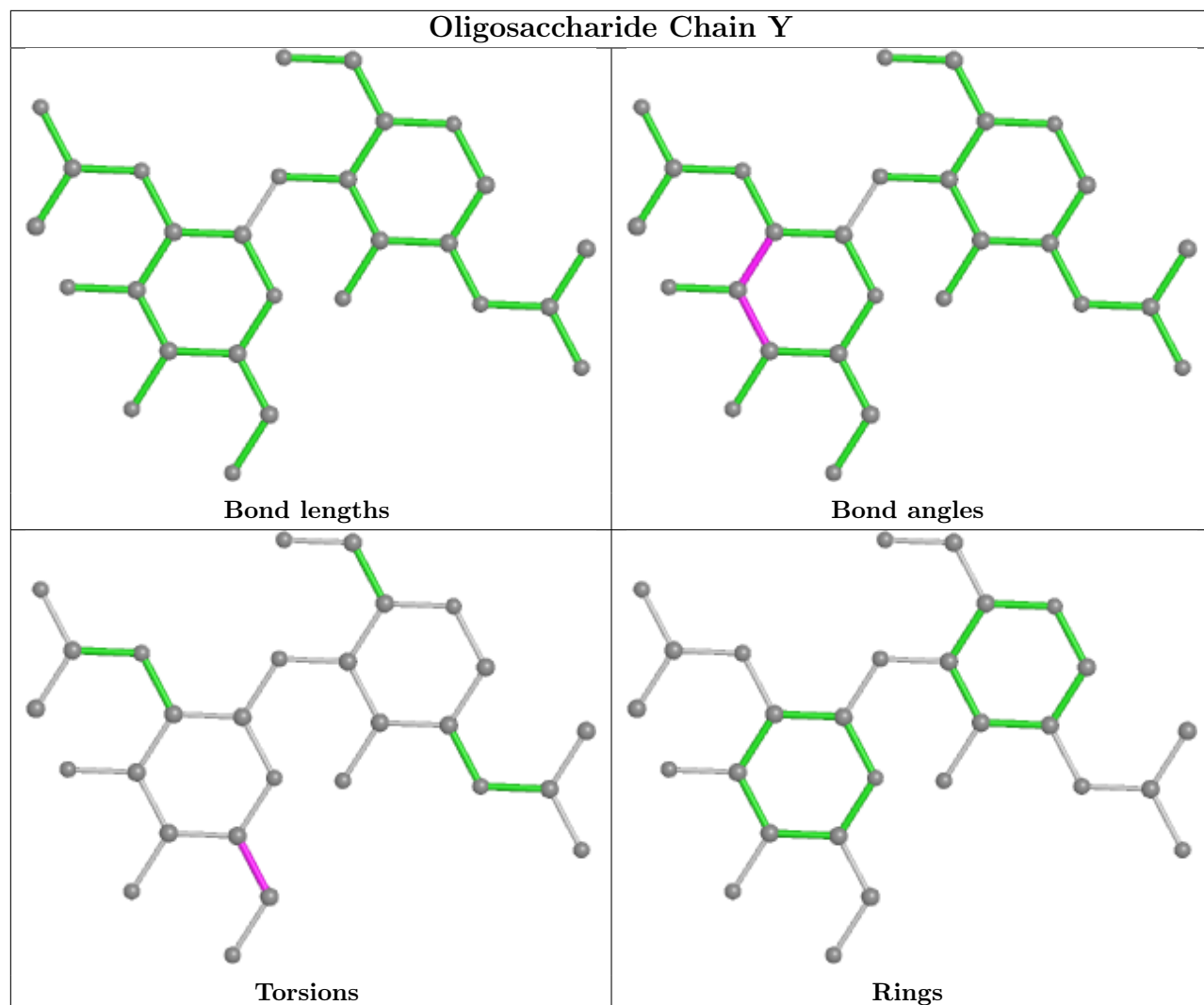

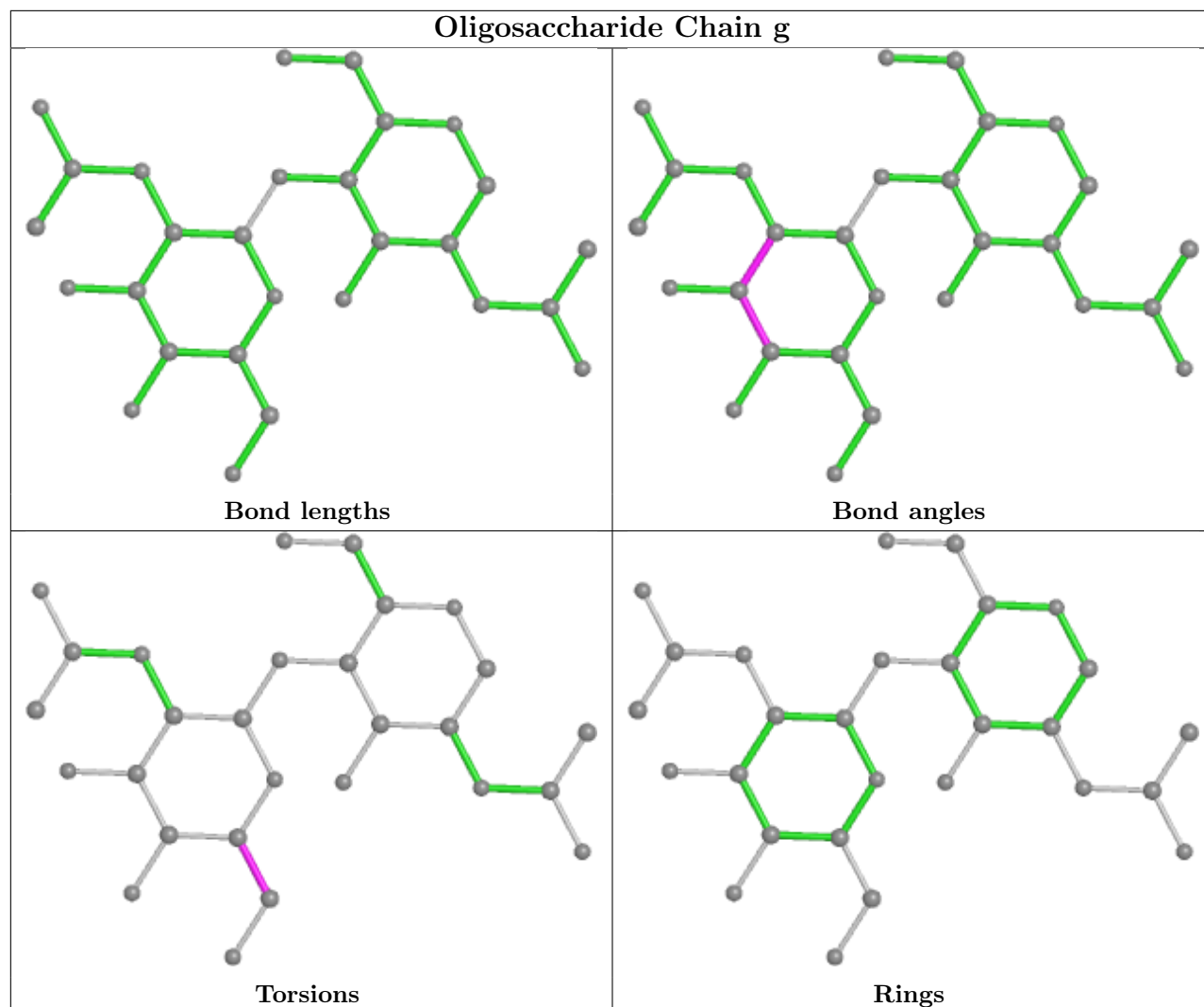

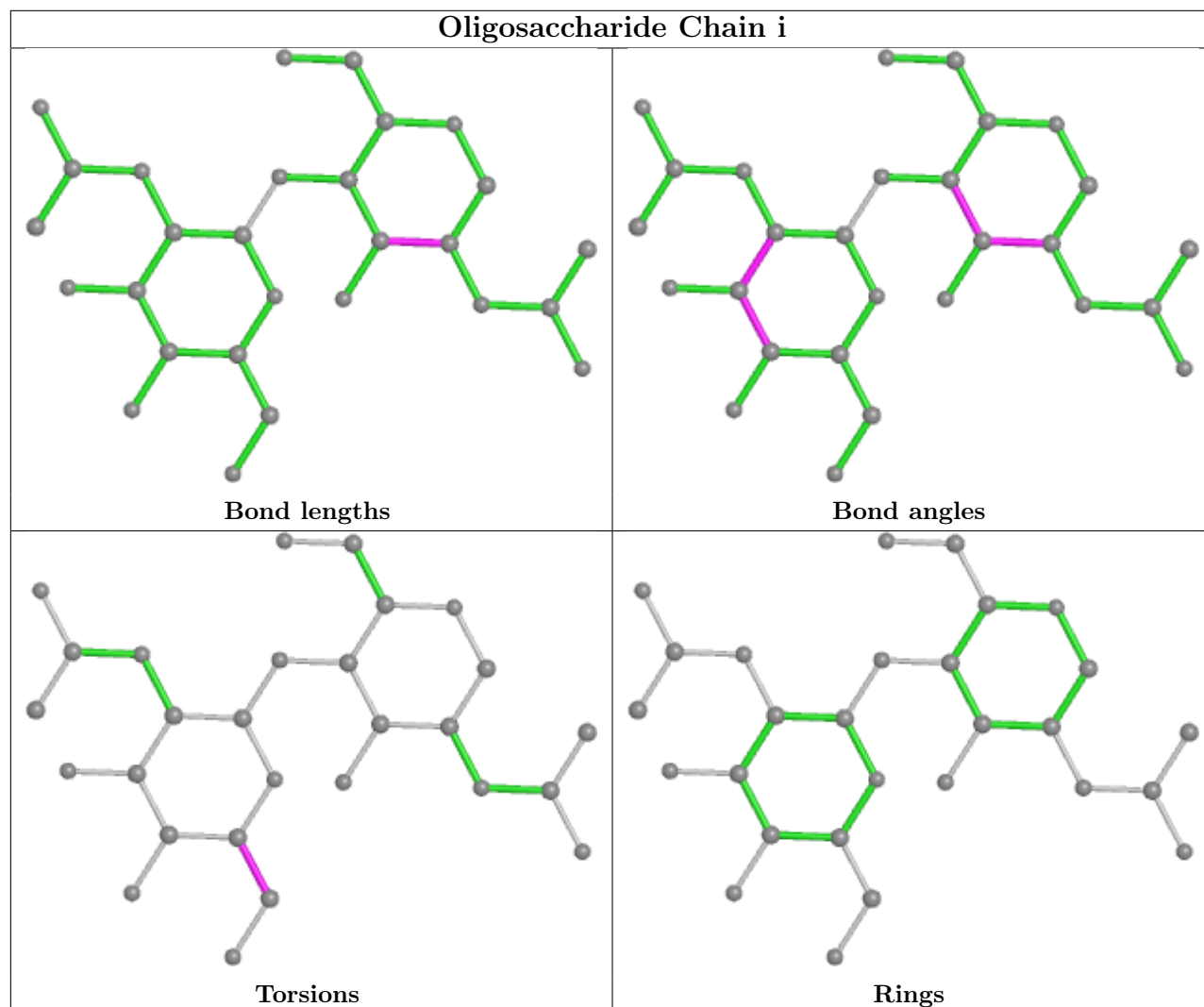

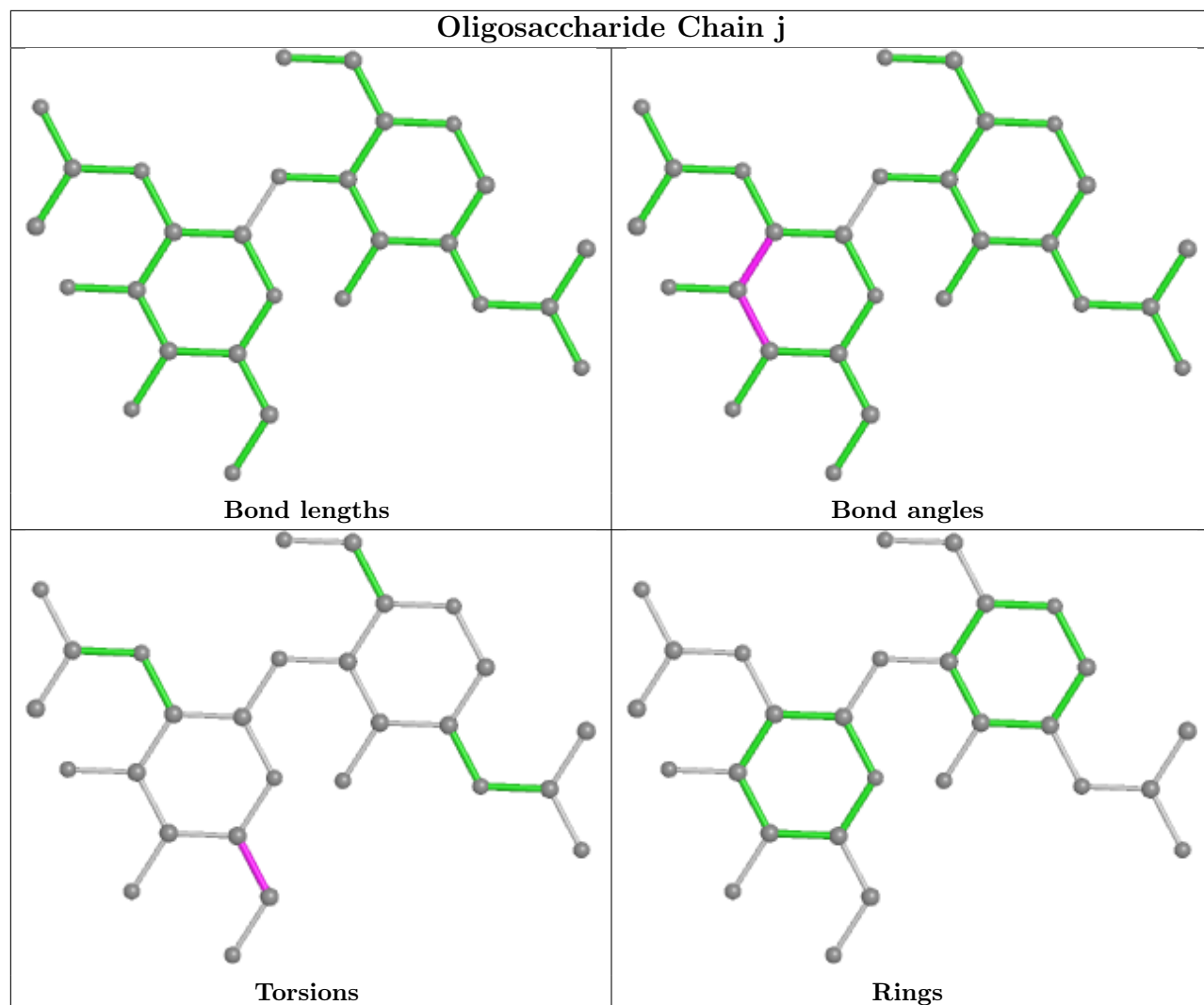

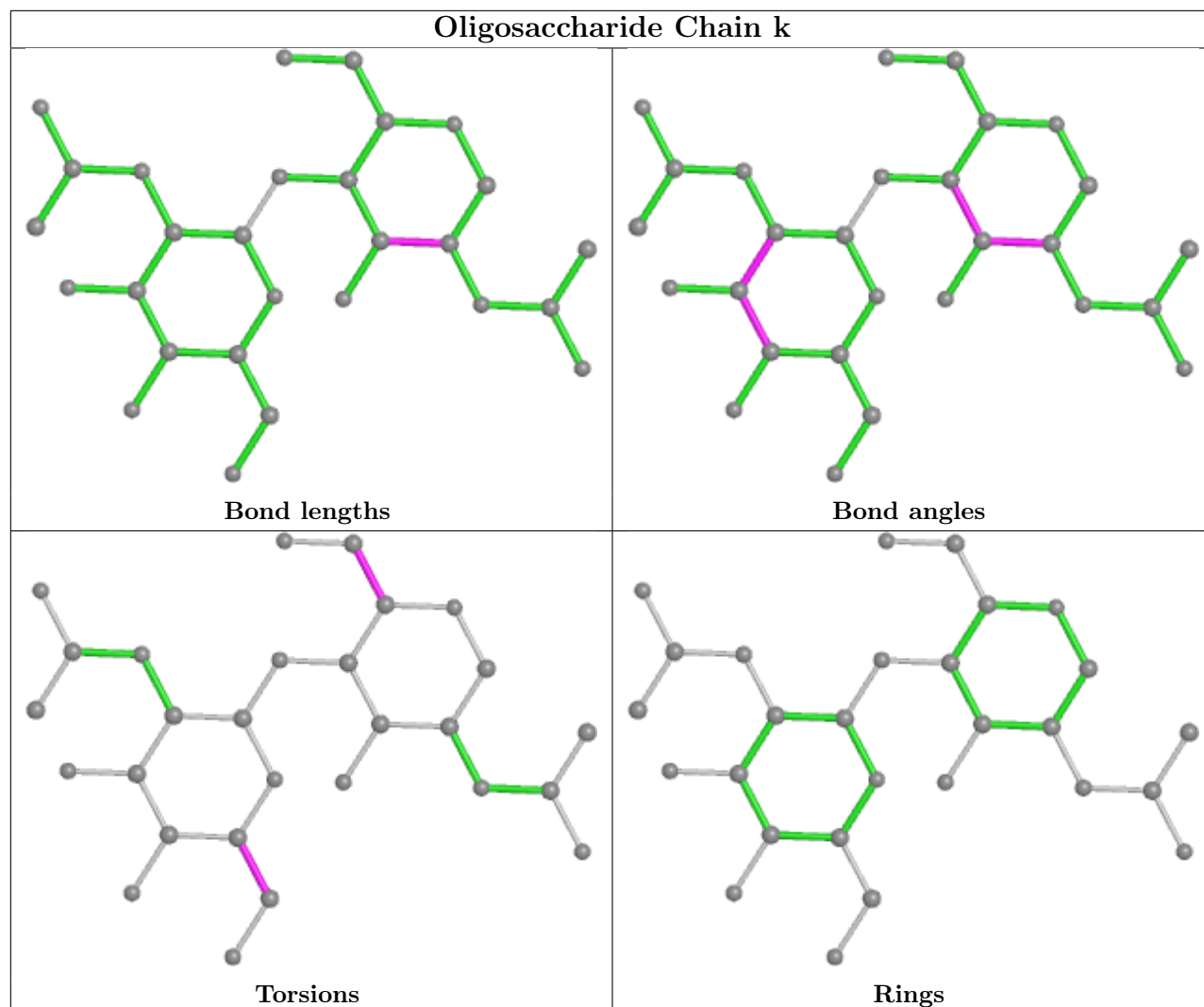

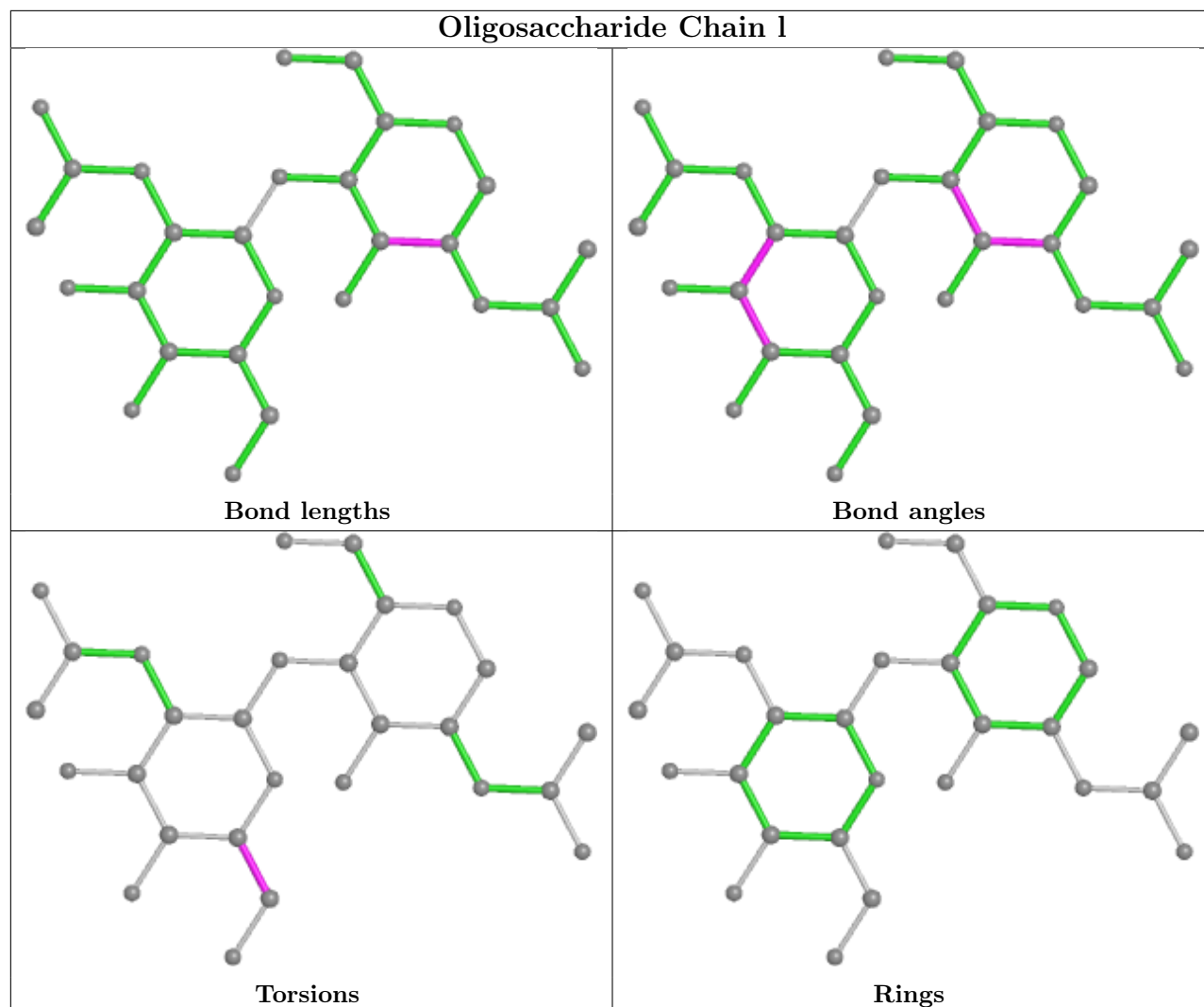

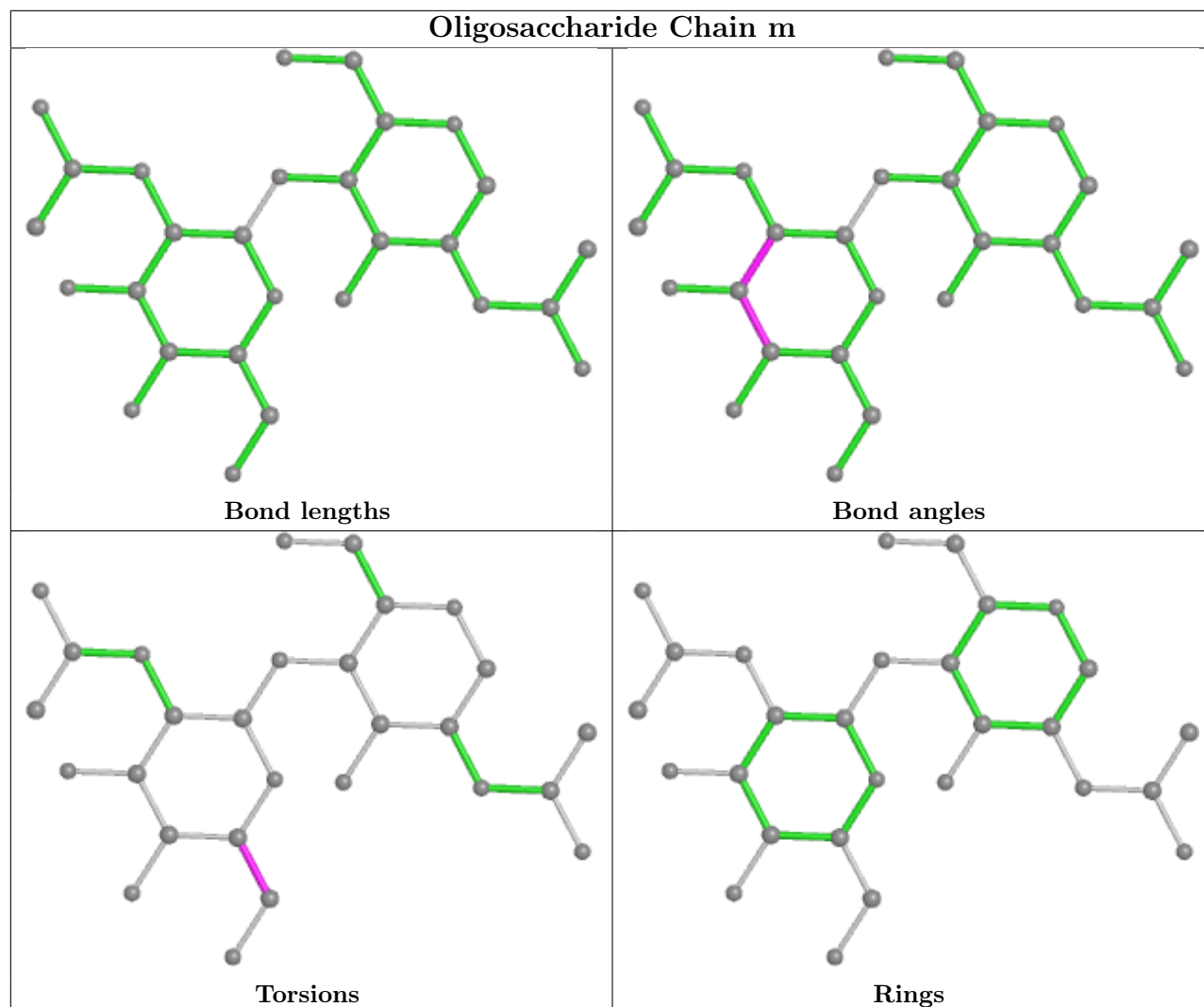

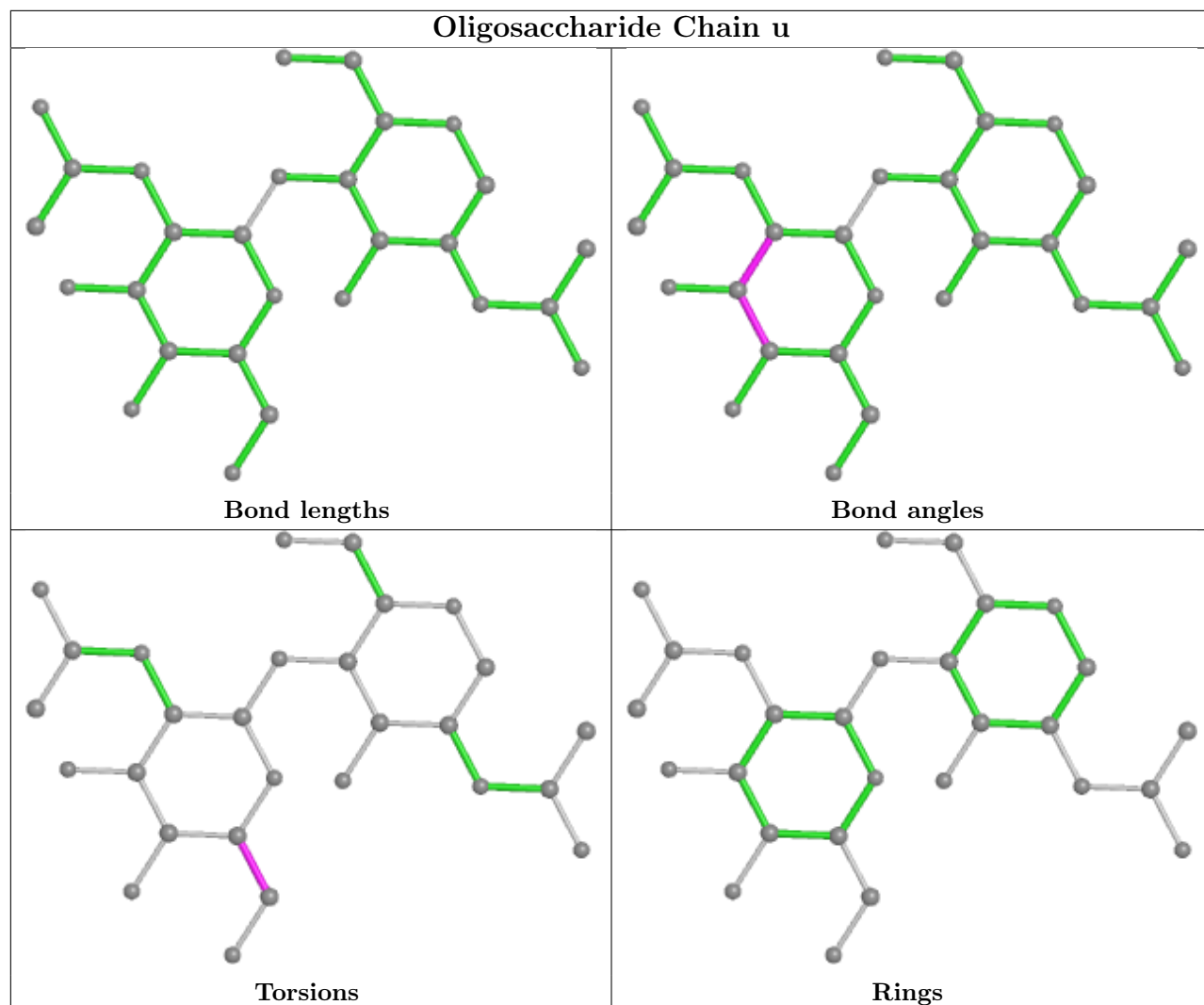

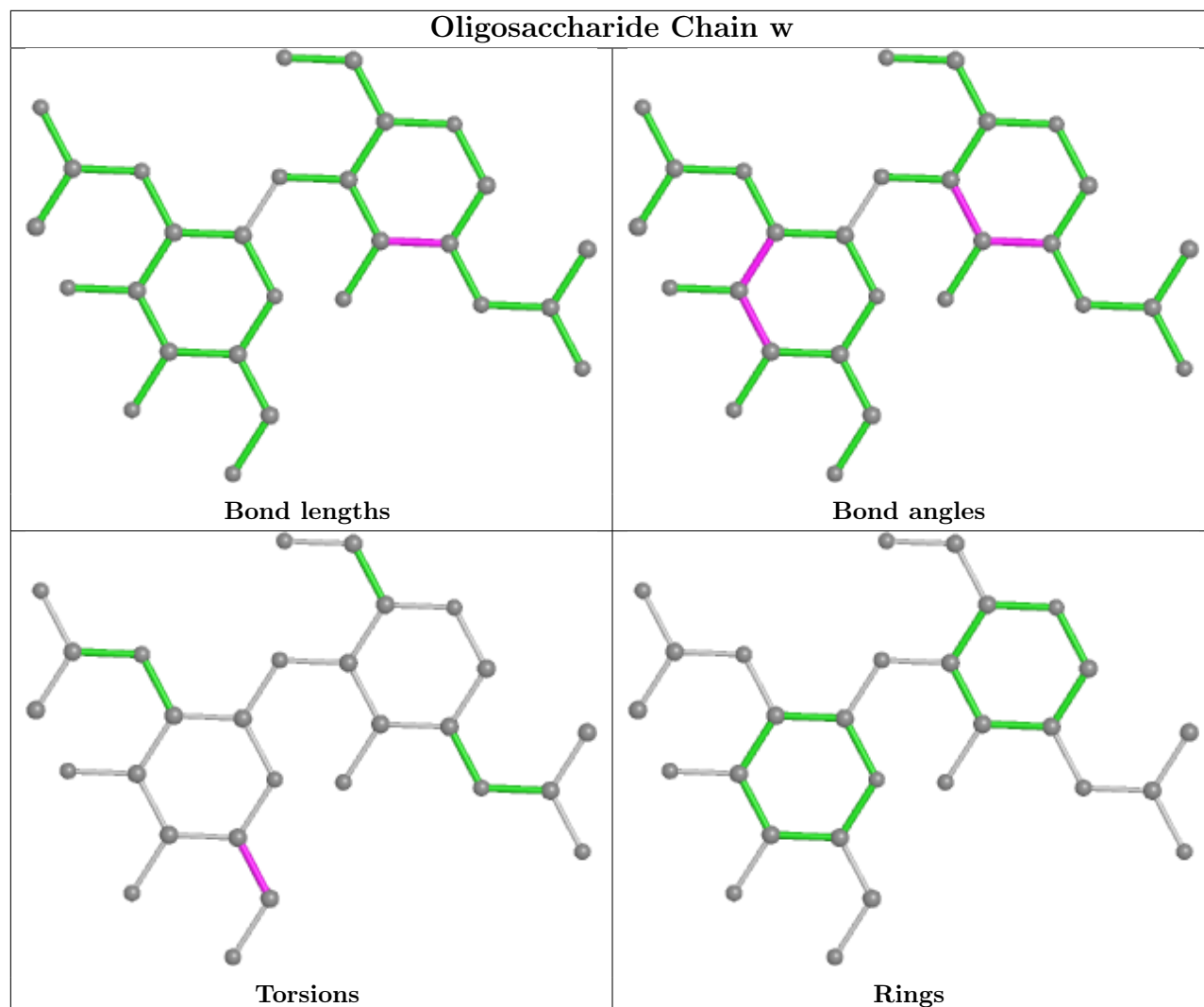

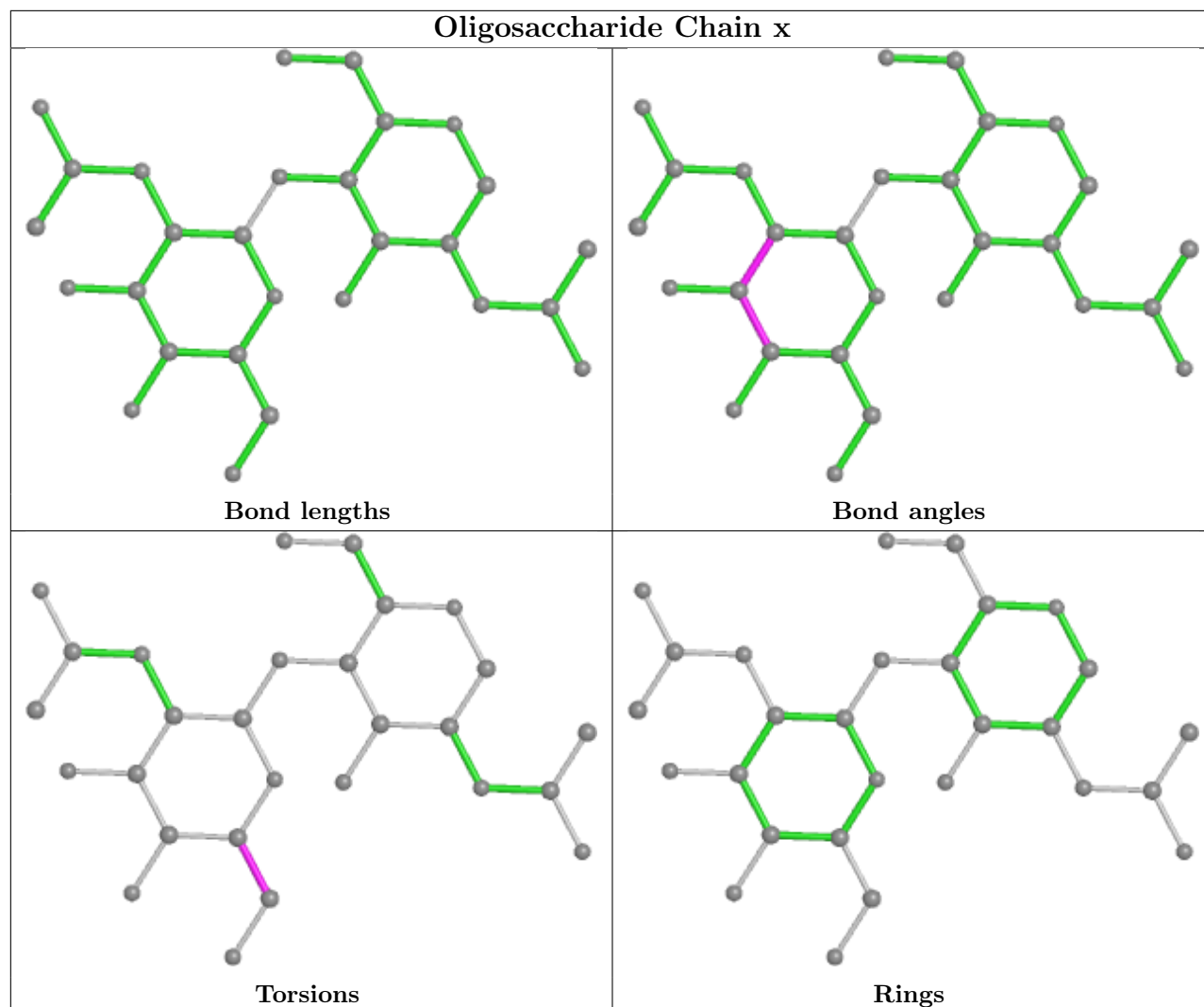

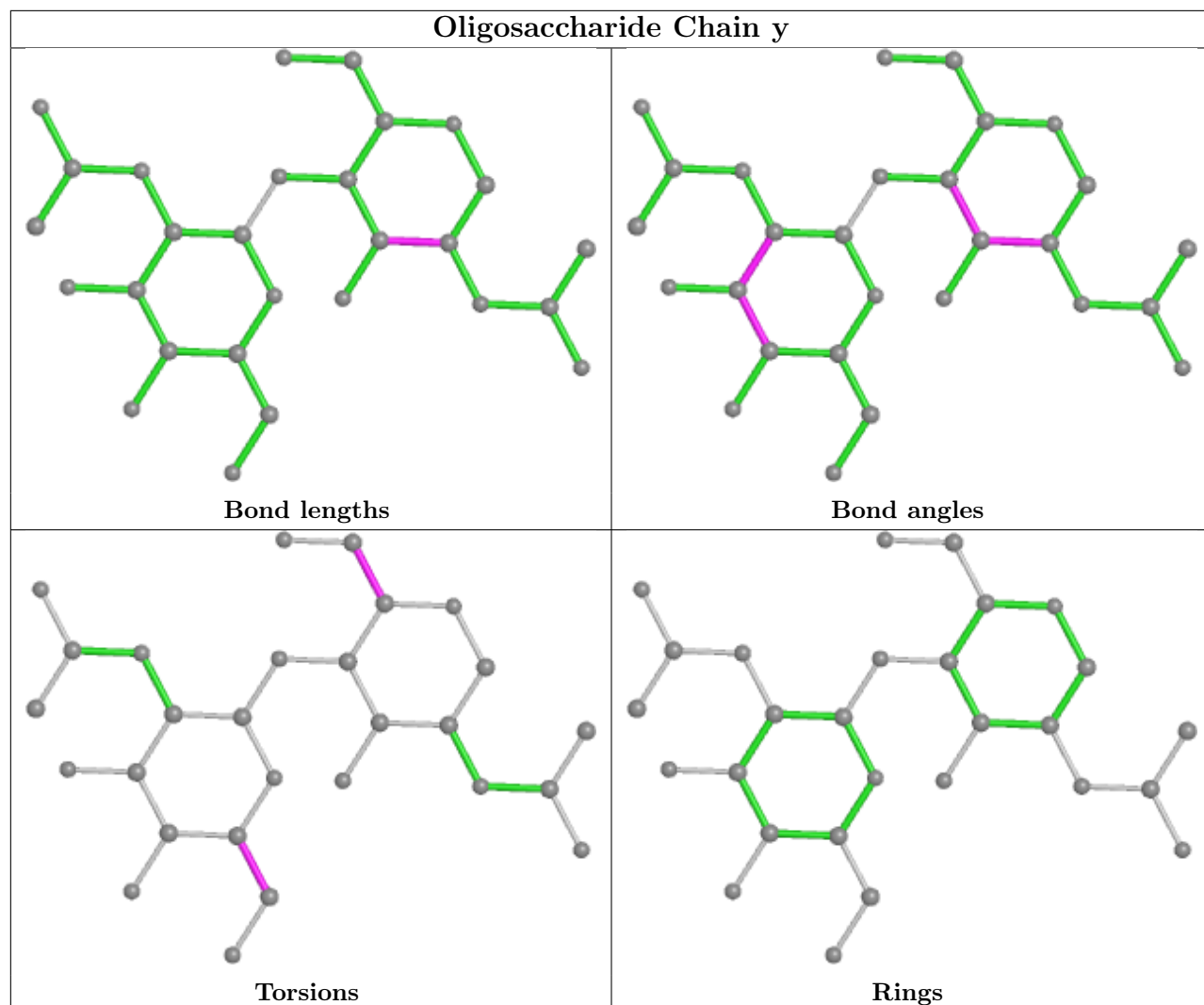

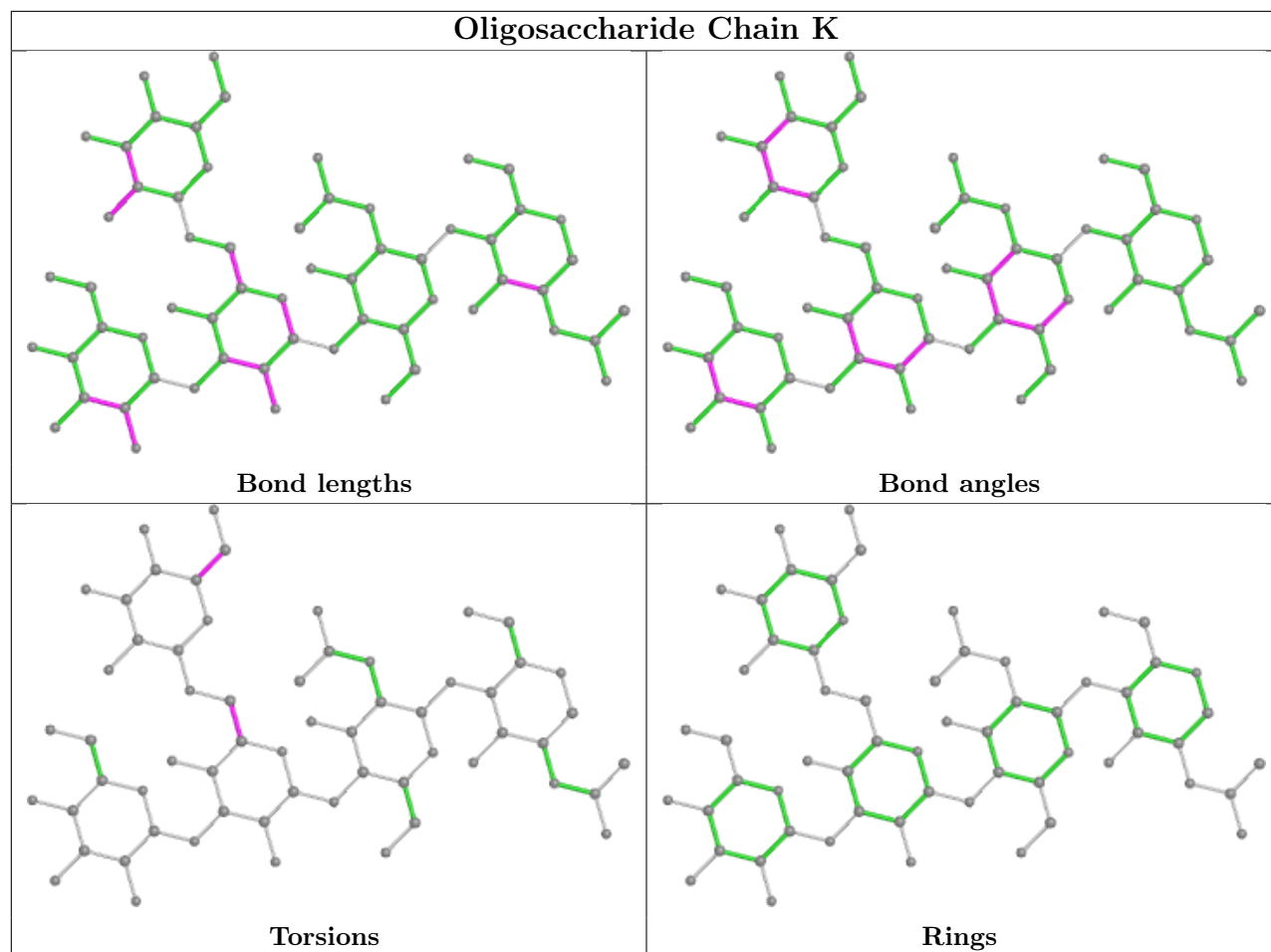

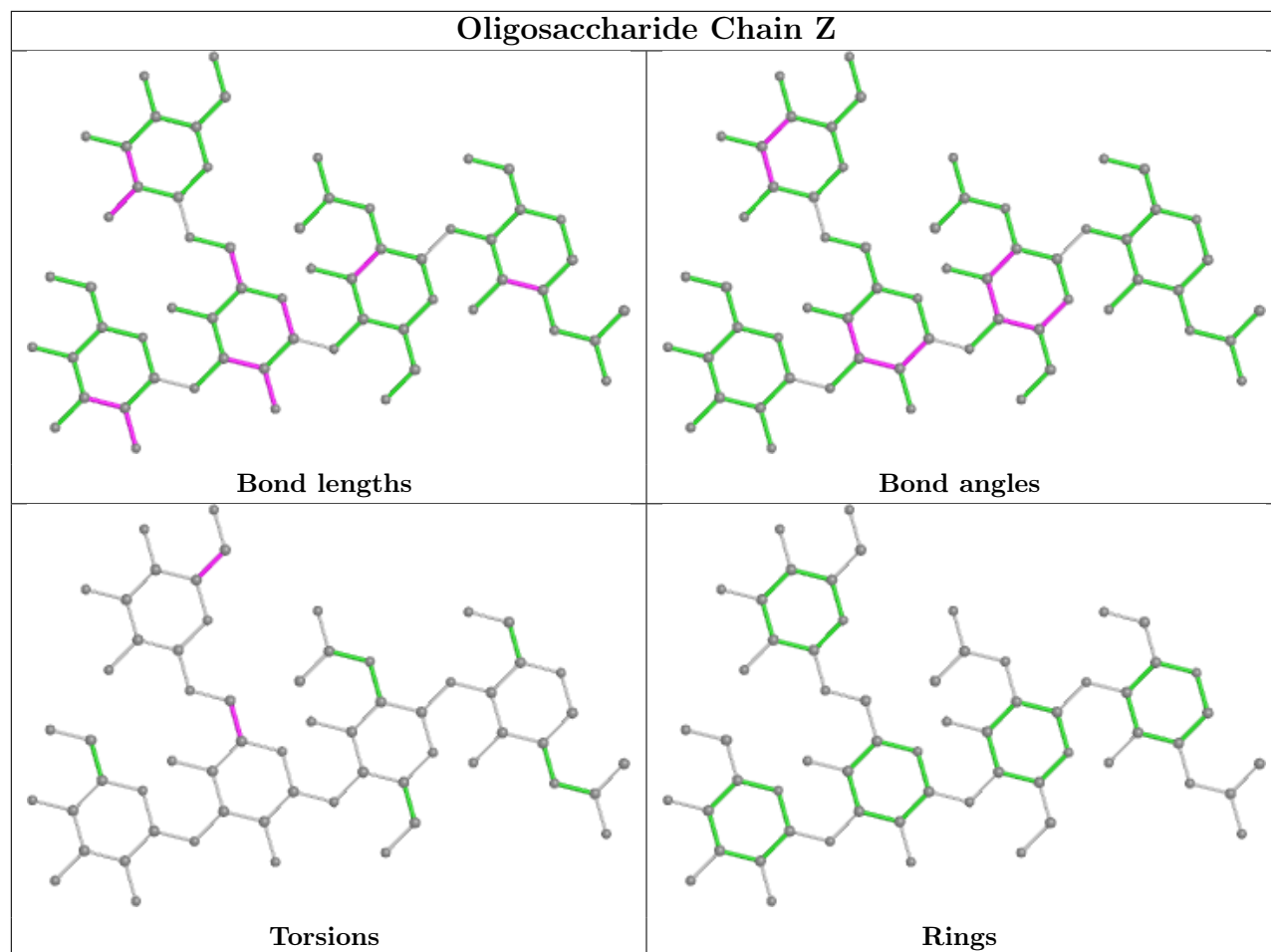

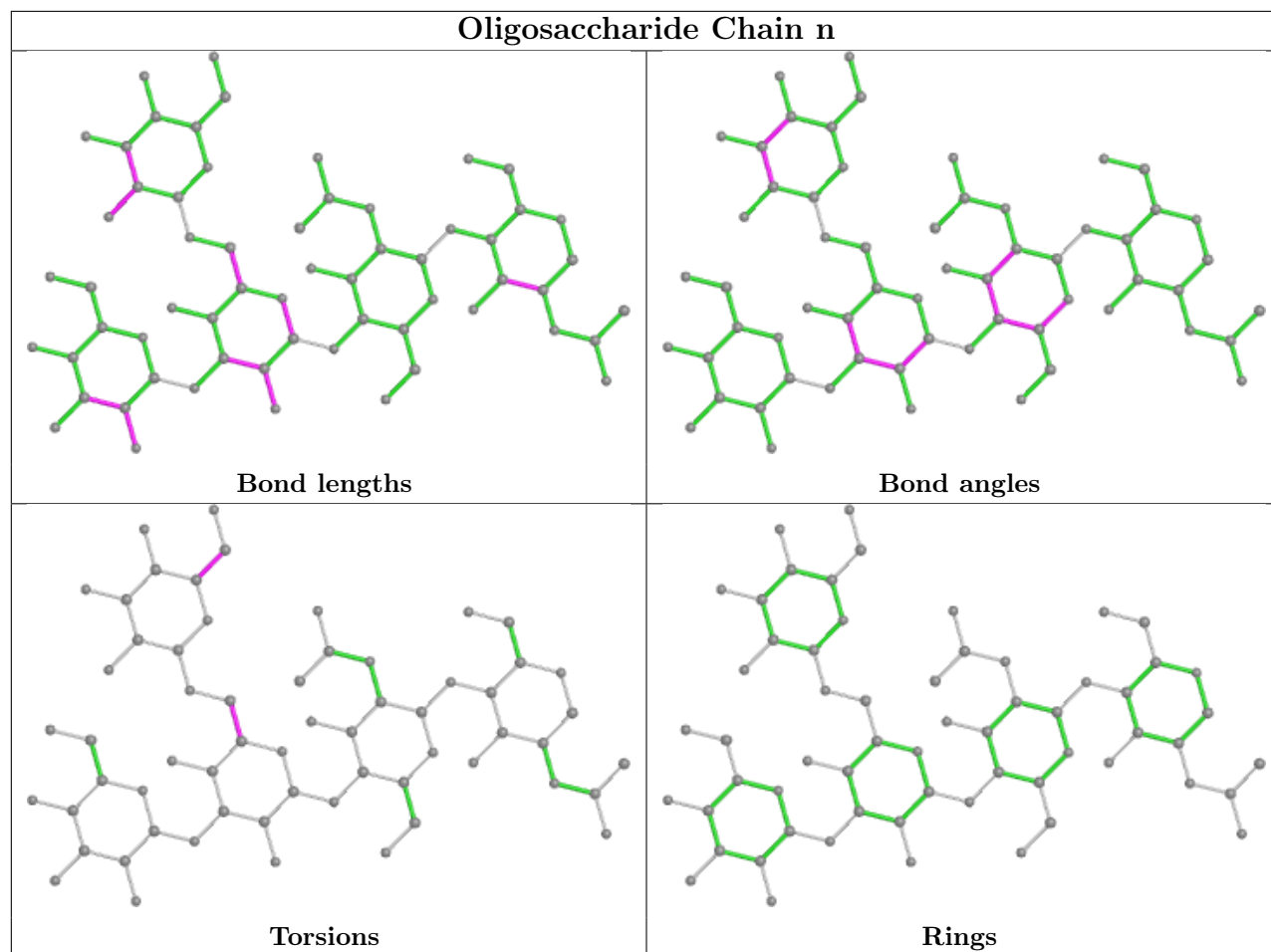

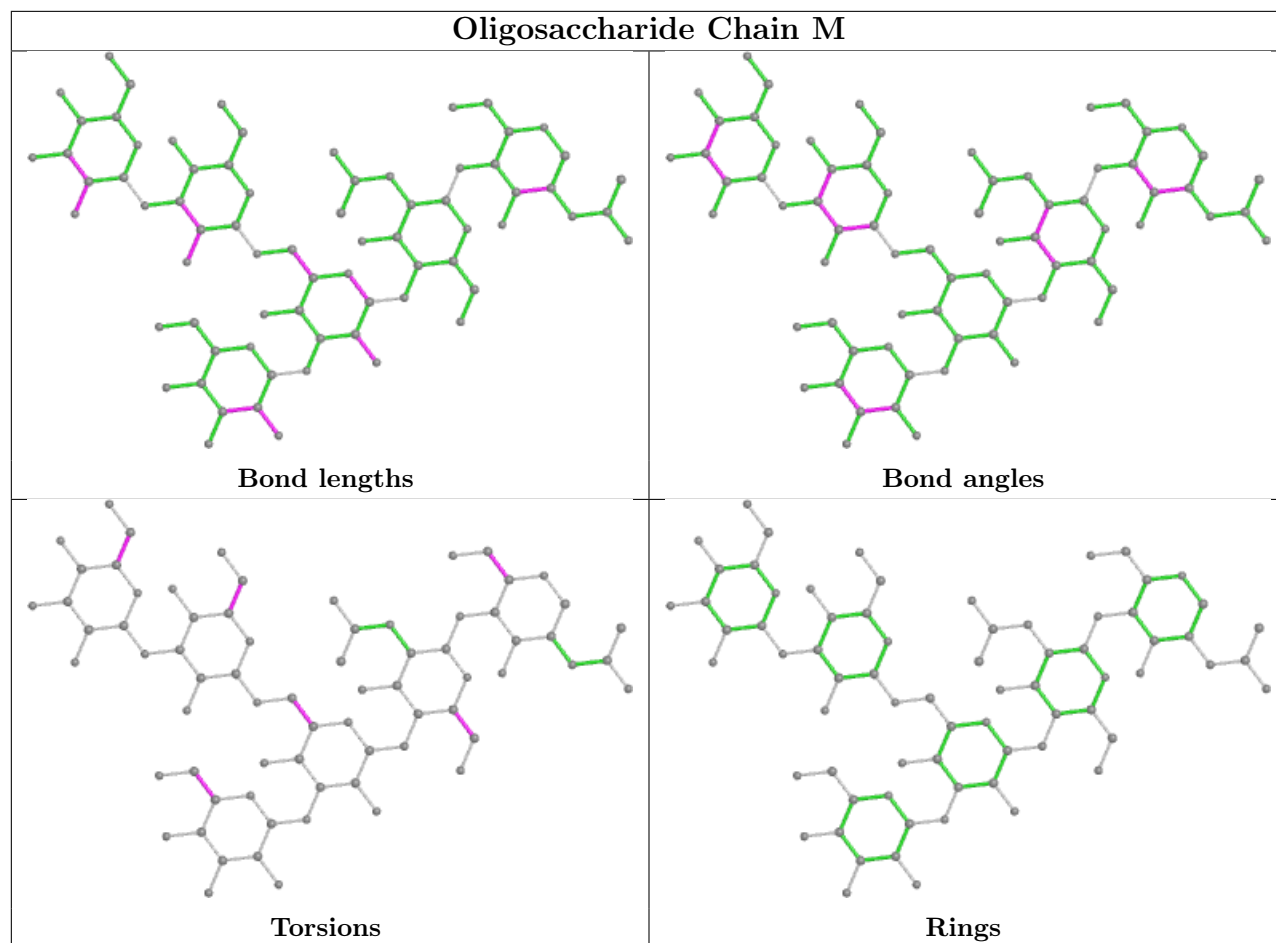

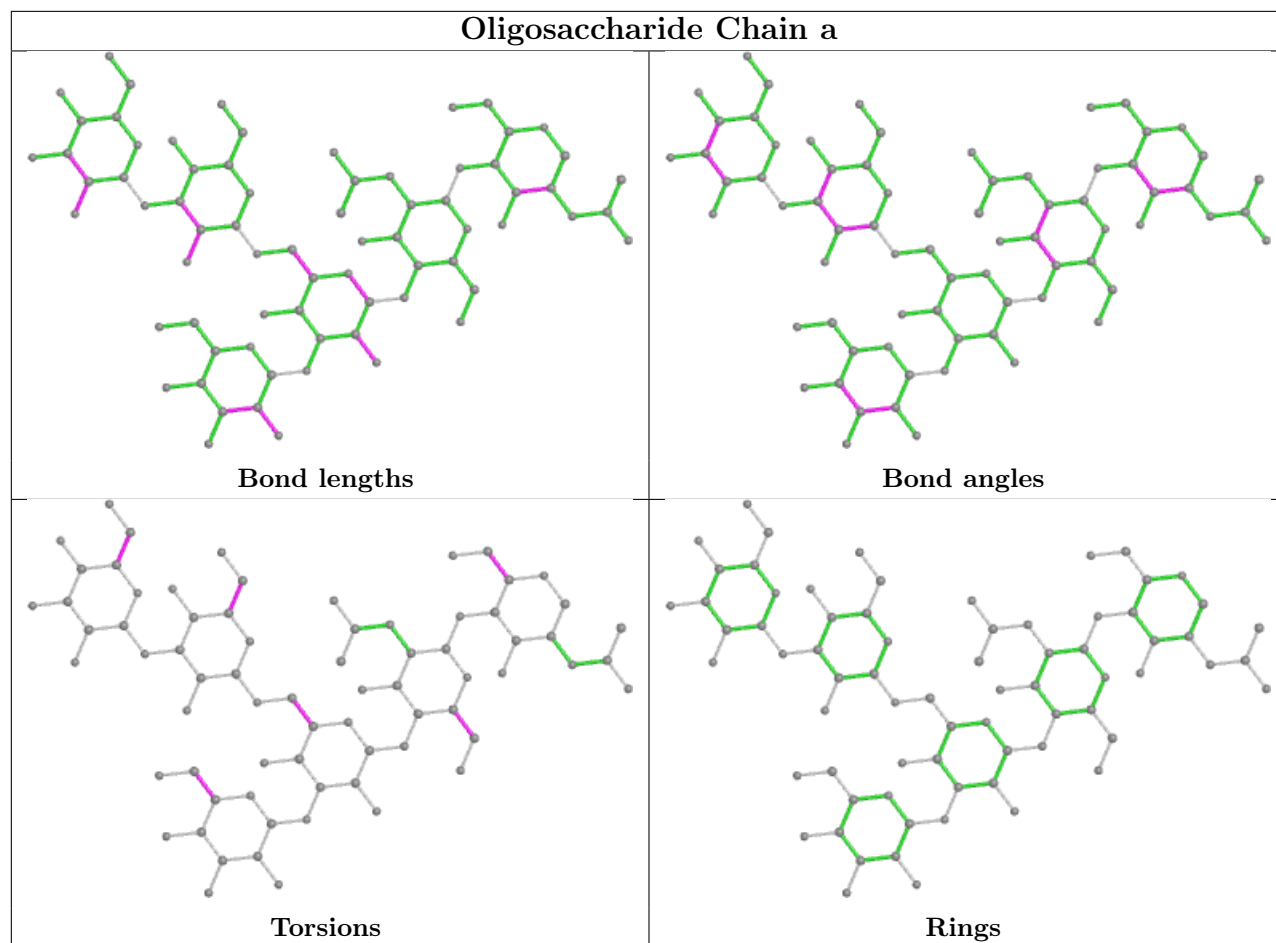

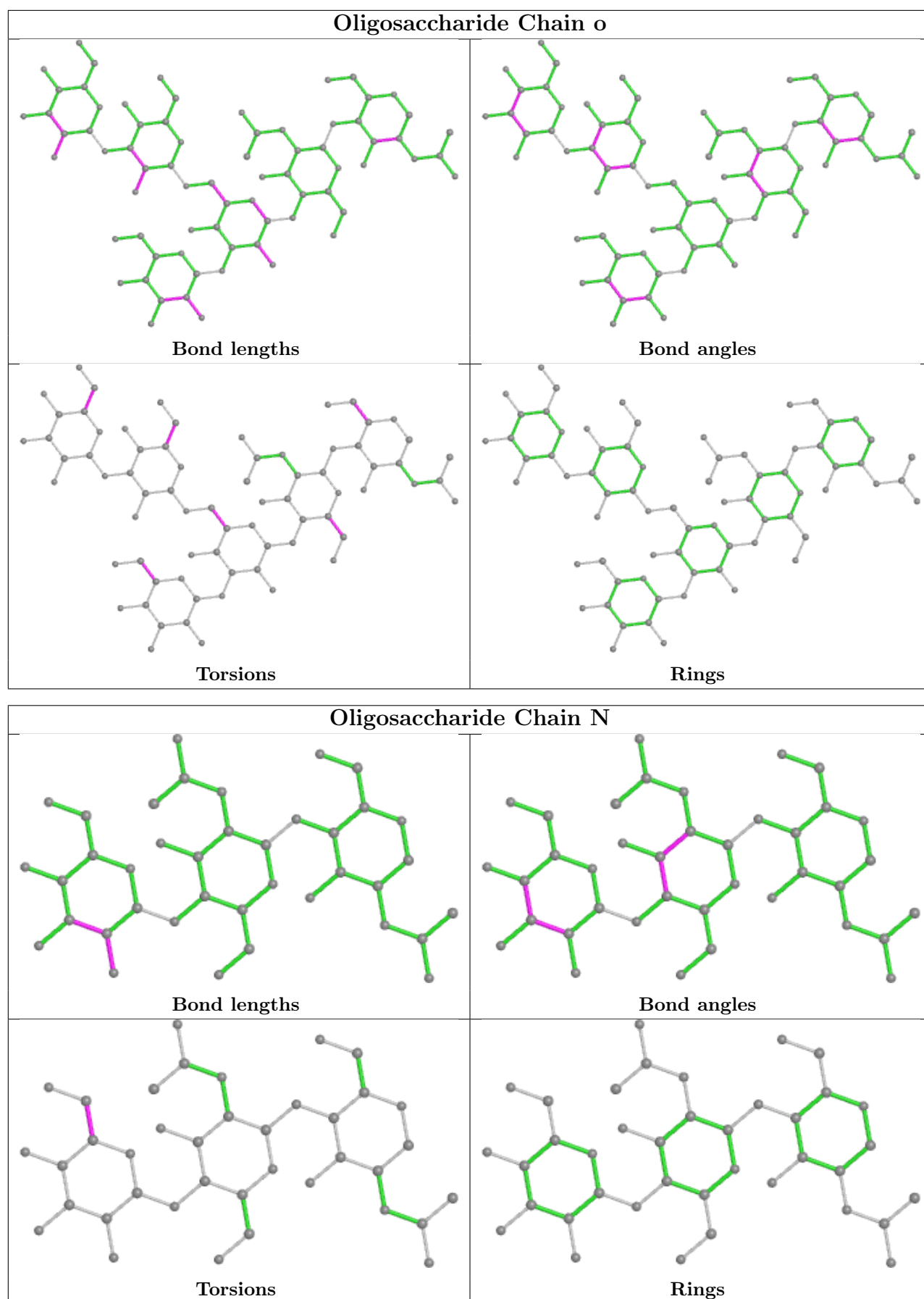

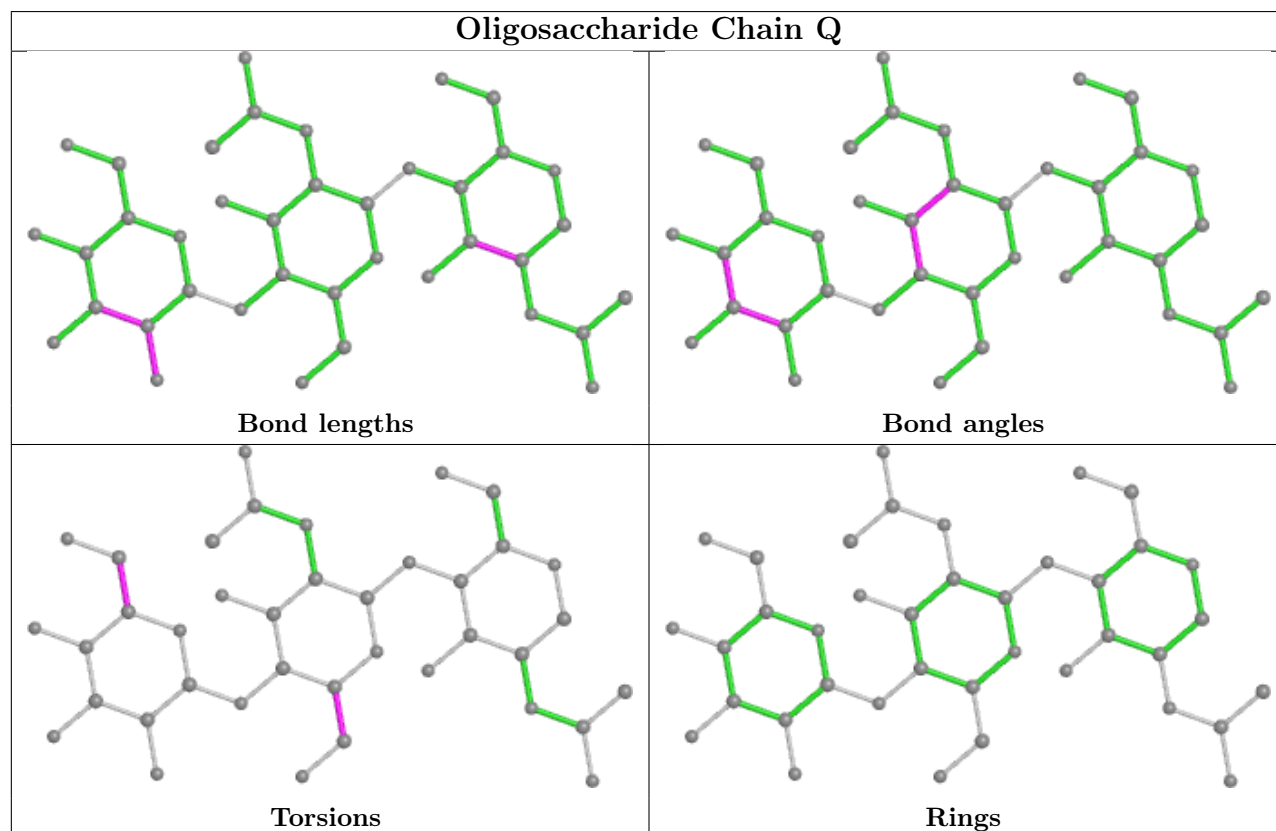
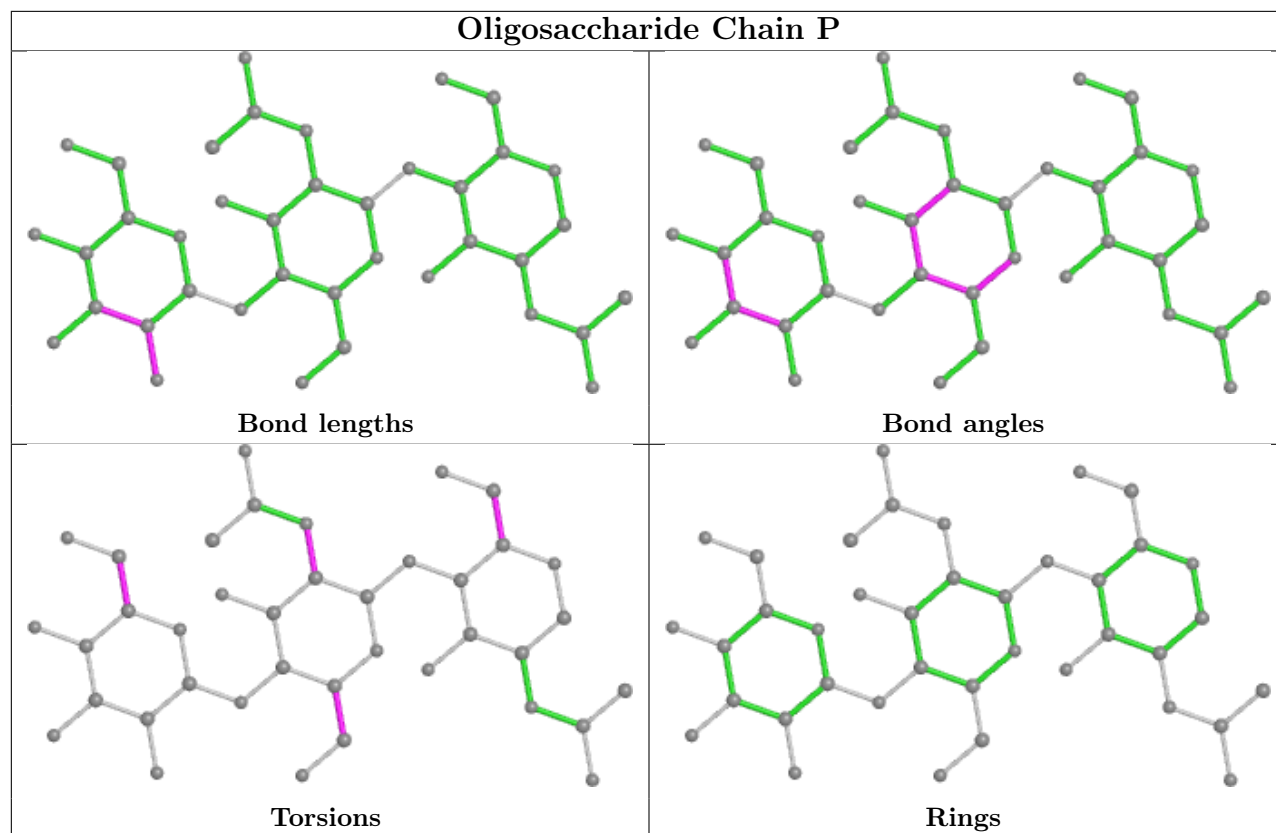

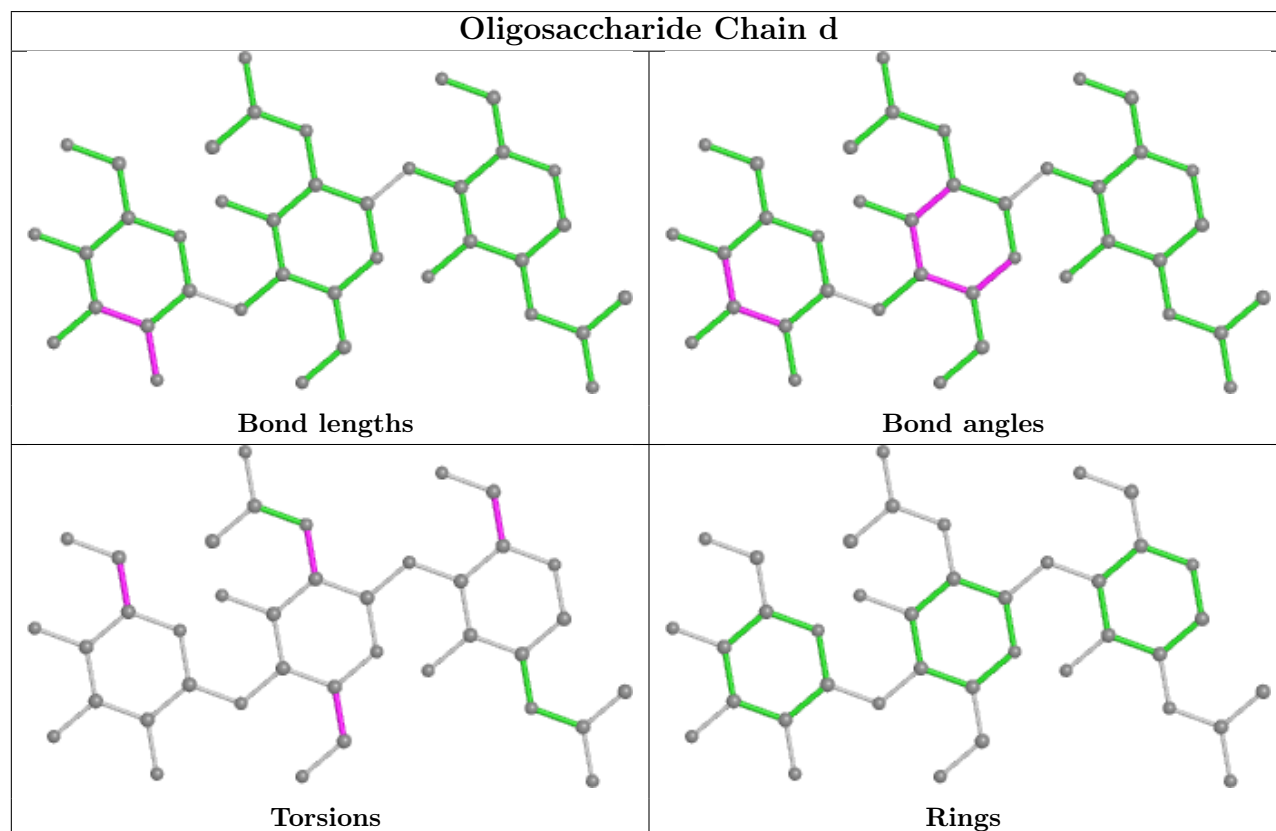
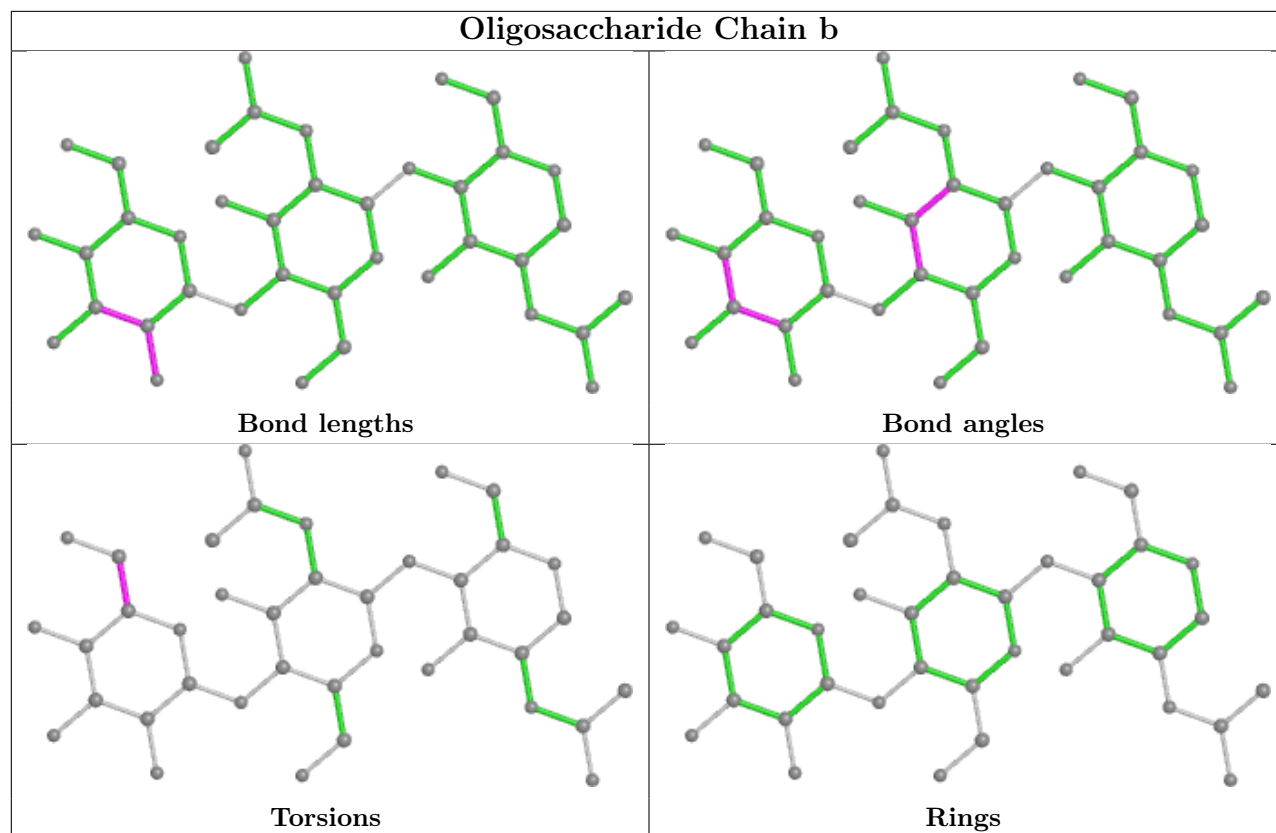

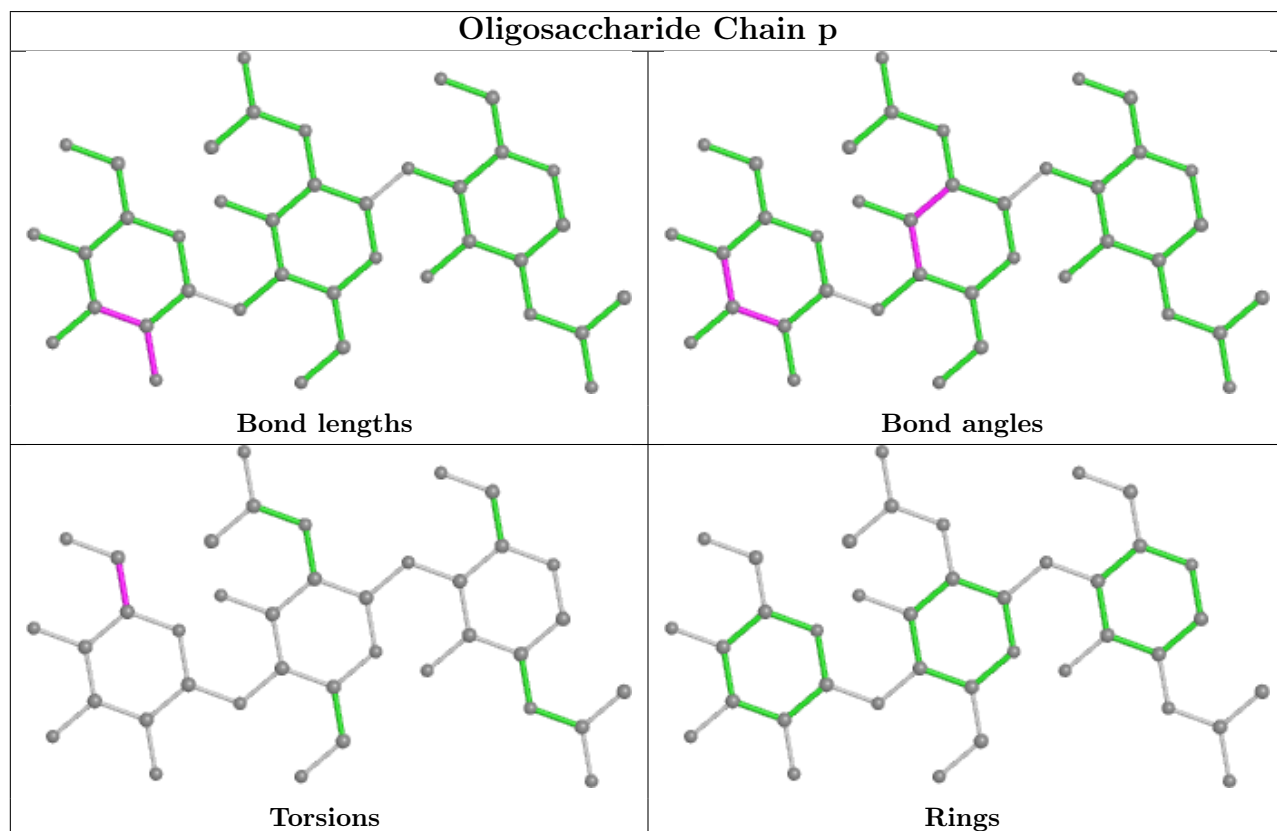
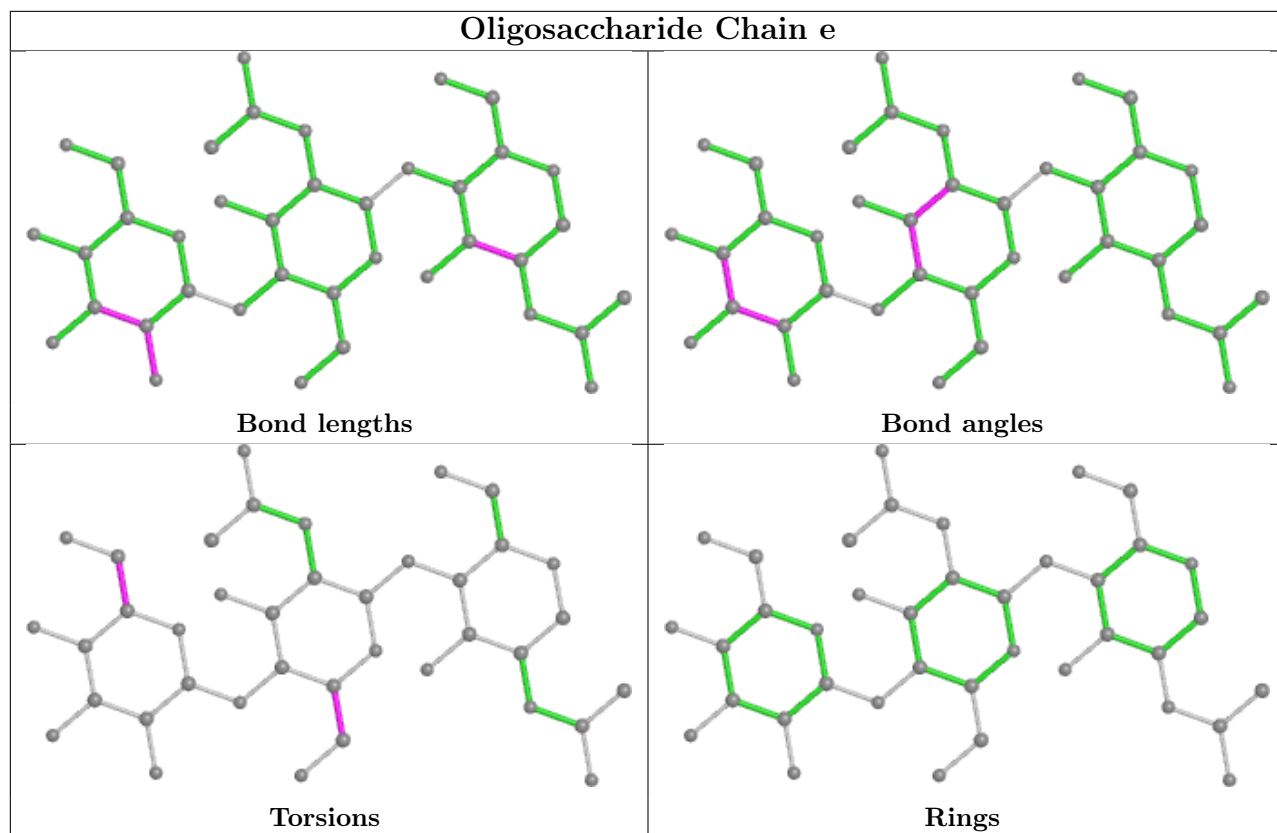

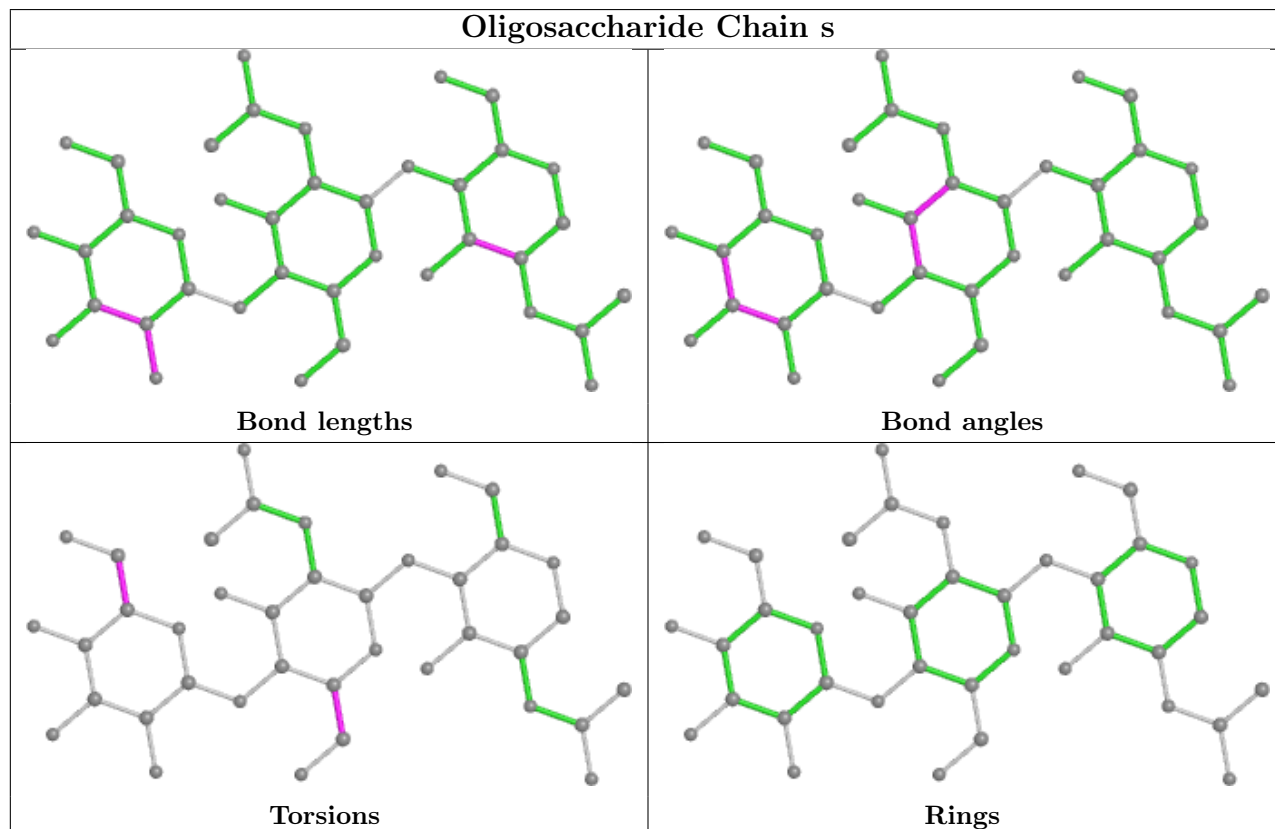
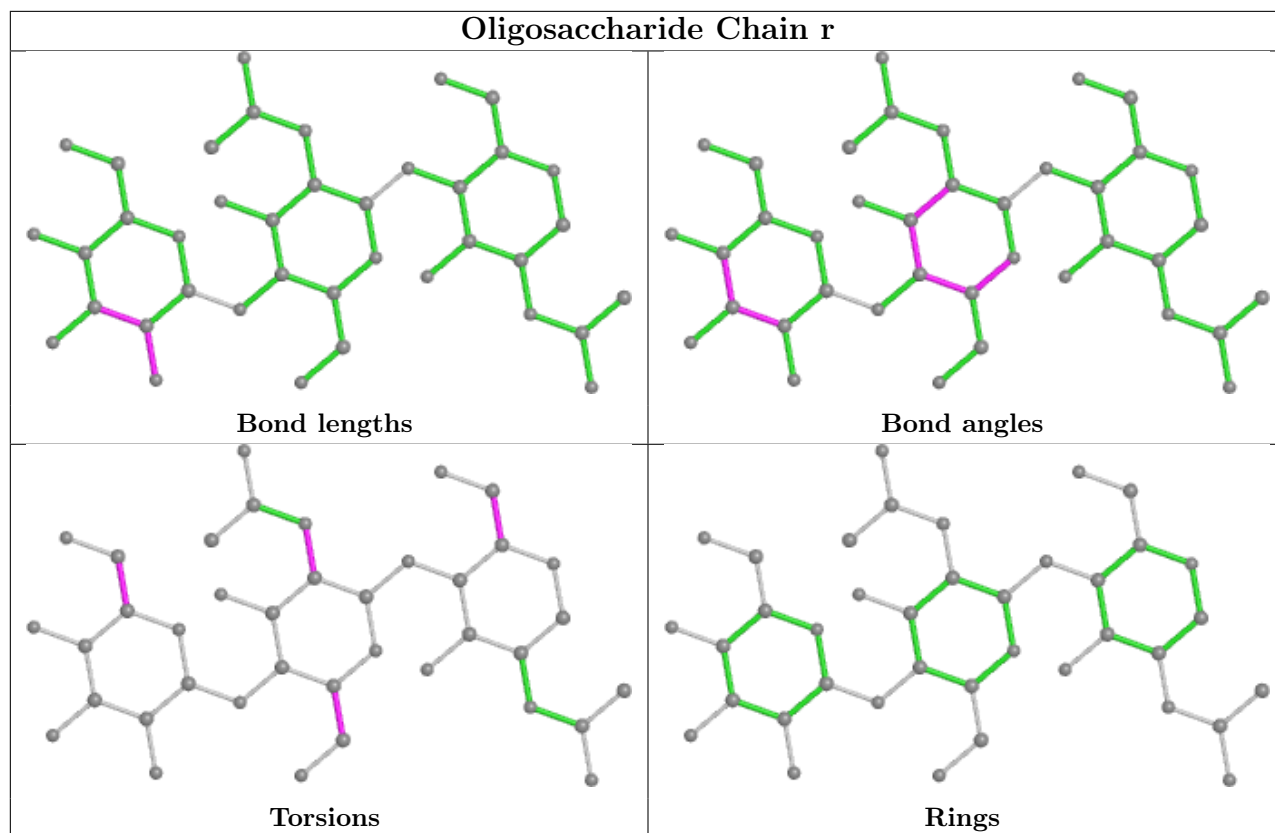

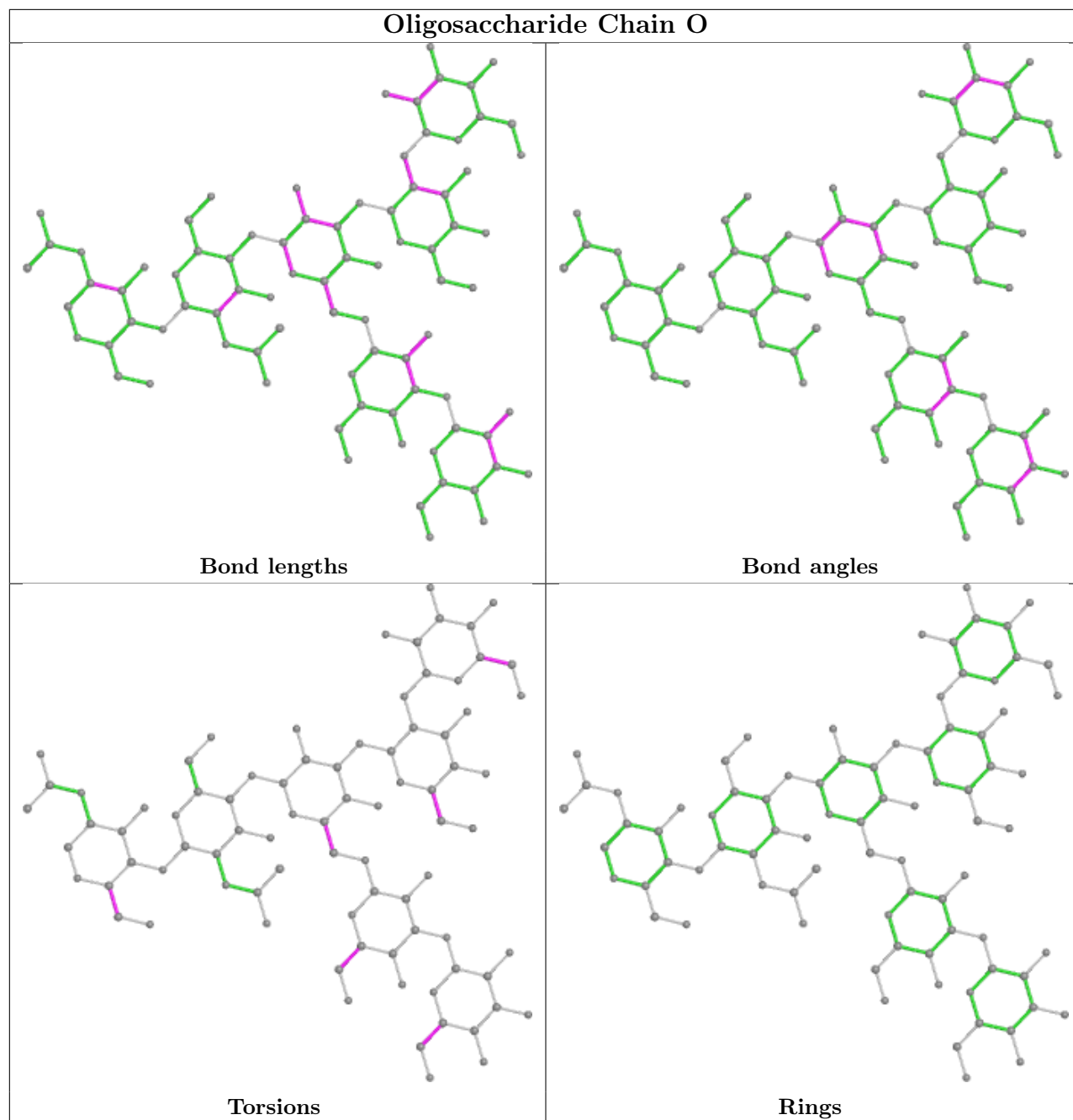

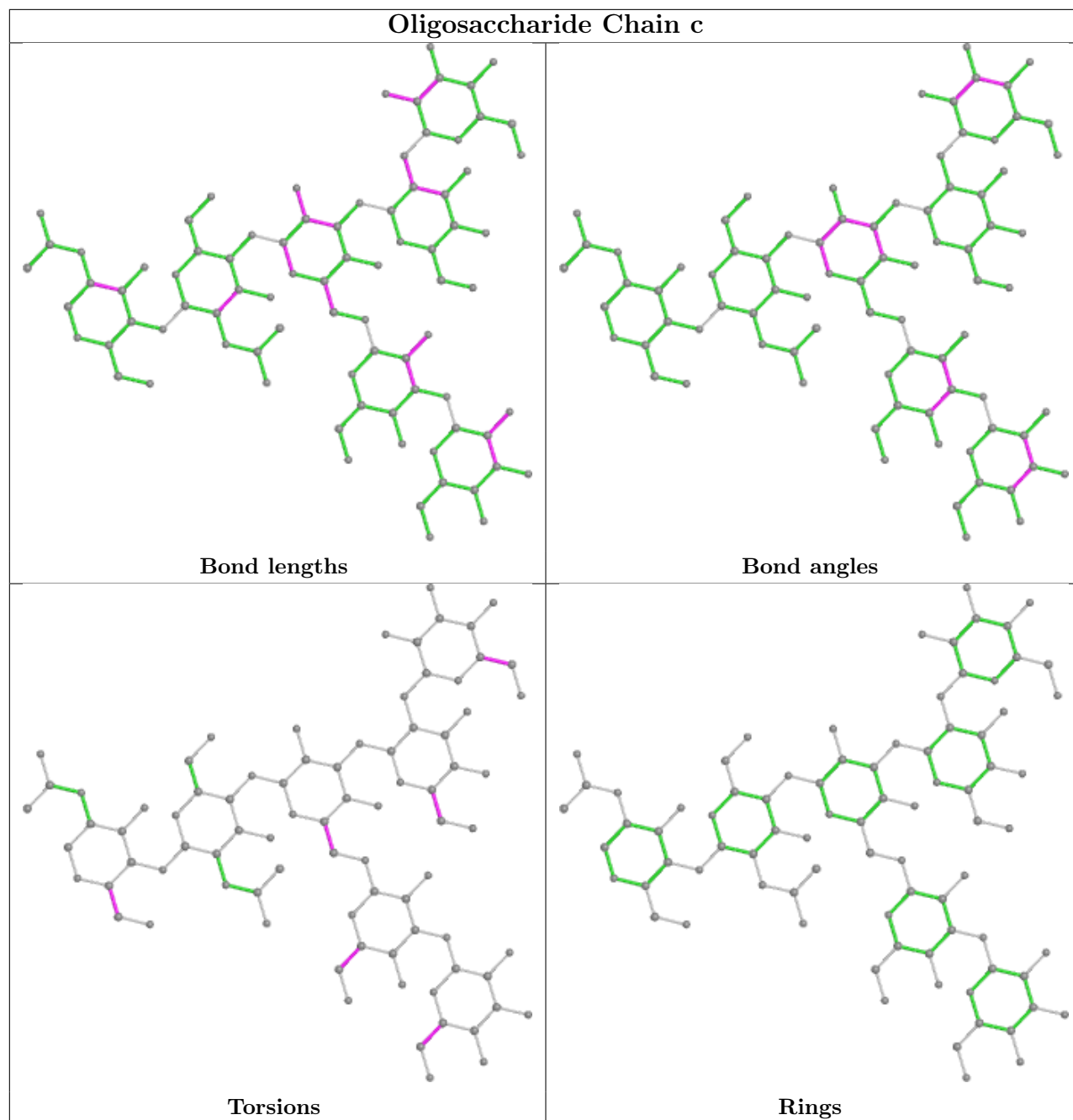

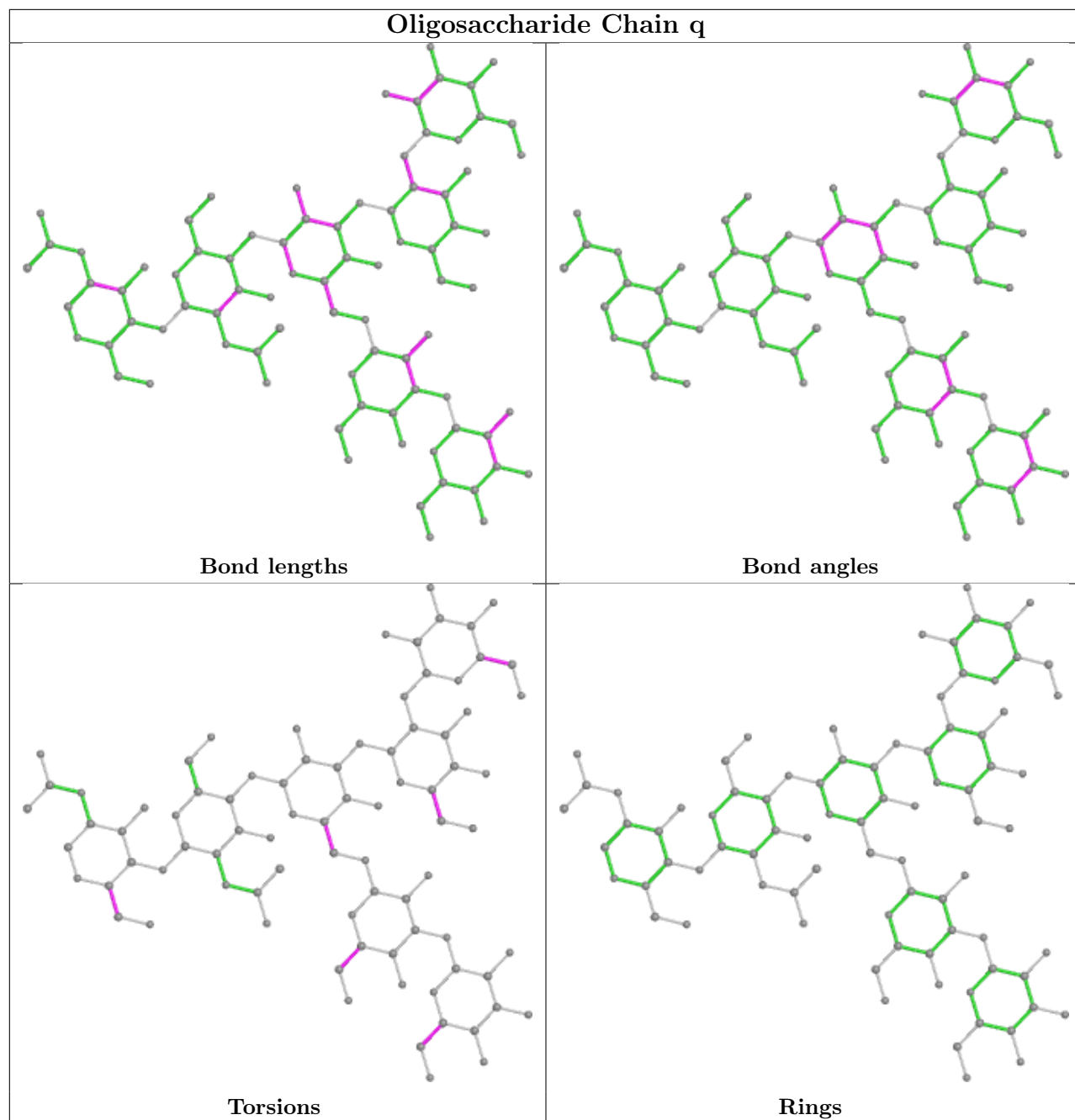

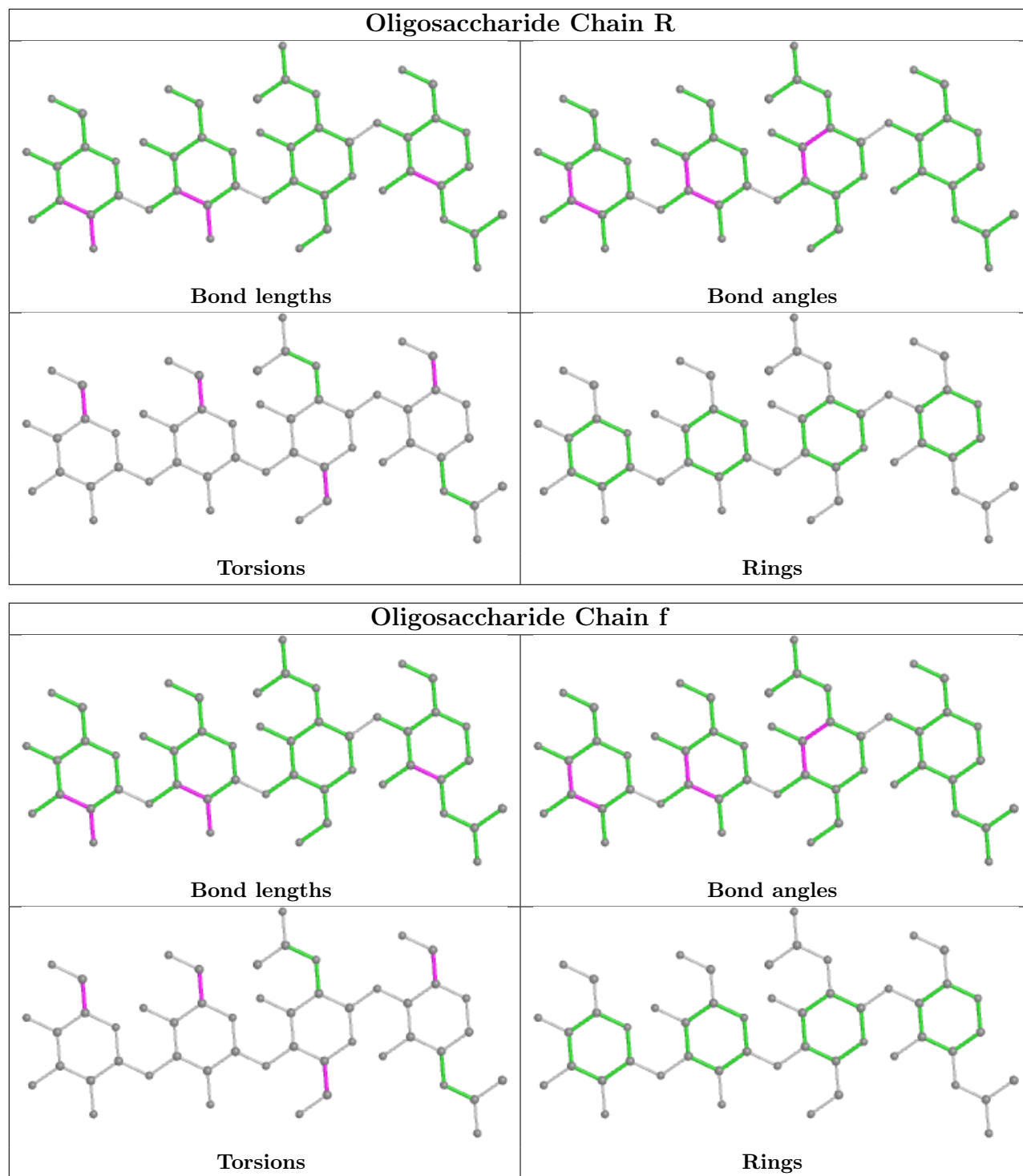

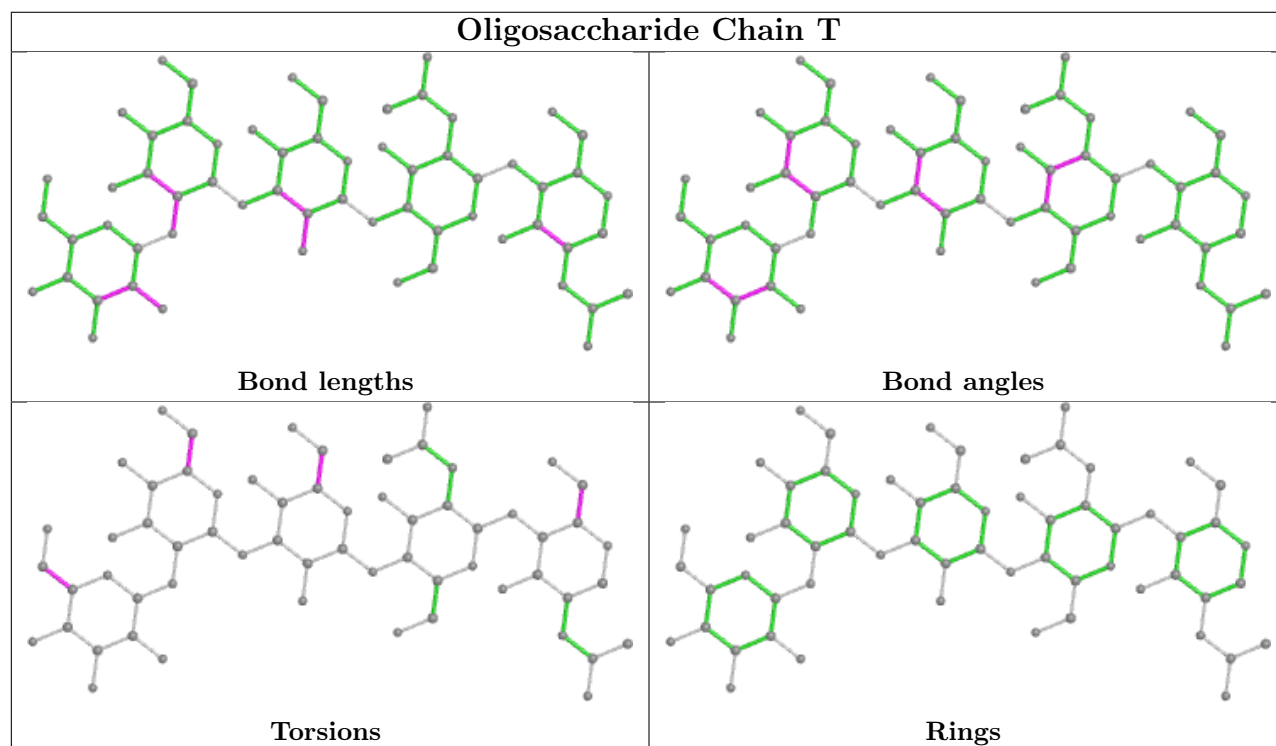
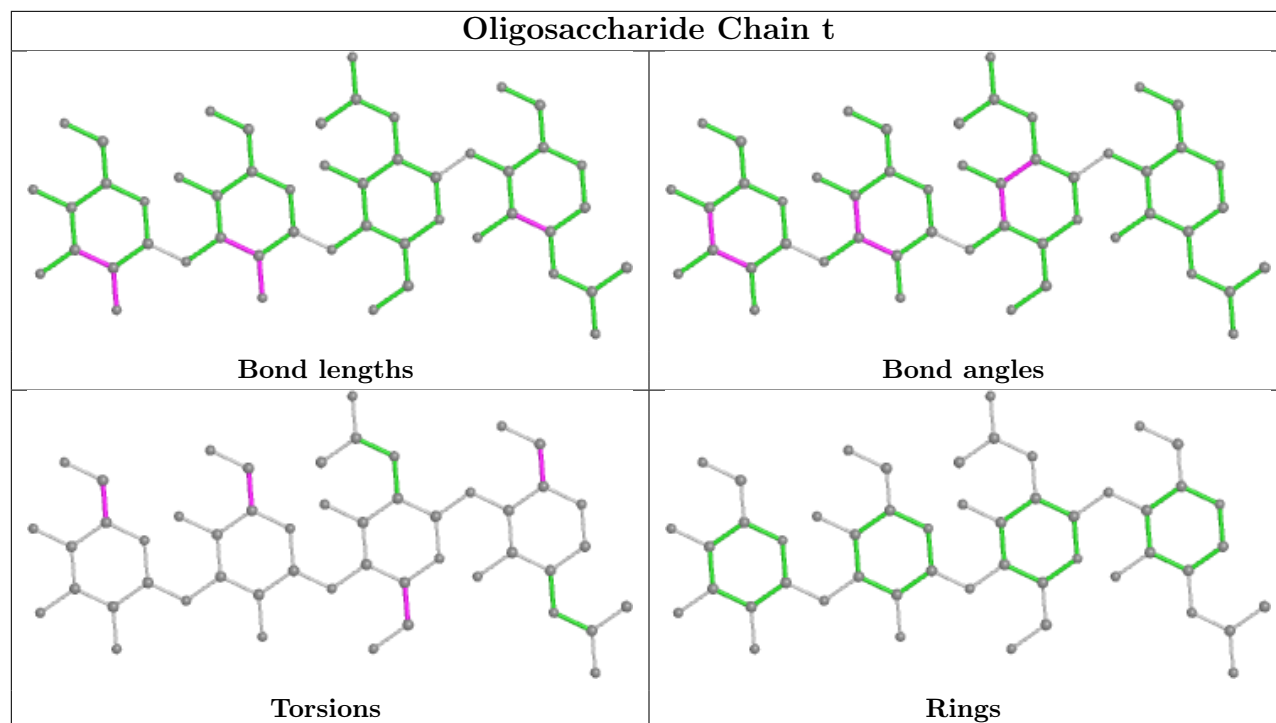

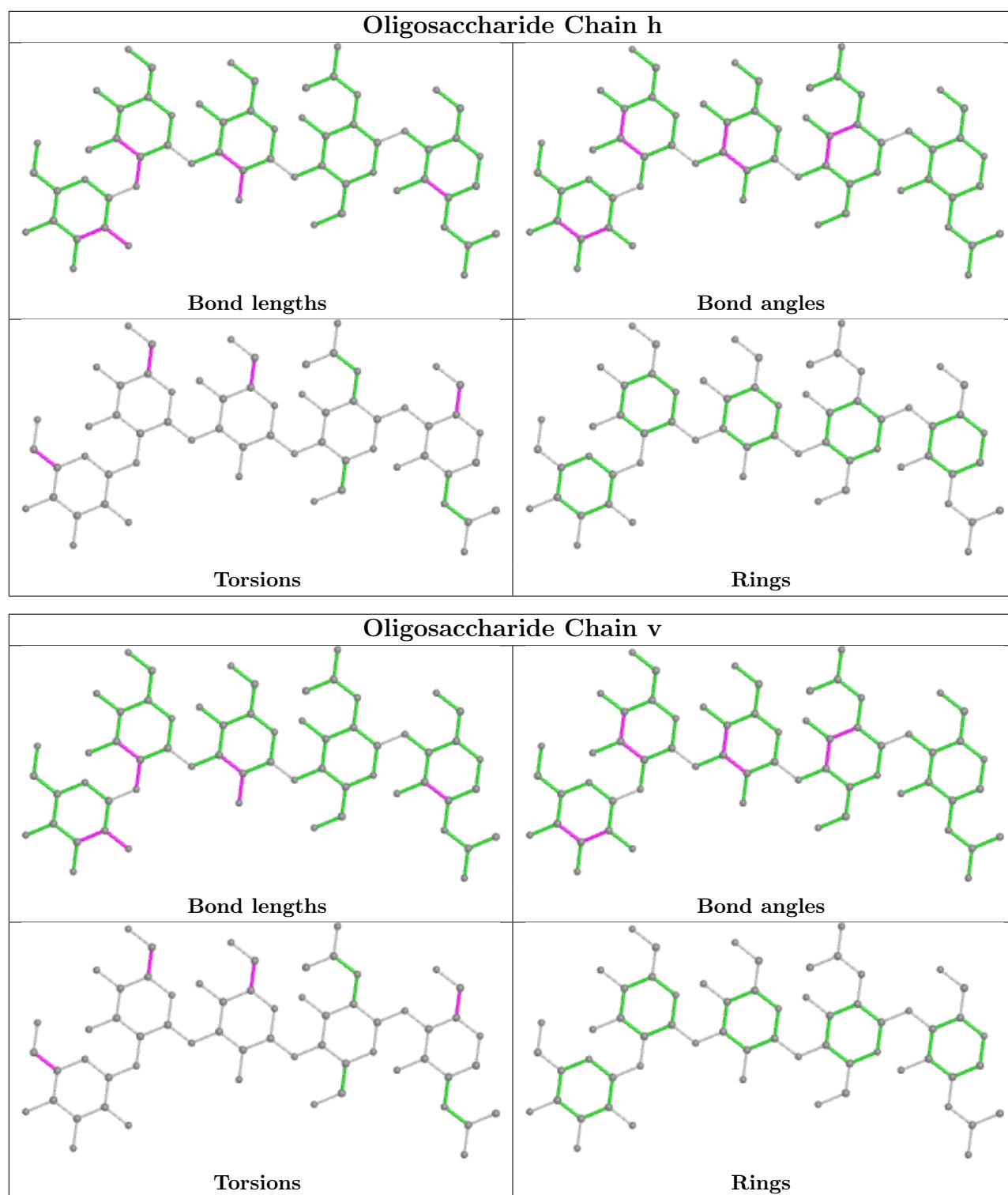

5.6 Ligand geometry [i](#)

12 ligands are modelled in this entry.

In the following table, the Counts columns list the number of bonds (or angles) for which Mogul statistics could be retrieved, the number of bonds (or angles) that are observed in the model and

the number of bonds (or angles) that are defined in the Chemical Component Dictionary. The Link column lists molecule types, if any, to which the group is linked. The Z score for a bond length (or angle) is the number of standard deviations the observed value is removed from the expected value. A bond length (or angle) with $|Z| > 2$ is considered an outlier worth inspection. RMSZ is the root-mean-square of all Z scores of the bond lengths (or angles).

Mol	Type	Chain	Res	Link	Bond lengths			Bond angles		
					Counts	RMSZ	# Z > 2	Counts	RMSZ	# Z > 2
11	NAG	A	747	1	14,14,15	0.81	0	17,19,21	0.98	1 (5%)
11	NAG	A	738	1	14,14,15	0.80	0	17,19,21	0.93	1 (5%)
11	NAG	B	748	1	14,14,15	0.80	0	17,19,21	1.06	1 (5%)
11	NAG	B	744	1	14,14,15	0.82	0	17,19,21	0.80	0
11	NAG	A	748	1	14,14,15	0.81	0	17,19,21	1.05	1 (5%)
11	NAG	B	738	1	14,14,15	0.79	0	17,19,21	0.94	1 (5%)
11	NAG	A	744	1	14,14,15	0.83	0	17,19,21	0.80	0
11	NAG	B	747	1	14,14,15	0.80	0	17,19,21	0.97	1 (5%)
11	NAG	E	747	1	14,14,15	0.81	0	17,19,21	0.98	1 (5%)
11	NAG	E	744	1	14,14,15	0.83	0	17,19,21	0.80	0
11	NAG	E	748	1	14,14,15	0.80	0	17,19,21	1.06	1 (5%)
11	NAG	E	738	1	14,14,15	0.79	0	17,19,21	0.93	1 (5%)

In the following table, the Chirals column lists the number of chiral outliers, the number of chiral centers analysed, the number of these observed in the model and the number defined in the Chemical Component Dictionary. Similar counts are reported in the Torsion and Rings columns. '-' means no outliers of that kind were identified.

Mol	Type	Chain	Res	Link	Chirals	Torsions	Rings
11	NAG	A	747	1	-	3/6/23/26	0/1/1/1
11	NAG	A	738	1	-	2/6/23/26	0/1/1/1
11	NAG	B	748	1	-	1/6/23/26	0/1/1/1
11	NAG	B	744	1	-	1/6/23/26	0/1/1/1
11	NAG	A	748	1	-	1/6/23/26	0/1/1/1
11	NAG	B	738	1	-	2/6/23/26	0/1/1/1
11	NAG	A	744	1	-	1/6/23/26	0/1/1/1
11	NAG	B	747	1	-	3/6/23/26	0/1/1/1
11	NAG	E	747	1	-	3/6/23/26	0/1/1/1
11	NAG	E	744	1	-	1/6/23/26	0/1/1/1
11	NAG	E	748	1	-	1/6/23/26	0/1/1/1
11	NAG	E	738	1	-	2/6/23/26	0/1/1/1

There are no bond length outliers.

The worst 5 of 9 bond angle outliers are listed below:

Mol	Chain	Res	Type	Atoms	Z	Observed(°)	Ideal(°)
11	B	748	NAG	C4-C3-C2	-3.12	106.45	111.02
11	E	748	NAG	C4-C3-C2	-3.11	106.46	111.02
11	A	748	NAG	C4-C3-C2	-3.09	106.49	111.02
11	A	747	NAG	C4-C3-C2	-2.94	106.70	111.02
11	E	747	NAG	C4-C3-C2	-2.93	106.72	111.02

There are no chirality outliers.

5 of 21 torsion outliers are listed below:

Mol	Chain	Res	Type	Atoms
11	A	747	NAG	O5-C5-C6-O6
11	B	747	NAG	O5-C5-C6-O6
11	E	747	NAG	O5-C5-C6-O6
11	A	738	NAG	O5-C5-C6-O6
11	E	738	NAG	O5-C5-C6-O6

There are no ring outliers.

No monomer is involved in short contacts.

5.7 Other polymers [i](#)

There are no such residues in this entry.

5.8 Polymer linkage issues [i](#)

There are no chain breaks in this entry.

6 Map visualisation [i](#)

This section contains visualisations of the EMDB entry EMD-9294. These allow visual inspection of the internal detail of the map and identification of artifacts.

No raw map or half-maps were deposited for this entry and therefore no images, graphs, etc. pertaining to the raw map can be shown.

6.1 Orthogonal projections [i](#)

6.1.1 Primary map

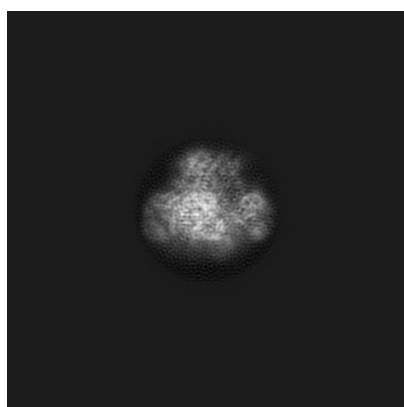

X

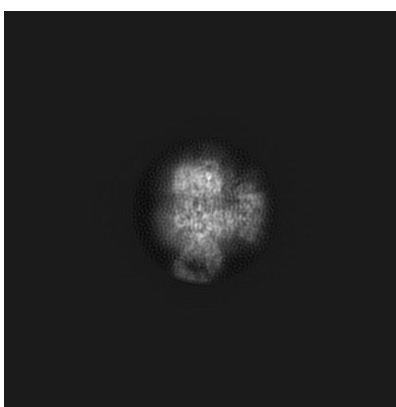

Y

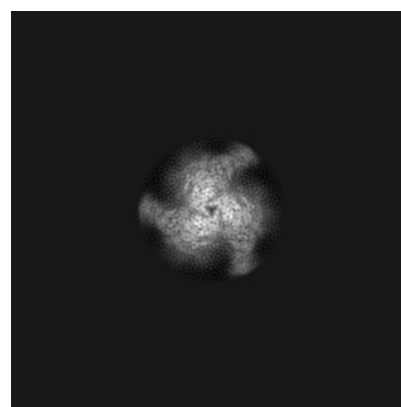

Z

The images above show the map projected in three orthogonal directions.

6.2 Central slices [i](#)

6.2.1 Primary map

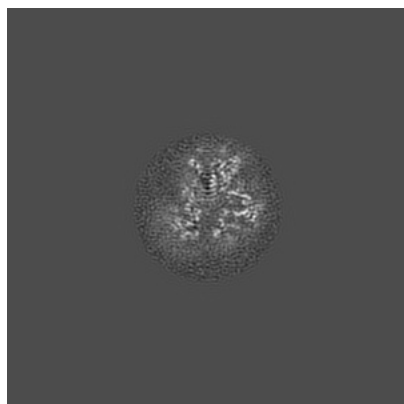

X Index: 160

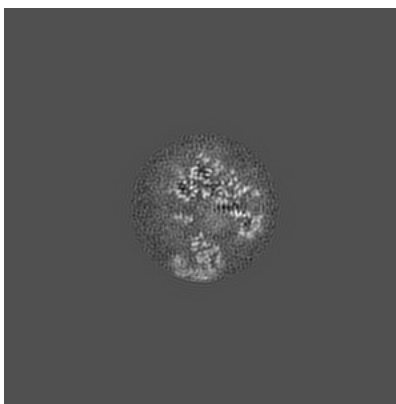

Y Index: 160

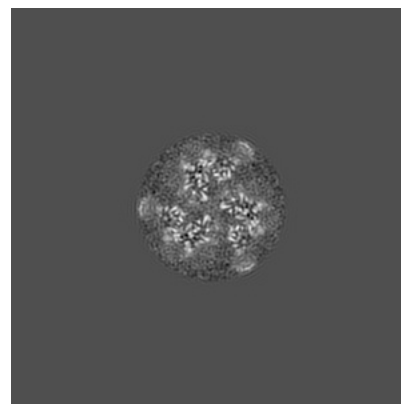

Z Index: 160

The images above show central slices of the map in three orthogonal directions.

6.3 Largest variance slices [i](#)

6.3.1 Primary map

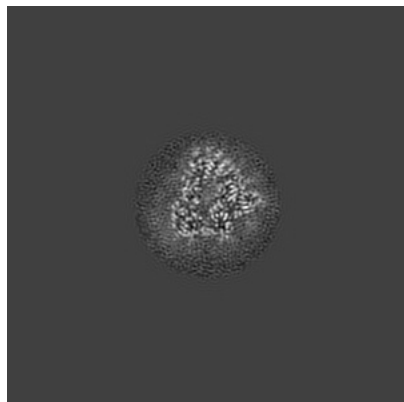

X Index: 153

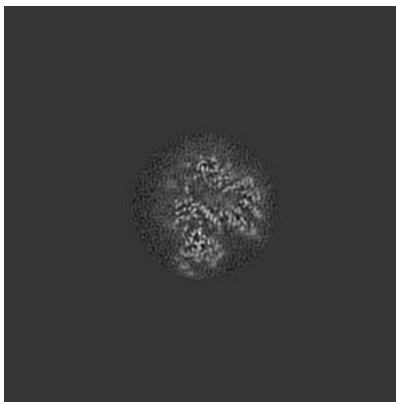

Y Index: 151

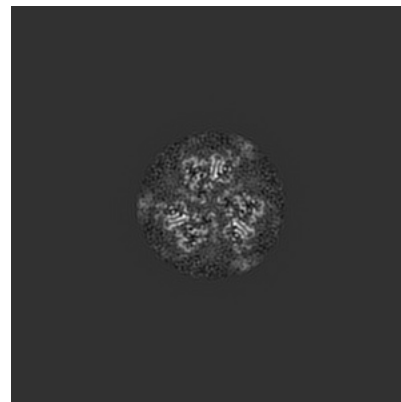

Z Index: 156

The images above show the largest variance slices of the map in three orthogonal directions.

6.4 Orthogonal surface views [i](#)

6.4.1 Primary map



X



Y



Z

The images above show the 3D surface view of the map at the recommended contour level 0.08. These images, in conjunction with the slice images, may facilitate assessment of whether an appropriate contour level has been provided.

6.5 Mask visualisation

This section was not generated. No masks/segmentation were deposited.

7 Map analysis [i](#)

This section contains the results of statistical analysis of the map.

7.1 Map-value distribution [i](#)

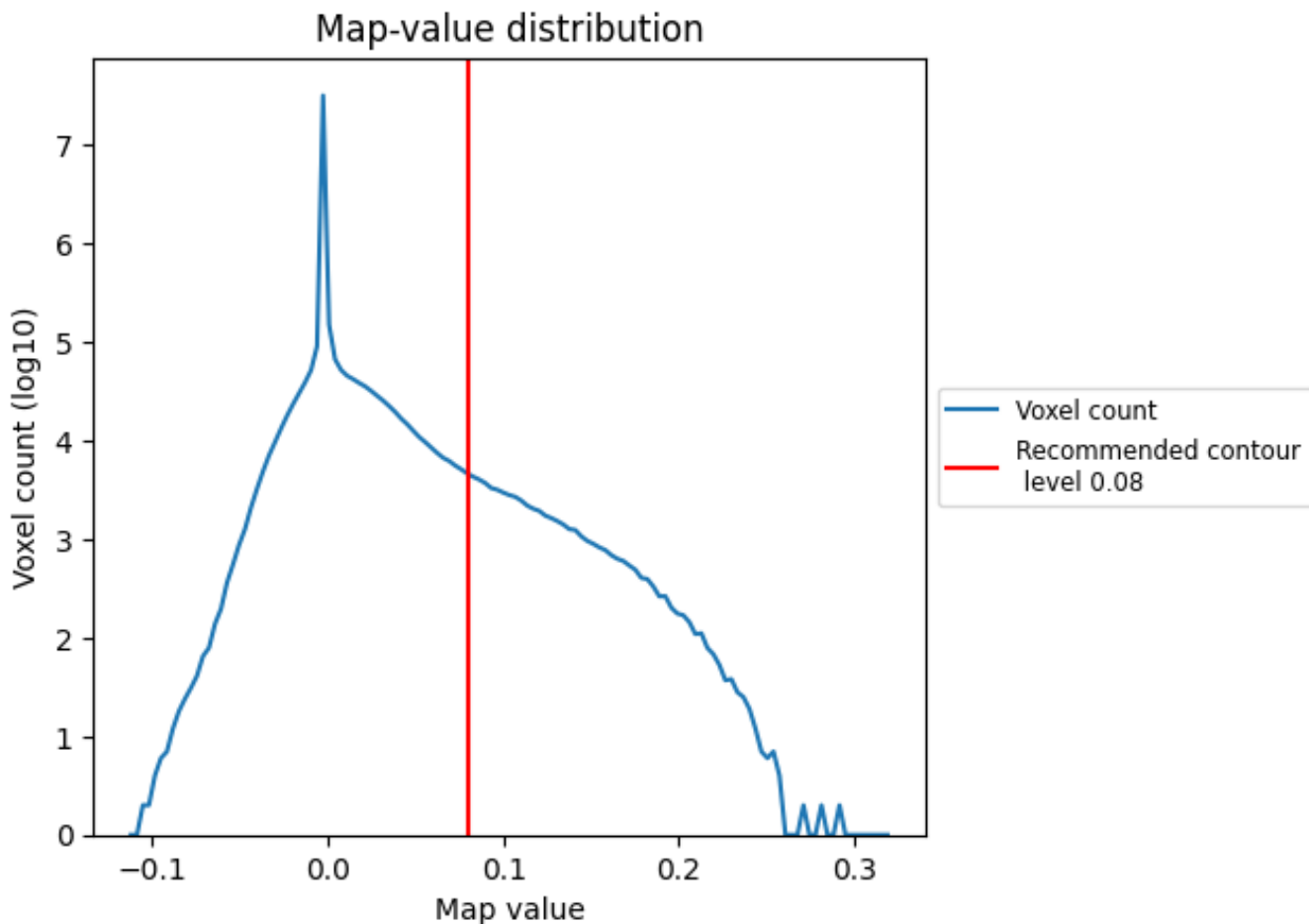

The map-value distribution is plotted in 128 intervals along the x-axis. The y-axis is logarithmic. A spike in this graph at zero usually indicates that the volume has been masked.

7.2 Volume estimate [\(i\)](#)

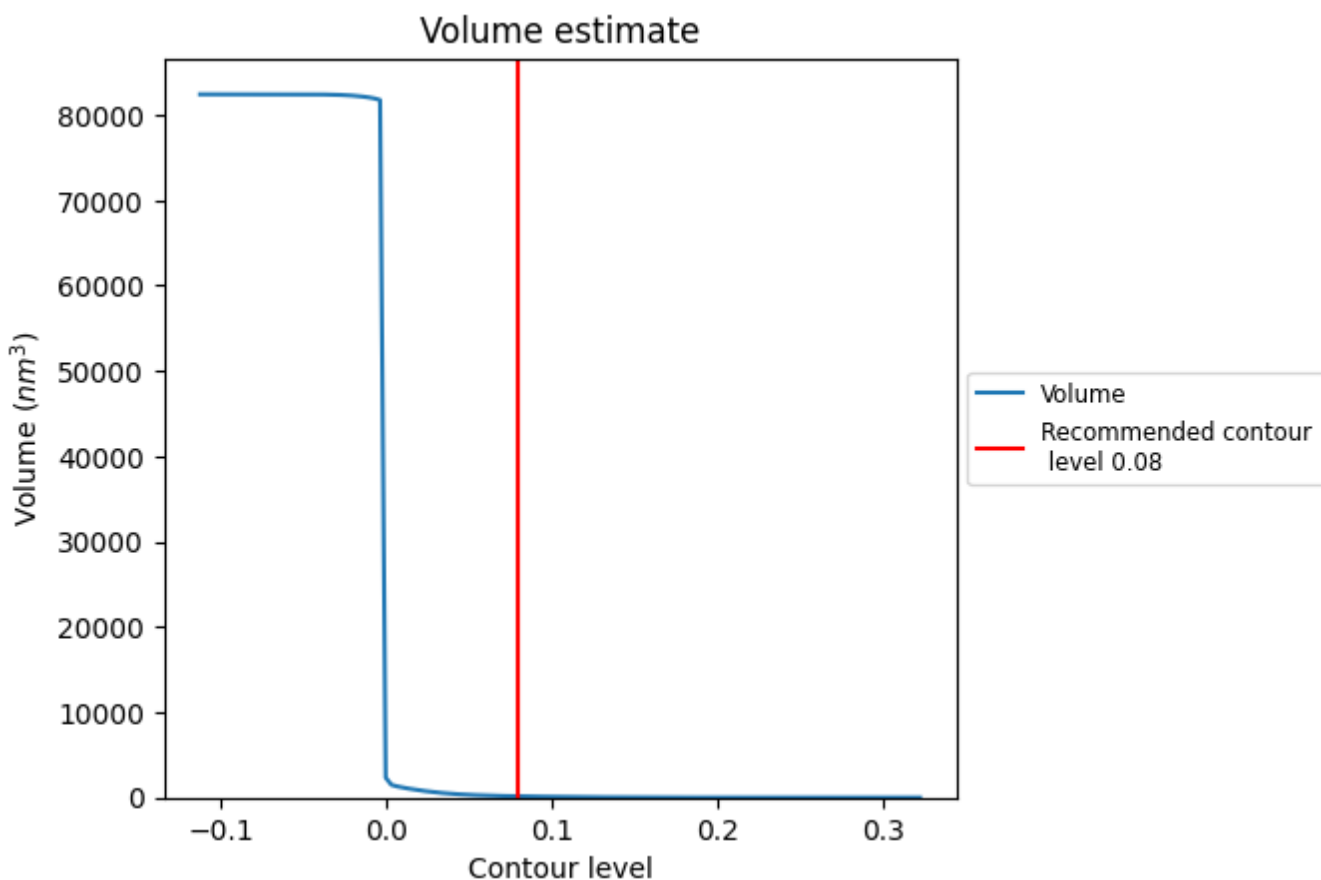

The volume at the recommended contour level is 148 nm³; this corresponds to an approximate mass of 134 kDa.

The volume estimate graph shows how the enclosed volume varies with the contour level. The recommended contour level is shown as a vertical line and the intersection between the line and the curve gives the volume of the enclosed surface at the given level.

7.3 Rotationally averaged power spectrum i

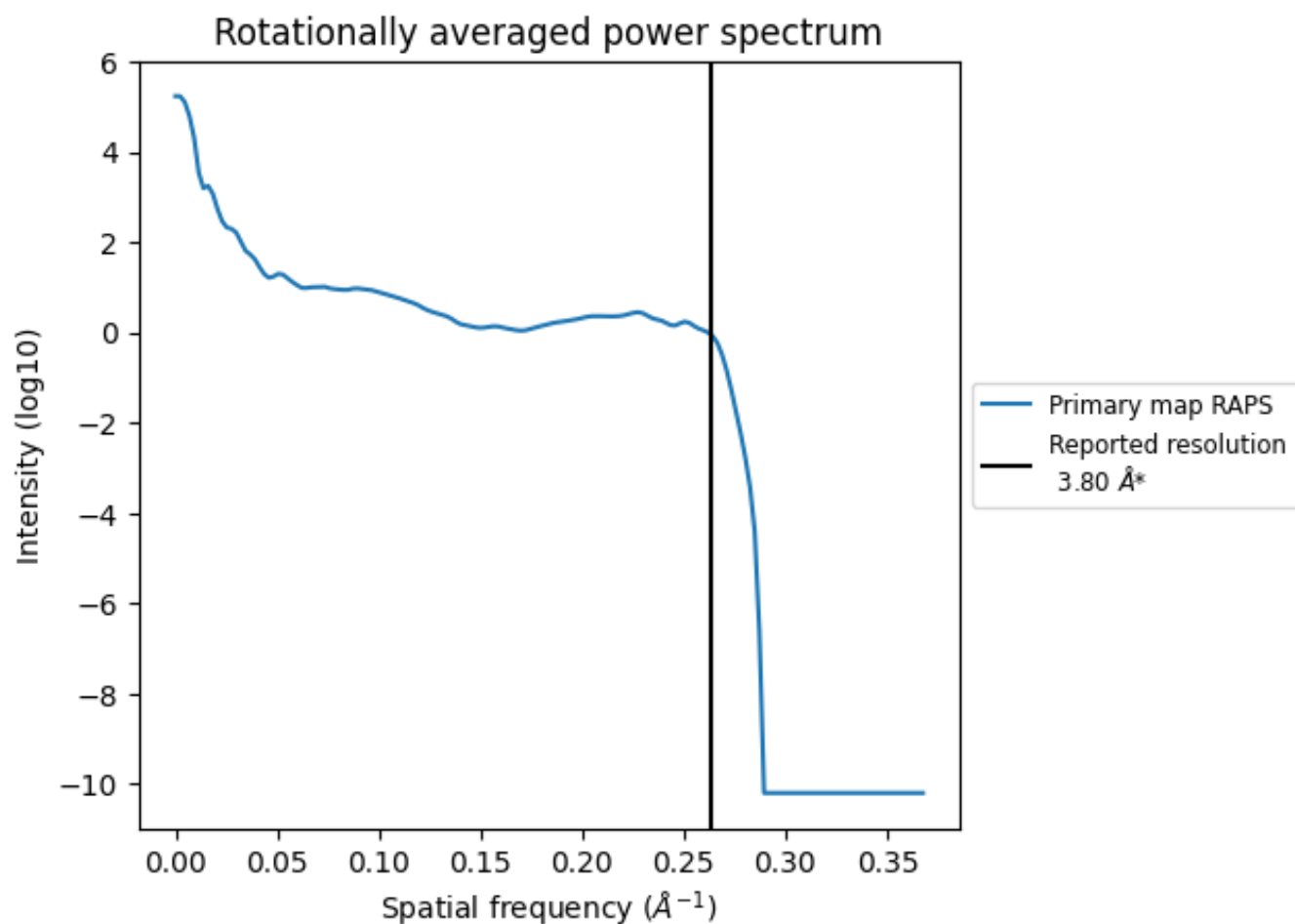

*Reported resolution corresponds to spatial frequency of 0.263 Å⁻¹

8 Fourier-Shell correlation

This section was not generated. No FSC curve or half-maps provided.

9 Map-model fit [i](#)

This section contains information regarding the fit between EMDB map EMD-9294 and PDB model 6MYY. Per-residue inclusion information can be found in section [3](#) on page [11](#).

9.1 Map-model overlay [i](#)

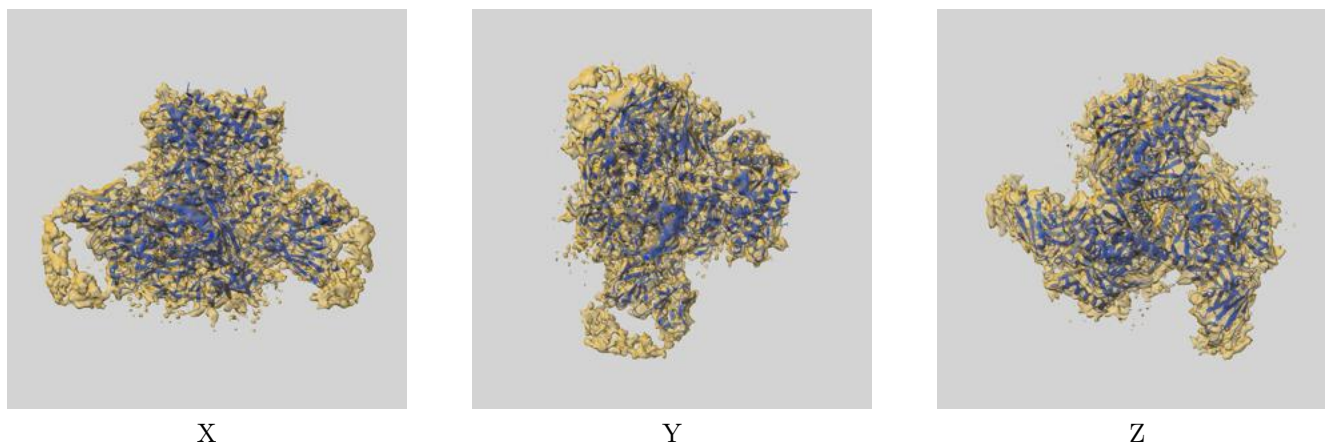

The images above show the 3D surface view of the map at the recommended contour level 0.08 at 50% transparency in yellow overlaid with a ribbon representation of the model coloured in blue. These images allow for the visual assessment of the quality of fit between the atomic model and the map.

9.2 Q-score mapped to coordinate model [i](#)

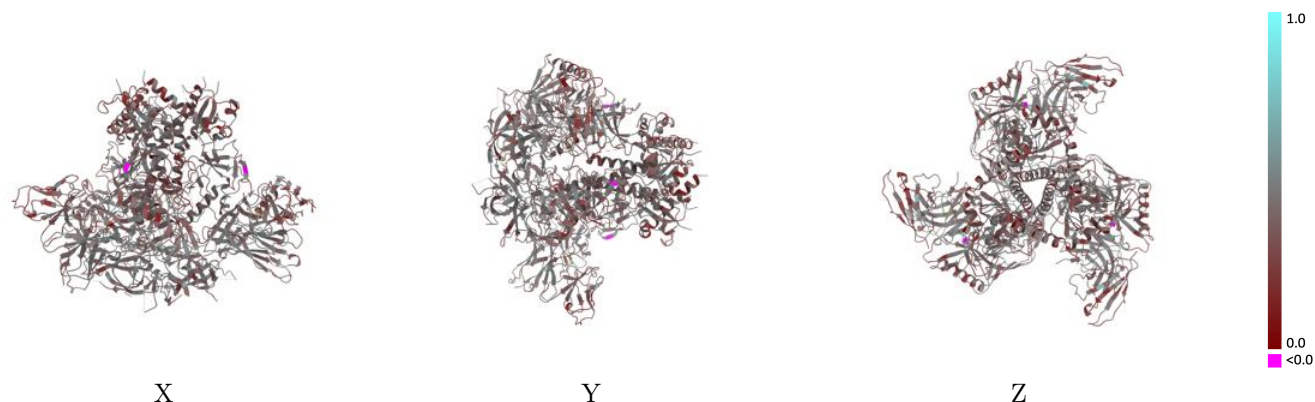

The images above show the model with each residue coloured according to its Q-score. This shows their resolvability in the map with higher Q-score values reflecting better resolvability. Please note: Q-score is calculating the resolvability of atoms, and thus high values are only expected at resolutions at which atoms can be resolved. Low Q-score values may therefore be expected for many entries.

9.3 Atom inclusion mapped to coordinate model [i](#)

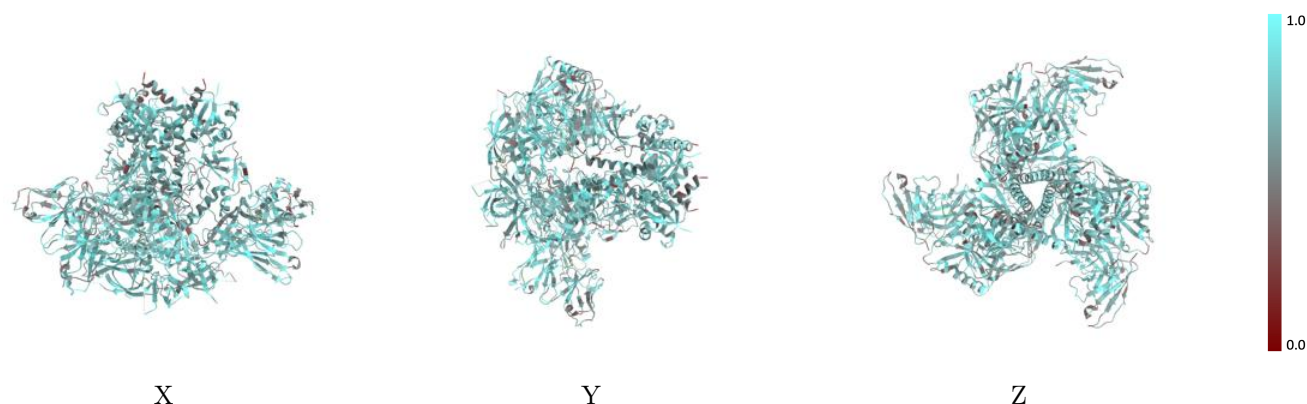

The images above show the model with each residue coloured according to its atom inclusion. This shows to what extent they are inside the map at the recommended contour level (0.08).



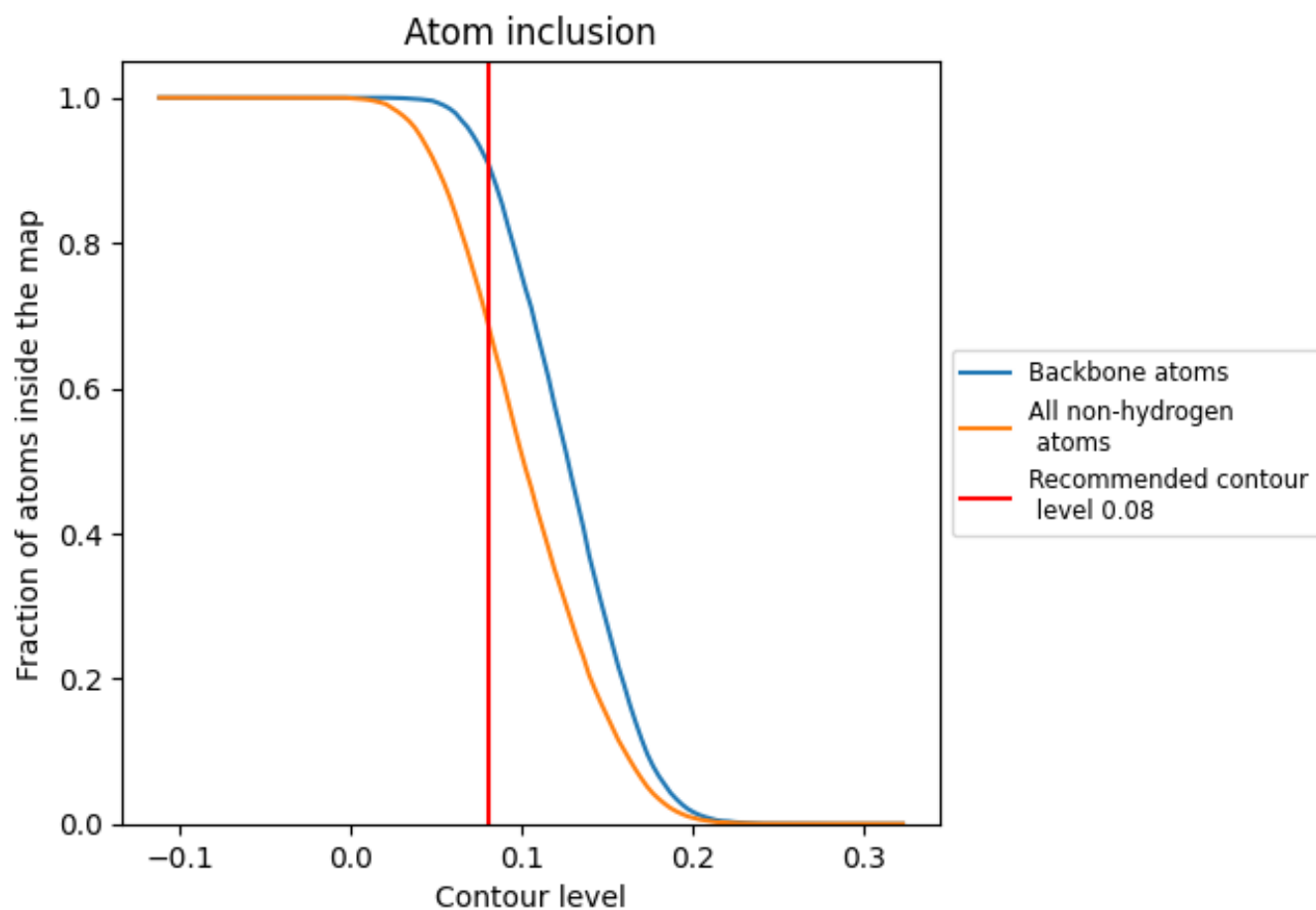



































































9.4 Atom inclusion [i](#)



At the recommended contour level, 91% of all backbone atoms, 69% of all non-hydrogen atoms, are inside the map.

9.5 Map-model fit summary



































The table lists the average atom inclusion at the recommended contour level (0.08) and Q-score for the entire model and for each chain.

Chain	Atom inclusion	Q-score
All	 0.6882	 0.3910
A	 0.7163	 0.3910
B	 0.7161	 0.3920
C	 0.6707	 0.3520
D	 0.7967	 0.4410
E	 0.7133	 0.3890
F	 0.6653	 0.3510
G	 0.7945	 0.4430
H	 0.7989	 0.4420
I	 0.2143	 0.3100
J	 0.2143	 0.3460
K	 0.2951	 0.3540
L	 0.6707	 0.3510
M	 0.4444	 0.4060
N	 0.4359	 0.4040
O	 0.4458	 0.3650
P	 0.4103	 0.2780
Q	 0.2564	 0.3450
R	 0.3800	 0.4120
S	 0.3571	 0.4230
T	 0.4098	 0.3840
U	 0.2500	 0.3550
V	 0.4286	 0.2740
W	 0.2143	 0.3210
X	 0.1786	 0.3070
Y	 0.2143	 0.3470
Z	 0.3115	 0.3560
a	 0.4722	 0.4140
b	 0.3846	 0.3900
c	 0.4458	 0.3640
d	 0.4103	 0.2880
e	 0.2564	 0.3390
f	 0.3800	 0.4060
g	 0.3571	 0.4120
h	 0.4262	 0.3930



Continued on next page...

Continued from previous page...

Chain	Atom inclusion	Q-score
i	 0.2500	 0.3480
j	 0.4286	 0.2850
k	 0.2143	 0.2970
l	 0.2143	 0.2970
m	 0.2143	 0.3410
n	 0.2951	 0.3570
o	 0.4722	 0.4060
p	 0.4359	 0.3940
q	 0.4337	 0.3620
r	 0.3590	 0.2890
s	 0.2308	 0.3480
t	 0.3200	 0.3980
u	 0.3571	 0.4160
v	 0.3770	 0.3900
w	 0.2857	 0.3510
x	 0.4286	 0.2770
y	 0.2143	 0.3030