



## Full wwPDB EM Validation Report ⓘ

Jun 3, 2024 – 08:01 PM JST

PDB ID : 7V5M  
EMDB ID : EMD-31727  
Title : 20S+monoUb-CyclinB1-NT (S2)  
Authors : Xu, C.; Cong, Y.  
Deposited on : 2021-08-17  
Resolution : 3.88 Å (reported)

This is a Full wwPDB EM Validation Report for a publicly released PDB entry.

We welcome your comments at [validation@mail.wwpdb.org](mailto:validation@mail.wwpdb.org)

A user guide is available at

<https://www.wwpdb.org/validation/2017/EMValidationReportHelp>

with specific help available everywhere you see the ⓘ symbol.

The types of validation reports are described at

<http://www.wwpdb.org/validation/2017/FAQs#types>.

---

The following versions of software and data (see [references ⓘ](#)) were used in the production of this report:

EMDB validation analysis : 0.0.1.dev92  
MolProbity : 4.02b-467  
Percentile statistics : 20191225.v01 (using entries in the PDB archive December 25th 2019)  
MapQ : 1.9.13  
Ideal geometry (proteins) : Engh & Huber (2001)  
Ideal geometry (DNA, RNA) : Parkinson et al. (1996)  
Validation Pipeline (wwPDB-VP) : 2.36.2

# 1 Overall quality at a glance i

The following experimental techniques were used to determine the structure:  
*ELECTRON MICROSCOPY*

The reported resolution of this entry is 3.88 Å.

Percentile scores (ranging between 0-100) for global validation metrics of the entry are shown in the following graphic. The table shows the number of entries on which the scores are based.

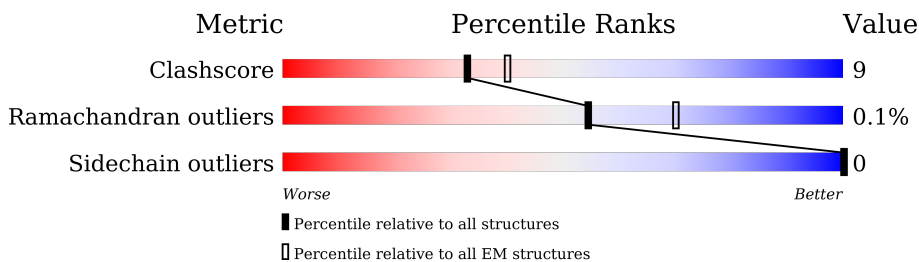

Metric	Whole archive (#Entries)	EM structures (#Entries)
Clashscore	158937	4297
Ramachandran outliers	154571	4023
Sidechain outliers	154315	3826

The table below summarises the geometric issues observed across the polymeric chains and their fit to the map. The red, orange, yellow and green segments of the bar indicate the fraction of residues that contain outliers for  $\geq 3$ , 2, 1 and 0 types of geometric quality criteria respectively. A grey segment represents the fraction of residues that are not modelled. The numeric value for each fraction is indicated below the corresponding segment, with a dot representing fractions  $\leq 5\%$ . The upper red bar (where present) indicates the fraction of residues that have poor fit to the EM map (all-atom inclusion  $< 40\%$ ). The numeric value is given above the bar.

Mol	Chain	Length	Quality of chain
1	A	246	
1	O	246	
2	B	234	
2	P	234	
3	C	261	
3	Q	261	
4	D	248	
4	R	248	

*Continued on next page...*

Continued from previous page...

Mol	Chain	Length	Quality of chain
5	E	241	
5	S	241	
6	F	263	
6	T	263	
7	G	255	
7	U	255	
8	H	205	
8	V	205	
9	I	234	
9	W	234	
10	J	205	
10	X	205	
11	K	201	
11	Y	201	
12	L	204	
12	Z	204	
13	M	213	
13	a	213	
14	N	219	
14	b	219	

## 2 Entry composition [i](#)

There are 14 unique types of molecules in this entry. The entry contains 45340 atoms, of which 0 are hydrogens and 0 are deuteriums.

In the tables below, the AltConf column contains the number of residues with at least one atom in alternate conformation and the Trace column contains the number of residues modelled with at most 2 atoms.

- Molecule 1 is a protein called Proteasome subunit alpha type-6.

Mol	Chain	Residues	Atoms					AltConf	Trace
			Total	C	N	O	S		
1	A	240	Total	C	N	O	S	0	0
			1734	1104	304	314	12		
1	O	240	Total	C	N	O	S	0	0
			1734	1104	304	314	12		

- Molecule 2 is a protein called Proteasome subunit alpha type-2.

Mol	Chain	Residues	Atoms					AltConf	Trace
			Total	C	N	O	S		
2	B	229	Total	C	N	O	S	0	0
			1662	1080	288	288	6		
2	P	229	Total	C	N	O	S	0	0
			1662	1080	288	288	6		

- Molecule 3 is a protein called Proteasome subunit alpha type-4.

Mol	Chain	Residues	Atoms					AltConf	Trace
			Total	C	N	O	S		
3	C	247	Total	C	N	O	S	0	0
			1786	1143	320	313	10		
3	Q	247	Total	C	N	O	S	0	0
			1786	1143	320	313	10		

- Molecule 4 is a protein called Proteasome subunit alpha type-7.

Mol	Chain	Residues	Atoms					AltConf	Trace
			Total	C	N	O	S		
4	D	232	Total	C	N	O	S	0	0
			1633	1038	306	284	5		
4	R	232	Total	C	N	O	S	0	0
			1633	1038	306	284	5		

- Molecule 5 is a protein called Proteasome subunit alpha type-5.

Mol	Chain	Residues	Atoms					AltConf	Trace
5	E	233	Total	C	N	O	S	0	0
			1659	1056	287	305	11		
5	S	233	Total	C	N	O	S	0	0
			1659	1056	287	305	11		

- Molecule 6 is a protein called Proteasome subunit alpha type-1.

Mol	Chain	Residues	Atoms					AltConf	Trace
6	F	233	Total	C	N	O	S	0	0
			1704	1087	315	293	9		
6	T	233	Total	C	N	O	S	0	0
			1704	1087	315	293	9		

- Molecule 7 is a protein called Proteasome subunit alpha type-3.

Mol	Chain	Residues	Atoms					AltConf	Trace
7	G	239	Total	C	N	O	S	0	0
			1760	1131	308	311	10		
7	U	239	Total	C	N	O	S	0	0
			1760	1131	308	311	10		

- Molecule 8 is a protein called Proteasome subunit beta type-6.

Mol	Chain	Residues	Atoms					AltConf	Trace
8	H	202	Total	C	N	O	S	0	0
			1465	926	256	271	12		
8	V	202	Total	C	N	O	S	0	0
			1465	926	256	271	12		

- Molecule 9 is a protein called Proteasome subunit beta type-7.

Mol	Chain	Residues	Atoms					AltConf	Trace
9	I	220	Total	C	N	O	S	0	0
			1576	1003	272	292	9		
9	W	220	Total	C	N	O	S	0	0
			1576	1003	272	292	9		

- Molecule 10 is a protein called Proteasome subunit beta type-3.

Mol	Chain	Residues	Atoms					AltConf	Trace
10	J	204	Total	C	N	O	S	0	0
			1534	987	262	267	18		

*Continued on next page...*

*Continued from previous page...*

Mol	Chain	Residues	Atoms					AltConf	Trace
10	X	204	Total	C	N	O	S	0	0
			1534	987	262	267	18		

- Molecule 11 is a protein called Proteasome subunit beta type-2.

Mol	Chain	Residues	Atoms					AltConf	Trace
11	K	196	Total	C	N	O	S	0	0
			1506	973	259	266	8		
11	Y	196	Total	C	N	O	S	0	0
			1506	973	259	266	8		

- Molecule 12 is a protein called Proteasome subunit beta type-5.

Mol	Chain	Residues	Atoms					AltConf	Trace
12	L	200	Total	C	N	O	S	0	0
			1500	954	270	267	9		
12	Z	200	Total	C	N	O	S	0	0
			1500	954	270	267	9		

- Molecule 13 is a protein called Proteasome subunit beta type-1.

Mol	Chain	Residues	Atoms					AltConf	Trace
13	M	212	Total	C	N	O	S	0	0
			1583	1016	279	278	10		
13	a	212	Total	C	N	O	S	0	0
			1583	1016	279	278	10		

- Molecule 14 is a protein called Proteasome subunit beta type-4.

Mol	Chain	Residues	Atoms					AltConf	Trace
14	N	212	Total	C	N	O	S	0	0
			1568	998	279	280	11		
14	b	212	Total	C	N	O	S	0	0
			1568	998	279	280	11		

### 3 Residue-property plots [i](#)

These plots are drawn for all protein, RNA, DNA and oligosaccharide chains in the entry. The first graphic for a chain summarises the proportions of the various outlier classes displayed in the second graphic. The second graphic shows the sequence view annotated by issues in geometry and atom inclusion in map density. Residues are color-coded according to the number of geometric quality criteria for which they contain at least one outlier: green = 0, yellow = 1, orange = 2 and red = 3 or more. A red diamond above a residue indicates a poor fit to the EM map for this residue (all-atom inclusion < 40%). Stretches of 2 or more consecutive residues without any outlier are shown as a green connector. Residues present in the sample, but not in the model, are shown in grey.

- Molecule 1: Proteasome subunit alpha type-6

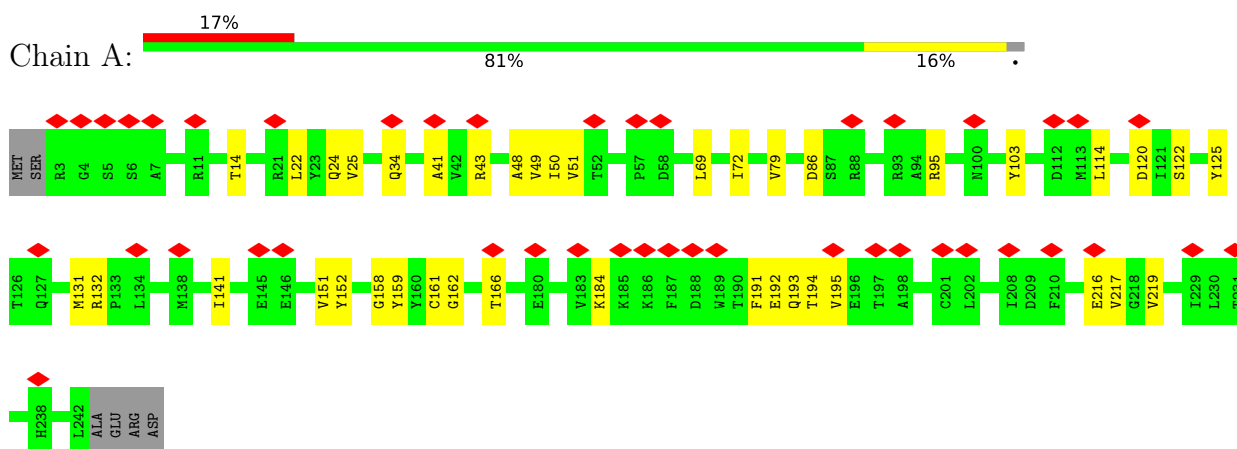

- Molecule 1: Proteasome subunit alpha type-6

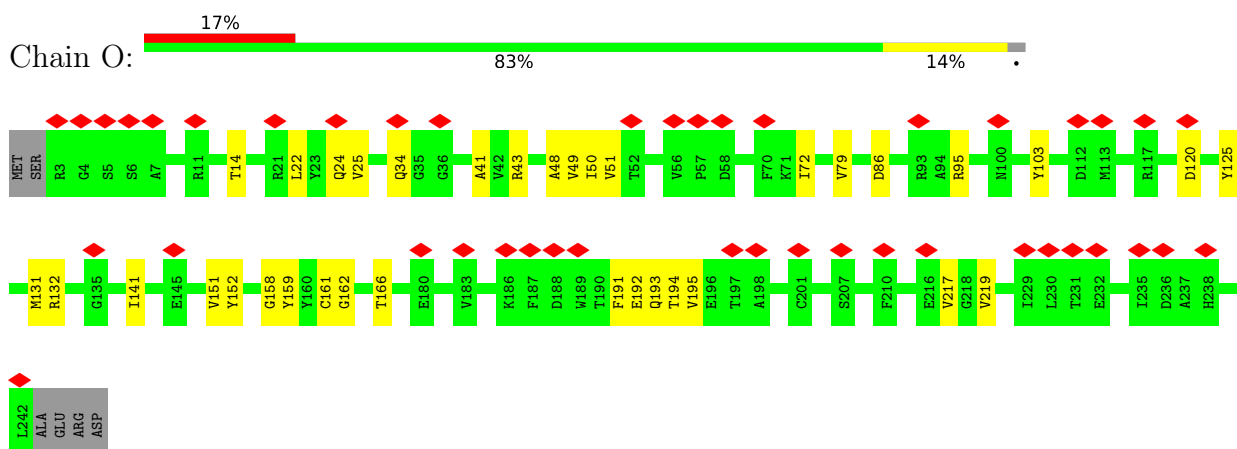

- Molecule 2: Proteasome subunit alpha type-2

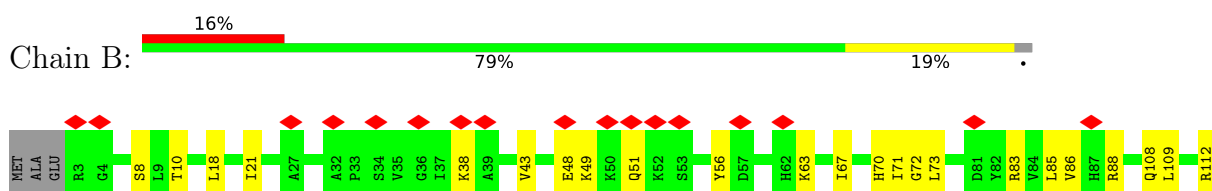

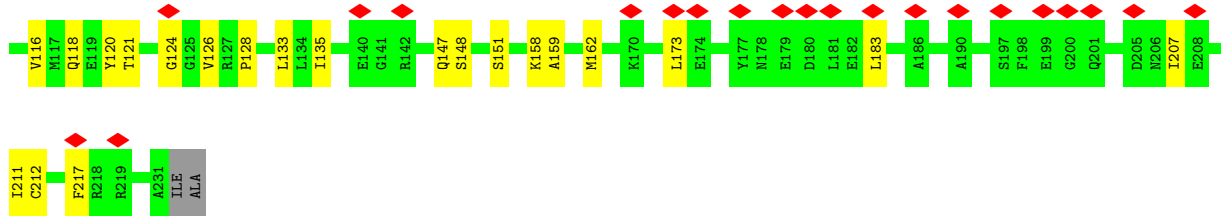

• Molecule 2: Proteasome subunit alpha type-2

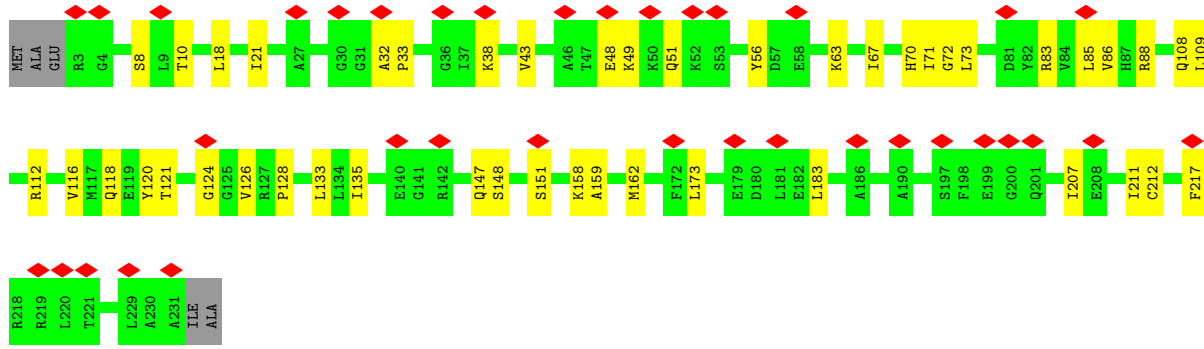
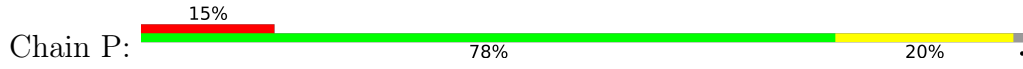

• Molecule 3: Proteasome subunit alpha type-4

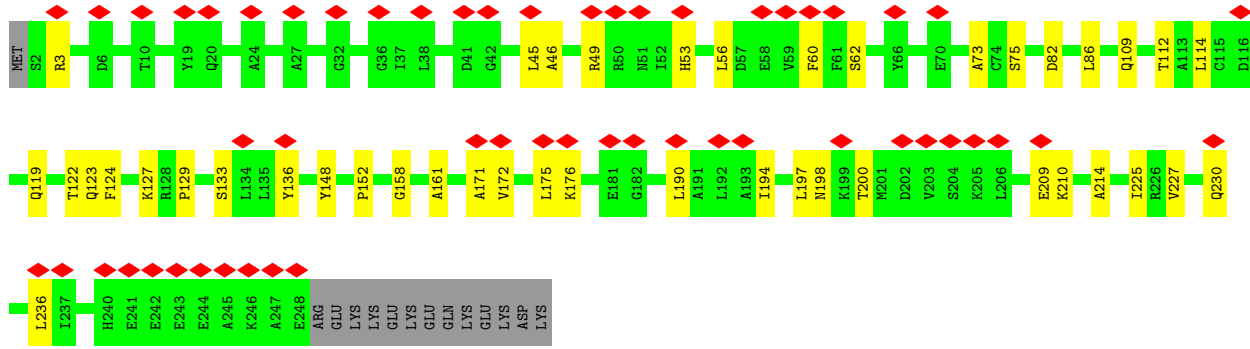
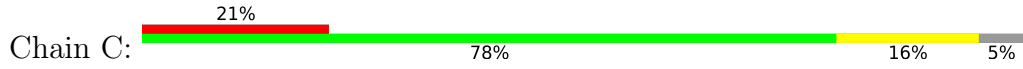

• Molecule 3: Proteasome subunit alpha type-4

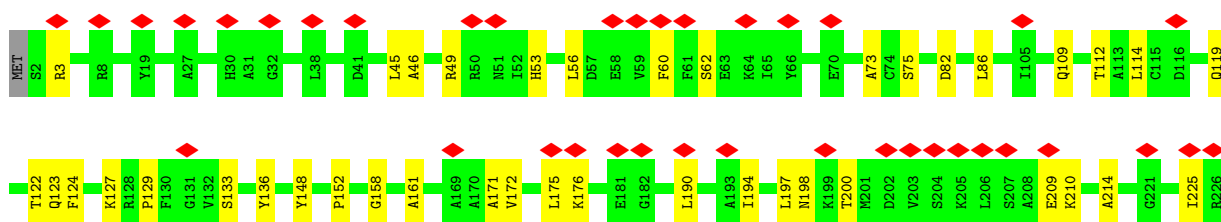
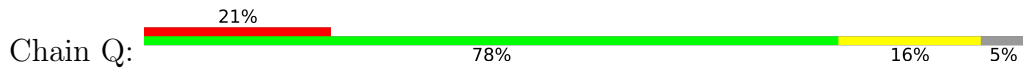



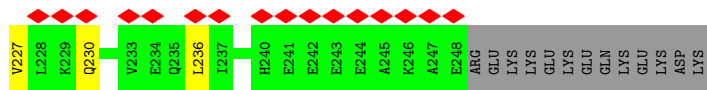

• Molecule 4: Proteasome subunit alpha type-7

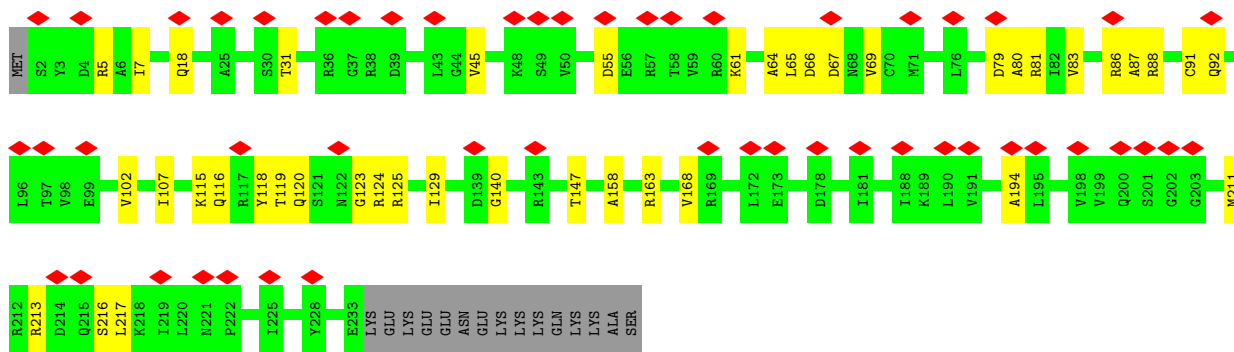
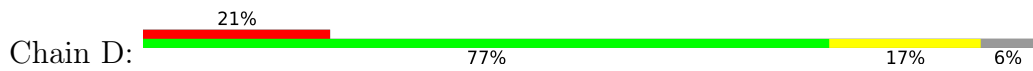

• Molecule 4: Proteasome subunit alpha type-7

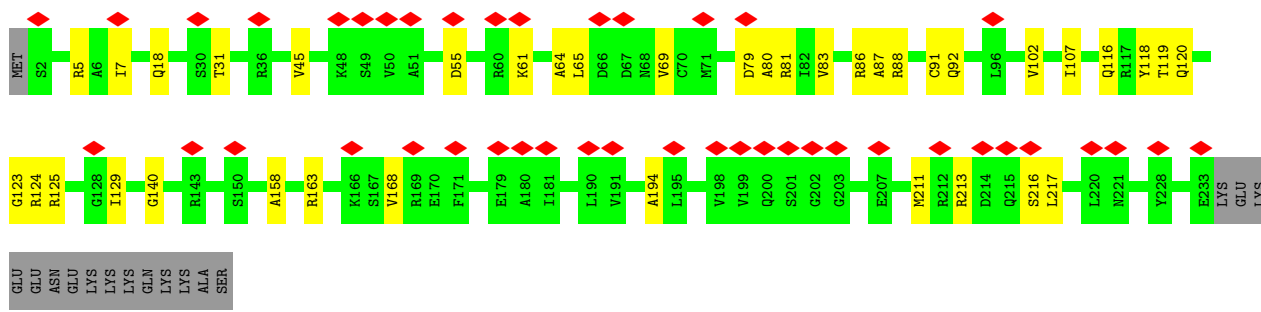
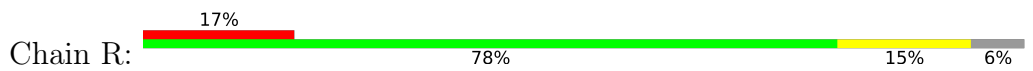

• Molecule 5: Proteasome subunit alpha type-5

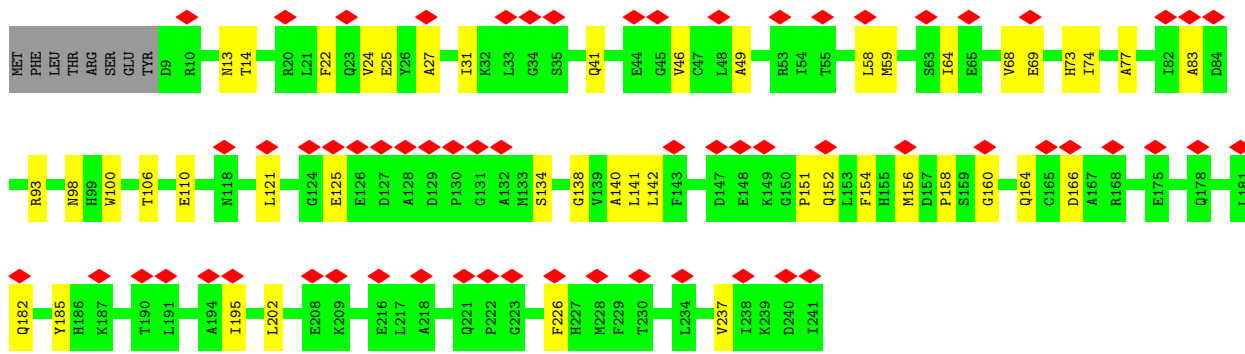
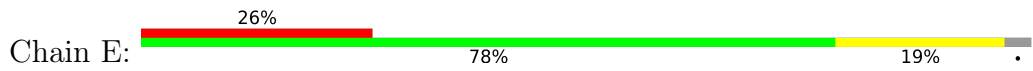

• Molecule 5: Proteasome subunit alpha type-5

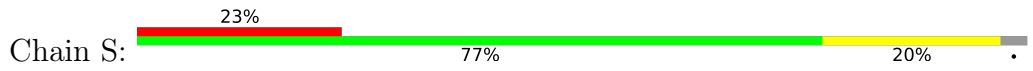

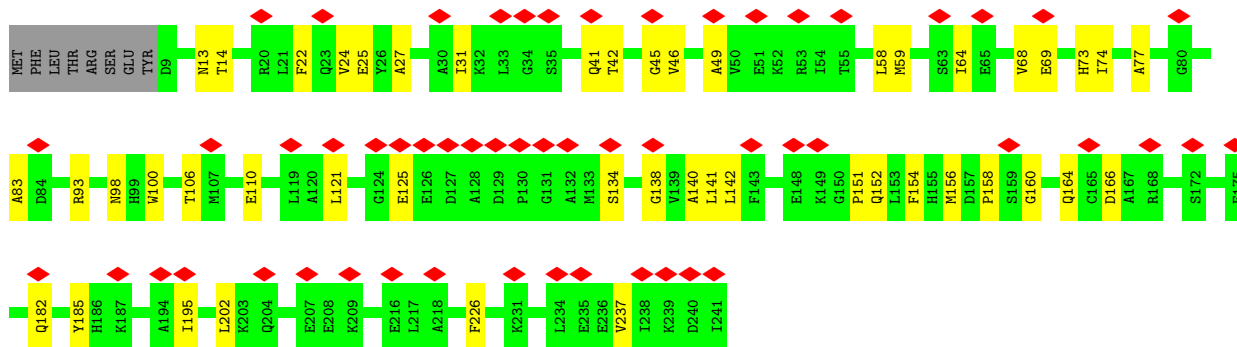

- Molecule 6: Proteasome subunit alpha type-1

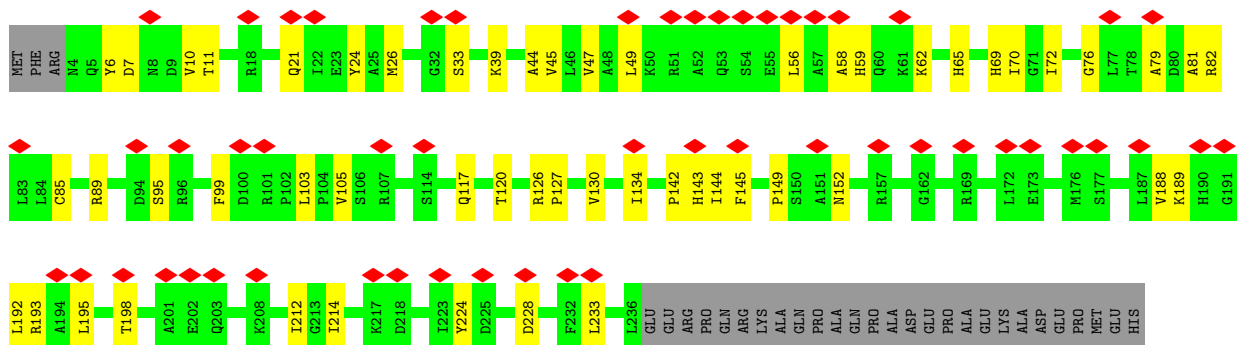

- Molecule 6: Proteasome subunit alpha type-1

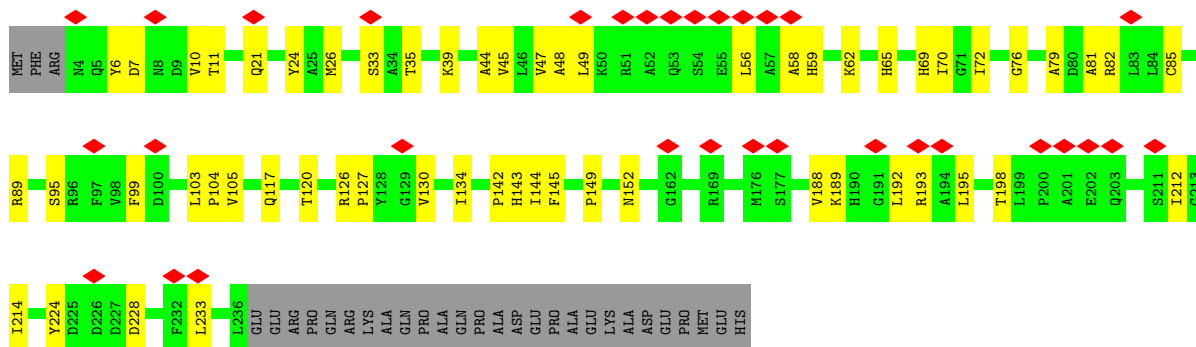

- Molecule 7: Proteasome subunit alpha type-3

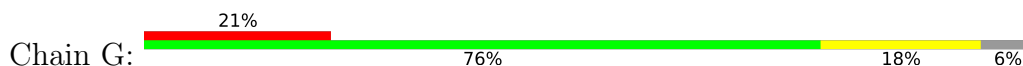

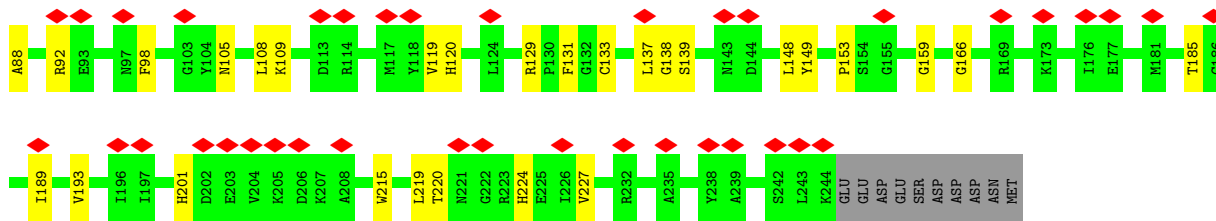

- Molecule 7: Proteasome subunit alpha type-3

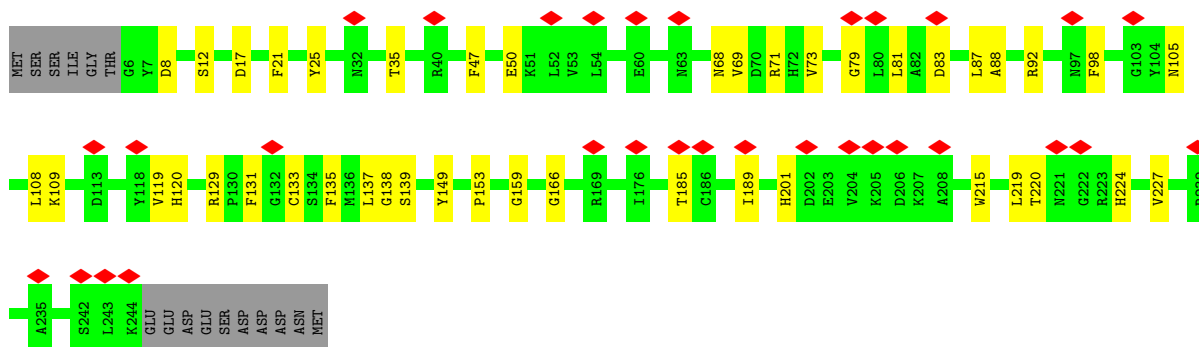
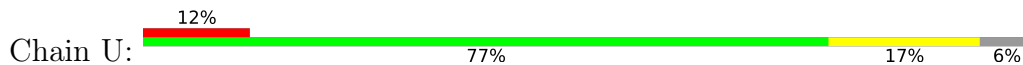

- Molecule 8: Proteasome subunit beta type-6

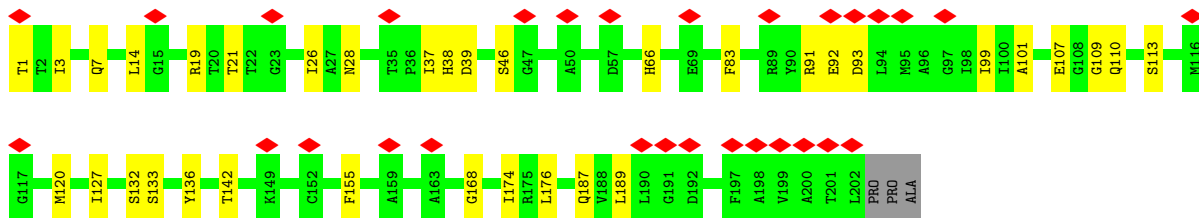
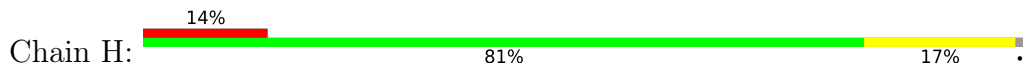

- Molecule 8: Proteasome subunit beta type-6

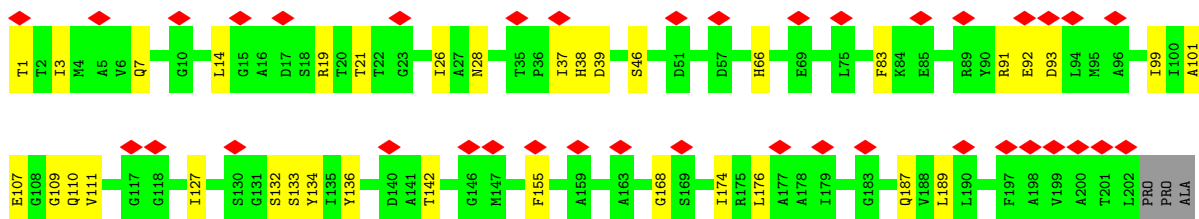
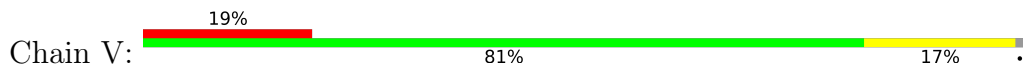

- Molecule 9: Proteasome subunit beta type-7



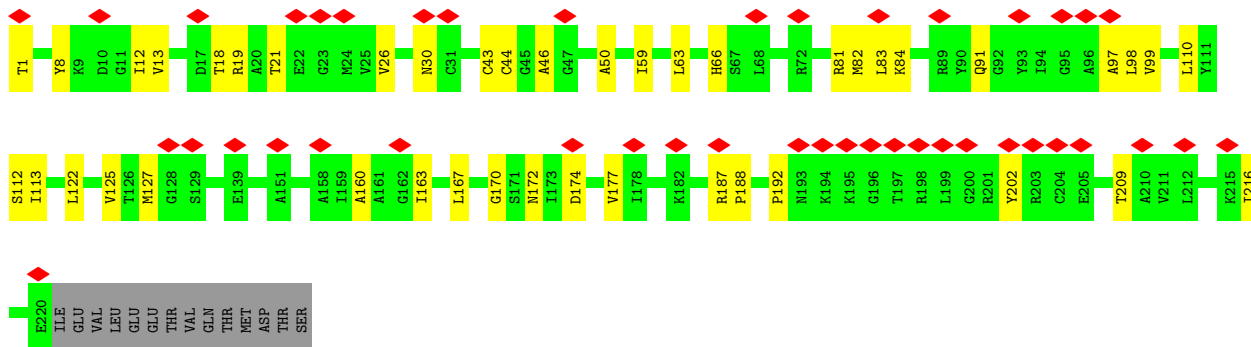

• Molecule 9: Proteasome subunit beta type-7

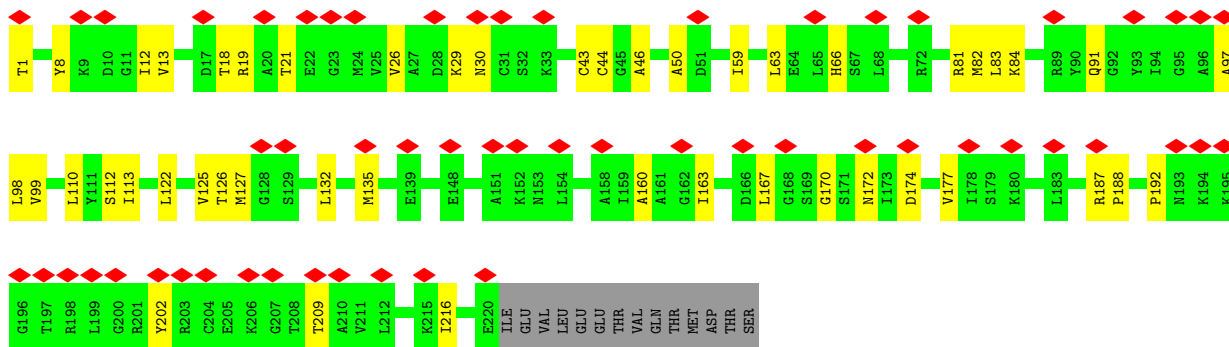
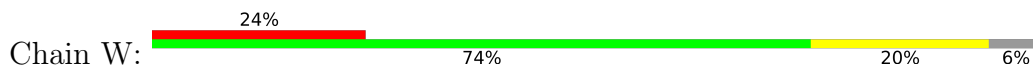

• Molecule 10: Proteasome subunit beta type-3

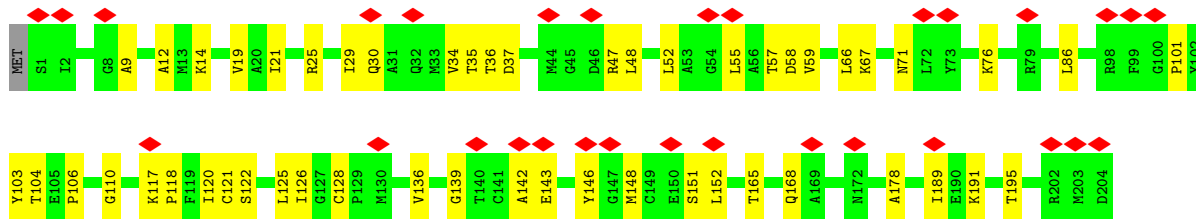
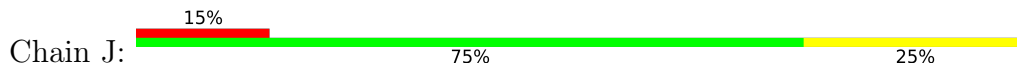

• Molecule 10: Proteasome subunit beta type-3

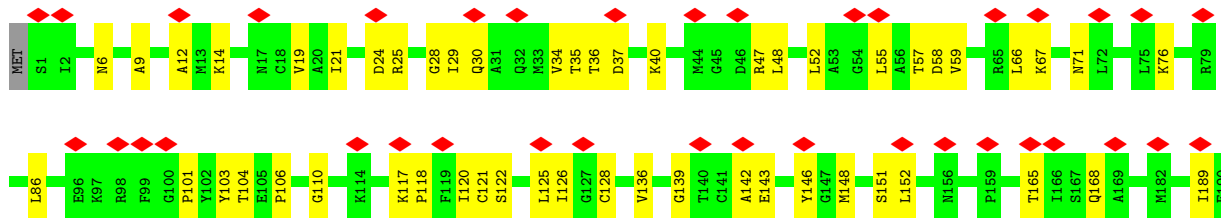
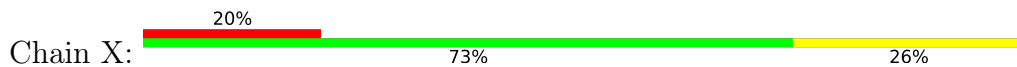

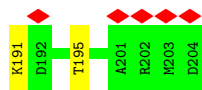

• Molecule 11: Proteasome subunit beta type-2

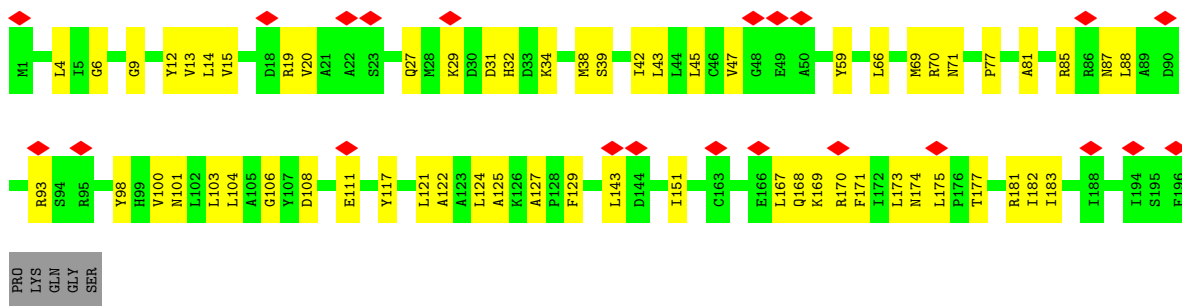

• Molecule 11: Proteasome subunit beta type-2

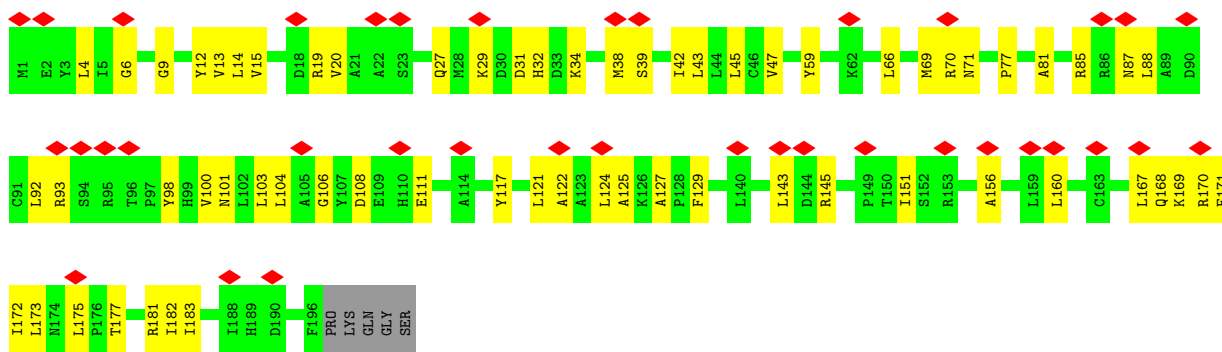

• Molecule 12: Proteasome subunit beta type-5

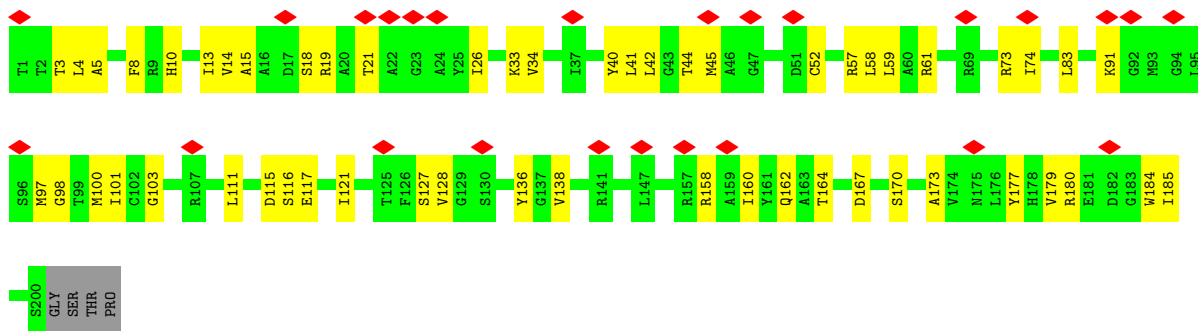

• Molecule 12: Proteasome subunit beta type-5



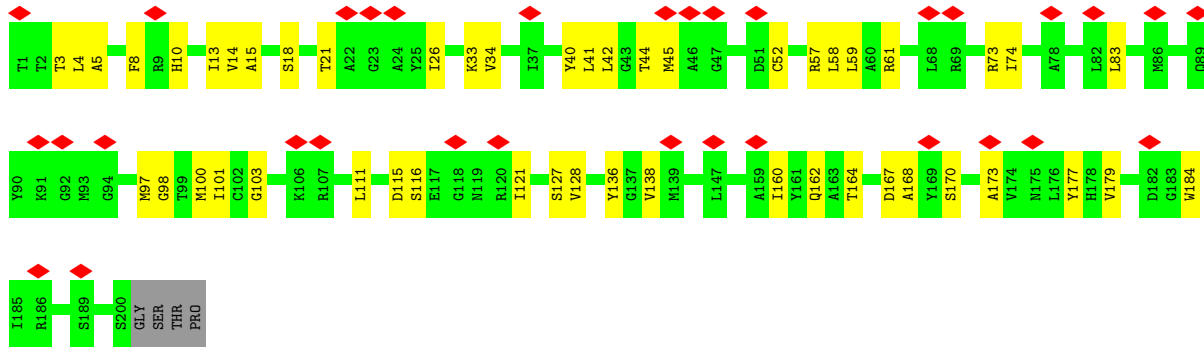

• Molecule 13: Proteasome subunit beta type-1

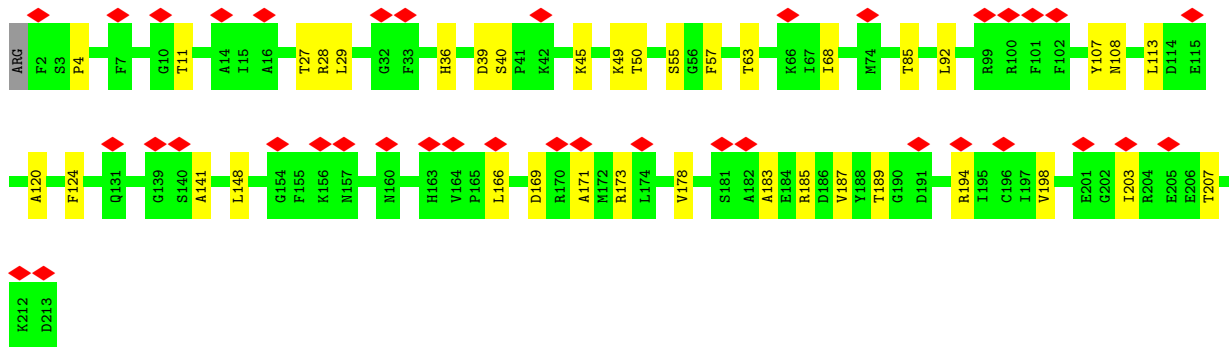
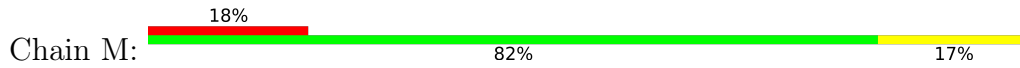

• Molecule 13: Proteasome subunit beta type-1

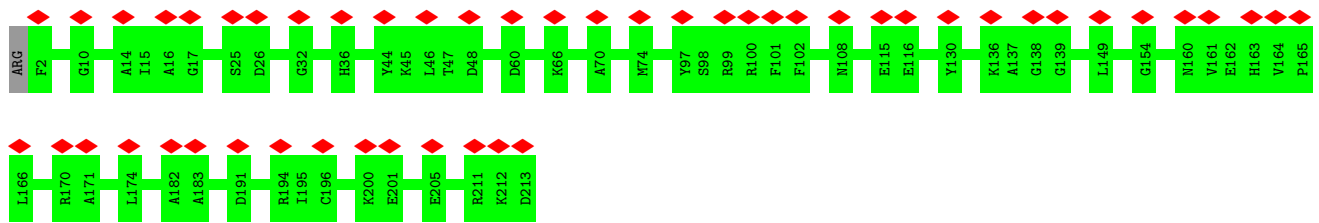

• Molecule 14: Proteasome subunit beta type-4

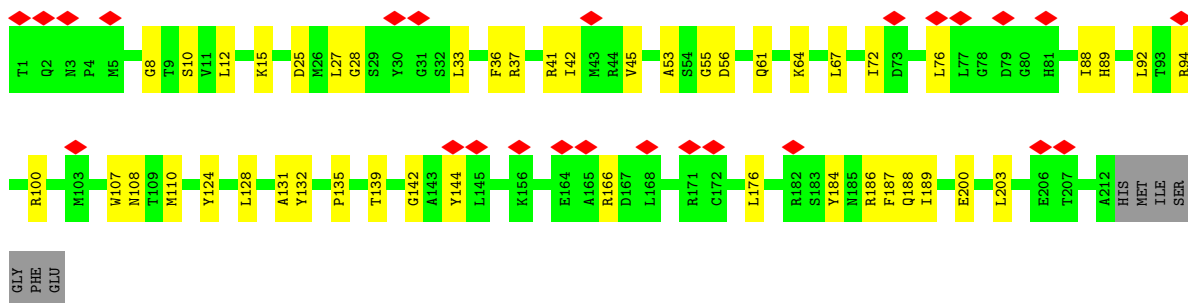
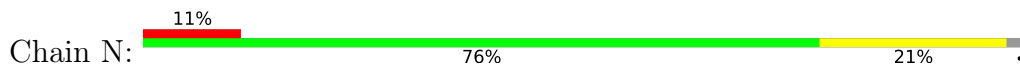

• Molecule 14: Proteasome subunit beta type-4

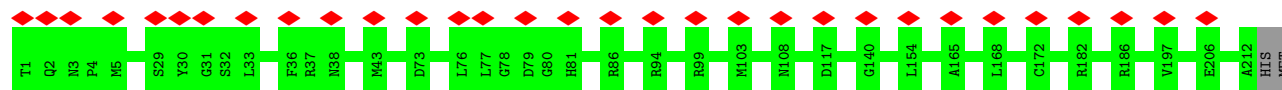

ILE  
SER  
GLY  
PHE  
GLU

## 4 Experimental information

Property	Value	Source
EM reconstruction method	SINGLE PARTICLE	Depositor
Imposed symmetry	POINT, Not provided	
Number of particles used	179590	Depositor
Resolution determination method	FSC 0.143 CUT-OFF	Depositor
CTF correction method	PHASE FLIPPING AND AMPLITUDE CORRECTION	Depositor
Microscope	FEI TITAN KRIOS	Depositor
Voltage (kV)	300	Depositor
Electron dose ( $e^-/\text{\AA}^2$ )	38	Depositor
Minimum defocus (nm)	Not provided	
Maximum defocus (nm)	Not provided	
Magnification	Not provided	
Image detector	GATAN K2 SUMMIT (4k x 4k)	Depositor
Maximum map value	0.042	Depositor
Minimum map value	-0.017	Depositor
Average map value	-0.000	Depositor
Map value standard deviation	0.003	Depositor
Recommended contour level	0.0135	Depositor
Map size (Å)	263.6, 263.6, 263.6	wwPDB
Map dimensions	200, 200, 200	wwPDB
Map angles (°)	90.0, 90.0, 90.0	wwPDB
Pixel spacing (Å)	1.3180001, 1.3180001, 1.3180001	Depositor



## 5 Model quality [i](#)

### 5.1 Standard geometry [i](#)

The Z score for a bond length (or angle) is the number of standard deviations the observed value is removed from the expected value. A bond length (or angle) with  $|Z| > 5$  is considered an outlier worth inspection. RMSZ is the root-mean-square of all Z scores of the bond lengths (or angles).

Mol	Chain	Bond lengths		Bond angles	
		RMSZ	# Z  >5	RMSZ	# Z  >5
1	A	0.24	0/1763	0.44	0/2393
1	O	0.24	0/1763	0.43	0/2393
2	B	0.24	0/1701	0.41	0/2318
2	P	0.24	0/1701	0.41	0/2318
3	C	0.23	0/1815	0.43	0/2466
3	Q	0.23	0/1815	0.43	0/2466
4	D	0.23	0/1657	0.43	0/2261
4	R	0.23	0/1657	0.43	0/2261
5	E	0.24	0/1685	0.42	0/2290
5	S	0.24	0/1685	0.42	0/2290
6	F	0.23	0/1738	0.42	0/2364
6	T	0.23	0/1738	0.42	0/2364
7	G	0.24	0/1795	0.41	0/2434
7	U	0.24	0/1795	0.41	0/2434
8	H	0.24	0/1491	0.43	0/2021
8	V	0.24	0/1491	0.43	0/2021
9	I	0.23	0/1603	0.44	0/2180
9	W	0.23	0/1603	0.44	0/2180
10	J	0.24	0/1563	0.44	0/2113
10	X	0.24	0/1563	0.44	0/2113
11	K	0.24	0/1538	0.44	0/2088
11	Y	0.24	0/1538	0.44	0/2088
12	L	0.24	0/1531	0.43	0/2076
12	Z	0.23	0/1531	0.43	0/2076
13	M	0.24	0/1613	0.44	0/2178
13	a	0.24	0/1613	0.44	0/2178
14	N	0.24	0/1598	0.44	0/2170
14	b	0.24	0/1598	0.44	0/2170
All	All	0.24	0/46182	0.43	0/62704

There are no bond length outliers.

There are no bond angle outliers.

There are no chirality outliers.

There are no planarity outliers.

## 5.2 Too-close contacts

In the following table, the Non-H and H(model) columns list the number of non-hydrogen atoms and hydrogen atoms in the chain respectively. The H(added) column lists the number of hydrogen atoms added and optimized by MolProbity. The Clashes column lists the number of clashes within the asymmetric unit, whereas Symm-Clashes lists symmetry-related clashes.

Mol	Chain	Non-H	H(model)	H(added)	Clashes	Symm-Clashes
1	A	1734	0	1652	25	0
1	O	1734	0	1652	22	0
2	B	1662	0	1590	30	0
2	P	1662	0	1590	31	0
3	C	1786	0	1717	26	0
3	Q	1786	0	1717	26	0
4	D	1633	0	1518	32	0
4	R	1633	0	1518	30	0
5	E	1659	0	1589	35	0
5	S	1659	0	1589	35	0
6	F	1704	0	1638	42	0
6	T	1704	0	1638	45	0
7	G	1760	0	1680	31	0
7	U	1760	0	1680	29	0
8	H	1465	0	1419	22	0
8	V	1465	0	1419	22	0
9	I	1576	0	1558	35	0
9	W	1576	0	1558	42	0
10	J	1534	0	1539	37	0
10	X	1534	0	1539	37	0
11	K	1506	0	1475	55	0
11	Y	1506	0	1475	58	0
12	L	1500	0	1441	39	0
12	Z	1500	0	1441	36	0
13	M	1583	0	1579	30	0
13	a	1583	0	1579	0	0
14	N	1568	0	1513	35	0
14	b	1568	0	1513	0	0
All	All	45340	0	43816	767	0

The all-atom clashscore is defined as the number of clashes found per 1000 atoms (including hydrogen atoms). The all-atom clashscore for this structure is 9.

All (767) close contacts within the same asymmetric unit are listed below, sorted by their clash magnitude.

Atom-1	Atom-2	Interatomic distance (Å)	Clash overlap (Å)
9:I:187:ARG:HB3	9:I:188:PRO:HD3	1.32	1.11
9:W:187:ARG:HB3	9:W:188:PRO:HD3	1.32	1.07
5:E:121:LEU:HD12	6:F:79:ALA:HB3	1.63	0.80
5:S:121:LEU:HD12	6:T:79:ALA:HB3	1.63	0.80
4:D:211:MET:HB2	4:D:217:LEU:HD12	1.66	0.78
4:R:211:MET:HB2	4:R:217:LEU:HD12	1.65	0.78
7:G:35:THR:HA	7:G:166:GLY:HA3	1.68	0.75
12:Z:97:MET:HG2	12:Z:98:GLY:H	1.52	0.75
7:U:35:THR:HA	7:U:166:GLY:HA3	1.68	0.74
4:D:140:GLY:O	4:D:213:ARG:NH1	2.21	0.73
12:L:97:MET:HG2	12:L:98:GLY:H	1.52	0.73
9:W:187:ARG:HB3	9:W:188:PRO:CD	2.17	0.73
12:L:97:MET:HB3	12:L:116:SER:HB3	1.72	0.71
4:R:140:GLY:O	4:R:213:ARG:NH1	2.22	0.71
11:Y:19:ARG:HB3	11:Y:31:ASP:HA	1.72	0.71
11:K:19:ARG:HB3	11:K:31:ASP:HA	1.72	0.70
9:I:187:ARG:HB3	9:I:188:PRO:CD	2.17	0.70
12:Z:97:MET:HB3	12:Z:116:SER:HB3	1.72	0.70
2:B:159:ALA:HB1	2:B:173:LEU:HD23	1.75	0.68
12:L:14:VAL:HG21	12:L:42:LEU:HD11	1.75	0.68
14:N:56:ASP:O	14:N:108:ASN:ND2	2.24	0.68
10:X:29:ILE:HG22	10:X:30:GLN:H	1.58	0.68
12:Z:14:VAL:HG21	12:Z:42:LEU:HD11	1.75	0.68
10:J:29:ILE:HG22	10:J:30:GLN:H	1.58	0.68
1:A:41:ALA:HB3	1:A:166:THR:HB	1.77	0.67
1:A:49:VAL:HG11	1:A:195:VAL:HA	1.76	0.67
9:I:110:LEU:HD21	9:I:125:VAL:HG22	1.77	0.67
9:W:163:ILE:HG12	9:W:170:GLY:HA2	1.76	0.67
1:O:41:ALA:HB3	1:O:166:THR:HB	1.76	0.67
2:P:159:ALA:HB1	2:P:173:LEU:HD23	1.75	0.67
2:P:85:LEU:HD21	2:P:133:LEU:HD11	1.78	0.66
6:F:44:ALA:HB2	6:F:142:PRO:HB3	1.78	0.66
1:O:49:VAL:HG11	1:O:195:VAL:HA	1.76	0.66
3:Q:112:THR:HG23	4:R:81:ARG:HD2	1.78	0.66
6:T:44:ALA:HB2	6:T:142:PRO:HB3	1.78	0.66
9:I:163:ILE:HG12	9:I:170:GLY:HA2	1.76	0.66
2:B:85:LEU:HD21	2:B:133:LEU:HD11	1.78	0.65
9:W:110:LEU:HD21	9:W:125:VAL:HG22	1.77	0.65
6:F:72:ILE:HG22	6:F:134:ILE:HG12	1.79	0.65
11:K:27:GLN:NE2	11:Y:169:LYS:O	2.28	0.65
6:T:72:ILE:HG22	6:T:134:ILE:HG12	1.79	0.65
6:T:81:ALA:HB2	6:T:130:VAL:HG21	1.79	0.65

*Continued on next page...*

*Continued from previous page...*

Atom-1	Atom-2	Interatomic distance (Å)	Clash overlap (Å)
8:H:7:GLN:NE2	8:H:109:GLY:O	2.29	0.64
9:I:187:ARG:CB	9:I:188:PRO:HD3	2.17	0.64
6:F:95:SER:HB3	6:F:103:LEU:HD12	1.78	0.64
10:J:104:THR:HG23	10:J:106:PRO:HD3	1.80	0.64
3:C:112:THR:HG23	4:D:81:ARG:HD2	1.78	0.64
4:R:86:ARG:NH1	4:R:118:TYR:OH	2.27	0.64
6:T:95:SER:HB3	6:T:103:LEU:HD12	1.78	0.64
8:V:7:GLN:NE2	8:V:109:GLY:O	2.29	0.64
6:F:81:ALA:HB2	6:F:130:VAL:HG21	1.79	0.64
8:H:107:GLU:OE1	8:H:110:GLN:NE2	2.31	0.64
4:D:5:ARG:O	4:D:123:GLY:N	2.30	0.63
4:D:86:ARG:NH1	4:D:118:TYR:OH	2.27	0.63
8:V:14:LEU:HD21	8:V:101:ALA:HB3	1.80	0.63
13:M:49:LYS:O	13:M:50:THR:OG1	2.16	0.63
10:X:34:VAL:HG12	10:X:35:THR:HG23	1.80	0.63
3:C:194:ILE:O	3:C:198:ASN:ND2	2.32	0.63
10:J:34:VAL:HG12	10:J:35:THR:HG23	1.80	0.63
9:I:21:THR:HG22	9:I:26:VAL:HA	1.80	0.63
3:Q:194:ILE:O	3:Q:198:ASN:ND2	2.31	0.63
9:W:187:ARG:CB	9:W:188:PRO:HD3	2.17	0.63
10:X:25:ARG:HH11	10:X:37:ASP:HA	1.64	0.63
10:X:104:THR:HG23	10:X:106:PRO:HD3	1.80	0.63
5:S:13:ASN:HB3	6:T:126:ARG:HB3	1.81	0.63
13:M:45:LYS:HE3	13:M:203:ILE:HD12	1.80	0.63
2:P:147:GLN:NE2	2:P:162:MET:SD	2.72	0.63
8:H:120:MET:O	14:N:61:GLN:NE2	2.27	0.62
9:W:21:THR:HG22	9:W:26:VAL:HA	1.80	0.62
11:K:169:LYS:O	11:Y:27:GLN:NE2	2.32	0.62
2:B:147:GLN:NE2	2:B:162:MET:SD	2.72	0.62
7:G:50:GLU:OE2	7:G:201:HIS:ND1	2.33	0.62
8:V:107:GLU:OE1	8:V:110:GLN:NE2	2.31	0.62
7:U:50:GLU:OE2	7:U:201:HIS:ND1	2.33	0.62
3:C:136:TYR:HB2	3:C:148:TYR:HB2	1.82	0.62
8:H:14:LEU:HD21	8:H:101:ALA:HB3	1.80	0.62
2:P:51:GLN:HB3	2:P:56:TYR:HD2	1.64	0.62
14:N:61:GLN:HA	14:N:64:LYS:HD3	1.82	0.62
1:O:120:ASP:OD1	2:P:83:ARG:NH1	2.33	0.62
5:E:164:GLN:HB3	6:F:58:ALA:HB3	1.82	0.62
10:J:25:ARG:HH11	10:J:37:ASP:HA	1.64	0.61
12:L:18:SER:HB2	12:L:173:ALA:H	1.65	0.61
3:Q:136:TYR:HB2	3:Q:148:TYR:HB2	1.82	0.61

*Continued on next page...*

*Continued from previous page...*

Atom-1	Atom-2	Interatomic distance (Å)	Clash overlap (Å)
1:A:120:ASP:OD1	2:B:83:ARG:NH1	2.33	0.61
12:Z:18:SER:HB2	12:Z:173:ALA:H	1.66	0.61
2:B:51:GLN:HB3	2:B:56:TYR:HD2	1.64	0.60
5:E:13:ASN:HB3	6:F:126:ARG:HB3	1.81	0.60
11:Y:29:LYS:HB2	12:Z:121:ILE:HD12	1.83	0.60
2:B:108:GLN:HB3	2:B:112:ARG:HH12	1.66	0.60
9:W:44:CYS:HB2	9:W:99:VAL:HB	1.82	0.60
9:I:63:LEU:HA	9:I:66:HIS:HB3	1.84	0.60
11:K:29:LYS:HD2	12:L:121:ILE:HB	1.82	0.60
9:W:63:LEU:HA	9:W:66:HIS:HB3	1.84	0.60
11:Y:29:LYS:HD2	12:Z:121:ILE:HB	1.82	0.60
13:M:148:LEU:HD23	13:M:178:VAL:HG23	1.84	0.60
10:X:47:ARG:NH2	10:X:191:LYS:O	2.35	0.60
5:S:164:GLN:HB3	6:T:58:ALA:HB3	1.82	0.60
2:B:48:GLU:O	2:B:63:LYS:NZ	2.35	0.59
9:I:81:ARG:HA	9:I:84:LYS:HG2	1.83	0.59
2:P:48:GLU:O	2:P:63:LYS:NZ	2.35	0.59
6:T:76:GLY:HA3	6:T:130:VAL:HA	1.84	0.59
11:K:29:LYS:HB2	12:L:121:ILE:HD12	1.83	0.59
9:I:44:CYS:HB2	9:I:99:VAL:HB	1.82	0.59
4:R:5:ARG:O	4:R:123:GLY:N	2.30	0.59
9:W:81:ARG:HA	9:W:84:LYS:HG2	1.83	0.59
10:J:47:ARG:NH2	10:J:191:LYS:O	2.35	0.59
6:T:49:LEU:HG	6:T:195:LEU:HD11	1.85	0.59
2:P:108:GLN:HB3	2:P:112:ARG:HH12	1.66	0.59
11:Y:85:ARG:HD2	11:Y:124:LEU:HB2	1.85	0.59
12:L:14:VAL:HB	12:L:177:TYR:HB2	1.85	0.58
13:M:169:ASP:HB3	13:M:173:ARG:HH22	1.68	0.58
6:T:39:LYS:HD3	6:T:144:ILE:HG12	1.84	0.58
7:U:79:GLY:HA3	7:U:133:CYS:HA	1.85	0.58
6:F:39:LYS:HD3	6:F:144:ILE:HG12	1.84	0.58
6:F:76:GLY:HA3	6:F:130:VAL:HA	1.84	0.58
11:K:85:ARG:HD2	11:K:124:LEU:HB2	1.85	0.58
13:M:198:VAL:HG22	13:M:203:ILE:HG12	1.86	0.58
5:S:24:VAL:HG13	5:S:158:PRO:HB2	1.84	0.58
2:B:67:ILE:HG21	2:B:109:LEU:HD11	1.85	0.58
3:C:190:LEU:HD23	3:C:236:LEU:HD11	1.86	0.58
6:F:49:LEU:HG	6:F:195:LEU:HD11	1.85	0.58
2:P:67:ILE:HG21	2:P:109:LEU:HD11	1.85	0.58
10:X:14:LYS:HE3	10:X:120:ILE:HG12	1.86	0.58
14:N:33:LEU:HD13	8:V:134:TYR:CZ	2.39	0.58

*Continued on next page...*

*Continued from previous page...*

Atom-1	Atom-2	Interatomic distance (Å)	Clash overlap (Å)
7:G:79:GLY:HA3	7:G:133:CYS:HA	1.85	0.57
5:S:41:GLN:NE2	5:S:151:PRO:O	2.37	0.57
5:E:24:VAL:HG13	5:E:158:PRO:HB2	1.84	0.57
1:A:43:ARG:HA	1:A:48:ALA:HA	1.87	0.57
3:C:133:SER:HB2	3:C:152:PRO:HD3	1.87	0.57
5:E:14:THR:HG23	6:F:21:GLN:HE22	1.70	0.57
13:M:27:THR:HB	13:M:39:ASP:HA	1.86	0.57
6:T:39:LYS:HB3	6:T:144:ILE:HD11	1.87	0.57
10:J:14:LYS:HE3	10:J:120:ILE:HG12	1.86	0.57
1:O:43:ARG:HA	1:O:48:ALA:HA	1.87	0.57
12:Z:14:VAL:HB	12:Z:177:TYR:HB2	1.85	0.57
1:A:34:GLN:NE2	7:G:17:ASP:O	2.38	0.57
2:P:21:ILE:HG21	2:P:151:SER:HB3	1.87	0.57
3:Q:190:LEU:HD23	3:Q:236:LEU:HD11	1.86	0.57
6:F:39:LYS:HB3	6:F:144:ILE:HD11	1.86	0.57
5:E:41:GLN:NE2	5:E:151:PRO:O	2.37	0.57
1:A:141:ILE:HG22	1:A:151:VAL:HG22	1.86	0.57
10:J:125:LEU:HD12	10:J:126:ILE:HG23	1.86	0.56
1:O:34:GLN:NE2	7:U:17:ASP:O	2.38	0.56
3:Q:209:GLU:OE2	3:Q:230:GLN:NE2	2.38	0.56
12:Z:59:LEU:HD22	12:Z:83:LEU:HB2	1.87	0.56
4:D:64:ALA:H	4:D:88:ARG:HH21	1.53	0.56
1:O:141:ILE:HG22	1:O:151:VAL:HG22	1.86	0.56
5:E:41:GLN:N	5:E:166:ASP:O	2.32	0.56
11:K:27:GLN:O	11:Y:170:ARG:NH1	2.34	0.56
10:X:125:LEU:HD12	10:X:126:ILE:HG23	1.86	0.56
5:E:31:ILE:HD13	5:E:140:ALA:HB2	1.87	0.56
5:S:31:ILE:HD13	5:S:140:ALA:HB2	1.88	0.56
8:V:38:HIS:CD2	8:V:39:ASP:H	2.24	0.56
5:S:14:THR:HG23	6:T:21:GLN:HE22	1.70	0.56
2:B:21:ILE:HG21	2:B:151:SER:HB3	1.87	0.56
5:S:41:GLN:N	5:S:166:ASP:O	2.32	0.56
3:C:45:LEU:HD13	3:C:75:SER:HB2	1.88	0.56
3:C:209:GLU:OE2	3:C:230:GLN:NE2	2.38	0.56
4:D:80:ALA:HA	4:D:129:ILE:HD13	1.88	0.56
3:Q:133:SER:HB2	3:Q:152:PRO:HD3	1.87	0.56
12:L:59:LEU:HD22	12:L:83:LEU:HB2	1.87	0.55
6:F:117:GLN:HE22	7:G:83:ASP:HA	1.72	0.55
11:K:170:ARG:NH1	11:Y:27:GLN:O	2.36	0.55
12:L:34:VAL:HG22	12:L:44:THR:HG22	1.89	0.55
8:H:38:HIS:CD2	8:H:39:ASP:H	2.24	0.55

*Continued on next page...*

*Continued from previous page...*

Atom-1	Atom-2	Interatomic distance (Å)	Clash overlap (Å)
3:Q:45:LEU:HD13	3:Q:75:SER:HB2	1.88	0.55
4:R:64:ALA:H	4:R:88:ARG:HH21	1.54	0.55
6:T:117:GLN:HE22	7:U:83:ASP:HA	1.72	0.55
8:V:93:ASP:OD2	9:W:91:GLN:NE2	2.40	0.55
4:D:7:ILE:HG22	4:D:18:GLN:HG3	1.88	0.55
14:N:8:GLY:N	14:N:55:GLY:O	2.38	0.55
12:L:4:LEU:HB3	12:L:15:ALA:HB3	1.89	0.55
12:L:19:ARG:O	12:L:33:LYS:NZ	2.32	0.55
4:R:80:ALA:HA	4:R:129:ILE:HD13	1.88	0.55
8:V:3:ILE:HD12	8:V:99:ILE:HG22	1.89	0.55
9:I:216:ILE:HG12	10:J:195:THR:HG22	1.89	0.54
14:N:189:ILE:HD12	14:N:203:LEU:HD22	1.88	0.54
8:H:93:ASP:OD2	9:I:91:GLN:NE2	2.40	0.54
11:Y:171:PHE:CE2	11:Y:173:LEU:HB2	2.42	0.54
9:I:160:ALA:HA	9:I:163:ILE:HD12	1.90	0.54
11:K:171:PHE:CE2	11:K:173:LEU:HB2	2.42	0.54
12:L:98:GLY:HA2	12:L:115:ASP:HA	1.89	0.54
10:X:9:ALA:HA	10:X:139:GLY:HA3	1.89	0.54
5:E:69:GLU:O	5:E:93:ARG:NE	2.41	0.54
11:K:43:LEU:HD11	11:K:181:ARG:HD2	1.90	0.54
11:Y:43:LEU:HD11	11:Y:181:ARG:HD2	1.90	0.54
12:Z:34:VAL:HG22	12:Z:44:THR:HG22	1.89	0.54
4:D:88:ARG:NH1	11:K:69:MET:O	2.41	0.54
4:R:88:ARG:NH1	11:Y:69:MET:O	2.41	0.54
9:W:216:ILE:HG12	10:X:195:THR:HG22	1.89	0.54
11:Y:39:SER:HB2	11:Y:42:ILE:HG12	1.90	0.54
4:D:69:VAL:HG11	4:D:107:ILE:HG21	1.90	0.54
4:R:7:ILE:HG22	4:R:18:GLN:HG3	1.89	0.54
5:S:100:TRP:O	12:Z:57:ARG:NH2	2.41	0.54
9:W:160:ALA:HA	9:W:163:ILE:HD12	1.90	0.54
10:X:122:SER:HB2	10:X:136:VAL:HB	1.90	0.54
12:Z:4:LEU:HB3	12:Z:15:ALA:HB3	1.89	0.54
8:H:3:ILE:HD12	8:H:99:ILE:HG22	1.89	0.54
4:D:158:ALA:HB3	5:E:58:LEU:HD13	1.90	0.53
10:J:9:ALA:HA	10:J:139:GLY:HA3	1.89	0.53
10:J:143:GLU:HA	10:J:146:TYR:HD2	1.73	0.53
14:N:89:HIS:HE1	14:N:131:ALA:HB1	1.72	0.53
7:G:108:LEU:HD11	7:G:137:LEU:HB3	1.90	0.53
8:H:174:ILE:HB	8:H:189:LEU:HB2	1.91	0.53
10:J:52:LEU:HB2	10:J:59:VAL:HG13	1.91	0.53
6:T:47:VAL:HG12	6:T:195:LEU:HD22	1.90	0.53

*Continued on next page...*

*Continued from previous page...*

Atom-1	Atom-2	Interatomic distance (Å)	Clash overlap (Å)
11:K:39:SER:HB2	11:K:42:ILE:HG12	1.90	0.53
12:L:4:LEU:N	12:L:15:ALA:O	2.40	0.53
5:E:100:TRP:O	12:L:57:ARG:NH2	2.41	0.53
9:I:30:ASN:O	9:I:187:ARG:NH2	2.40	0.53
10:J:122:SER:HB2	10:J:136:VAL:HB	1.90	0.53
5:S:77:ALA:HB3	5:S:142:LEU:HB2	1.90	0.53
10:X:143:GLU:HA	10:X:146:TYR:HD2	1.73	0.53
1:A:125:TYR:HA	1:A:131:MET:HG3	1.90	0.53
11:Y:6:GLY:HA2	11:Y:15:VAL:HA	1.90	0.53
12:Z:98:GLY:HA2	12:Z:115:ASP:HA	1.89	0.53
6:F:143:HIS:HB3	6:F:145:PHE:CD2	2.44	0.53
3:Q:73:ALA:HB2	3:Q:225:ILE:HD13	1.91	0.53
4:R:69:VAL:HG11	4:R:107:ILE:HG21	1.90	0.53
12:Z:4:LEU:N	12:Z:15:ALA:O	2.40	0.53
5:E:77:ALA:HB3	5:E:142:LEU:HB2	1.90	0.53
6:F:82:ARG:HA	6:F:85:CYS:HB3	1.91	0.53
9:W:30:ASN:O	9:W:187:ARG:NH2	2.40	0.53
5:S:69:GLU:O	5:S:93:ARG:NE	2.41	0.53
14:N:28:GLY:N	14:N:36:PHE:O	2.42	0.53
1:O:125:TYR:HA	1:O:131:MET:HG3	1.90	0.53
6:T:11:THR:HA	7:U:129:ARG:HD3	1.91	0.53
10:X:48:LEU:HD21	10:X:86:LEU:HD22	1.90	0.53
6:F:47:VAL:HG12	6:F:195:LEU:HD22	1.90	0.52
10:J:48:LEU:HD21	10:J:86:LEU:HD22	1.90	0.52
11:K:6:GLY:HA2	11:K:15:VAL:HA	1.90	0.52
4:R:116:GLN:O	4:R:119:THR:OG1	2.23	0.52
11:K:98:TYR:HB3	11:K:100:VAL:HG22	1.91	0.52
6:T:143:HIS:HB3	6:T:145:PHE:CD2	2.44	0.52
7:U:108:LEU:HD11	7:U:137:LEU:HB3	1.90	0.52
10:X:52:LEU:HB2	10:X:59:VAL:HG13	1.91	0.52
4:D:116:GLN:O	4:D:119:THR:OG1	2.23	0.52
11:Y:34:LYS:HD3	11:Y:47:VAL:HG12	1.91	0.52
3:Q:124:PHE:HB3	4:R:124:ARG:HG2	1.92	0.52
6:T:7:ASP:HB2	6:T:24:TYR:HE2	1.74	0.52
6:F:7:ASP:HB2	6:F:24:TYR:HE2	1.74	0.52
6:F:33:SER:HB2	6:F:62:LYS:HE2	1.92	0.52
7:G:109:LYS:HA	7:G:149:TYR:HE2	1.75	0.52
4:R:158:ALA:HB3	5:S:58:LEU:HD13	1.90	0.52
13:M:63:THR:HG23	14:N:94:ARG:HH12	1.74	0.52
1:O:192:GLU:OE1	1:O:193:GLN:NE2	2.43	0.52
6:F:11:THR:HA	7:G:129:ARG:HD3	1.91	0.52

*Continued on next page...*



*Continued from previous page...*

Atom-1	Atom-2	Interatomic distance (Å)	Clash overlap (Å)
6:T:33:SER:HB2	6:T:62:LYS:HE2	1.92	0.52
8:V:21:THR:HG22	8:V:26:ILE:HG12	1.92	0.52
8:V:174:ILE:HB	8:V:189:LEU:HB2	1.91	0.52
11:Y:98:TYR:HB3	11:Y:100:VAL:HG22	1.92	0.52
3:C:73:ALA:HB2	3:C:225:ILE:HD13	1.91	0.51
11:K:4:LEU:HD22	11:K:45:LEU:HD23	1.92	0.51
6:T:82:ARG:HA	6:T:85:CYS:HB3	1.91	0.51
9:W:50:ALA:HB2	10:X:128:CYS:HB2	1.93	0.51
1:A:51:VAL:HG22	1:A:217:VAL:HG22	1.92	0.51
2:B:212:CYS:HB2	2:B:217:PHE:HD1	1.75	0.51
8:H:91:ARG:NH1	8:H:92:GLU:OE2	2.43	0.51
7:U:109:LYS:HA	7:U:149:TYR:HE2	1.75	0.51
8:V:127:ILE:HD12	8:V:132:SER:HB2	1.92	0.51
1:A:192:GLU:OE1	1:A:193:GLN:NE2	2.43	0.51
11:K:34:LYS:HD3	11:K:47:VAL:HG12	1.91	0.51
2:B:83:ARG:HA	2:B:86:VAL:HG12	1.93	0.51
13:M:187:VAL:HB	9:W:167:LEU:HB3	1.93	0.51
2:B:183:LEU:HD21	2:B:211:ILE:HD12	1.93	0.51
8:H:37:ILE:HG13	8:H:83:PHE:HZ	1.75	0.51
3:Q:46:ALA:HB1	3:Q:197:LEU:HD11	1.93	0.51
6:T:224:TYR:HD1	6:T:228:ASP:HB3	1.76	0.51
3:C:124:PHE:HB3	4:D:124:ARG:HG2	1.92	0.51
6:F:152:ASN:HB2	7:G:81:LEU:HD23	1.92	0.51
8:H:28:ASN:ND2	9:I:122:LEU:HD11	2.25	0.51
8:V:28:ASN:ND2	9:W:122:LEU:HD11	2.25	0.51
8:V:91:ARG:NH1	8:V:92:GLU:OE2	2.43	0.51
10:X:35:THR:HG22	11:Y:127:ALA:HB2	1.92	0.51
3:C:46:ALA:HB1	3:C:197:LEU:HD11	1.93	0.51
8:H:127:ILE:HD12	8:H:132:SER:HB2	1.92	0.51
1:O:51:VAL:HG22	1:O:217:VAL:HG22	1.92	0.51
9:I:50:ALA:HB2	10:J:128:CYS:HB2	1.92	0.51
4:R:120:GLN:O	5:S:134:SER:N	2.26	0.51
6:T:120:THR:HG22	6:T:127:PRO:HG3	1.92	0.51
8:V:37:ILE:HG13	8:V:83:PHE:HZ	1.75	0.51
3:C:49:ARG:N	3:C:210:LYS:O	2.41	0.51
3:C:158:GLY:HA3	4:D:55:ASP:HB3	1.93	0.51
8:H:133:SER:HA	8:H:136:TYR:HE2	1.76	0.51
6:T:152:ASN:HB2	7:U:81:LEU:HD23	1.92	0.51
11:Y:4:LEU:HD22	11:Y:45:LEU:HD23	1.92	0.51
2:P:183:LEU:HD21	2:P:211:ILE:HD12	1.93	0.51
5:S:98:ASN:OD1	12:Z:61:ARG:NH2	2.44	0.51

*Continued on next page...*

*Continued from previous page...*

Atom-1	Atom-2	Interatomic distance (Å)	Clash overlap (Å)
6:F:224:TYR:HD1	6:F:228:ASP:HB3	1.76	0.50
2:P:212:CYS:HB2	2:P:217:PHE:HD1	1.75	0.50
11:Y:85:ARG:NE	11:Y:122:ALA:O	2.44	0.50
1:A:86:ASP:OD1	7:G:120:HIS:NE2	2.36	0.50
6:F:120:THR:HG22	6:F:127:PRO:HG3	1.92	0.50
4:D:120:GLN:O	5:E:134:SER:N	2.26	0.50
8:H:21:THR:HG22	8:H:26:ILE:HG12	1.93	0.50
11:K:168:GLN:NE2	11:K:175:LEU:O	2.45	0.50
8:V:28:ASN:HD21	9:W:122:LEU:HD11	1.77	0.50
10:X:24:ASP:OD1	10:X:40:LYS:NZ	2.34	0.50
4:D:116:GLN:NE2	5:E:83:ALA:O	2.45	0.50
5:E:98:ASN:OD1	12:L:61:ARG:NH2	2.44	0.50
11:K:85:ARG:NE	11:K:122:ALA:O	2.44	0.50
9:W:209:THR:OG1	10:X:168:GLN:NE2	2.38	0.50
3:Q:158:GLY:HA3	4:R:55:ASP:HB3	1.93	0.50
8:H:28:ASN:HD21	9:I:122:LEU:HD11	1.77	0.50
4:R:116:GLN:NE2	5:S:83:ALA:O	2.45	0.50
11:Y:81:ALA:HA	11:Y:104:LEU:HD13	1.94	0.50
14:N:37:ARG:HD2	14:N:184:TYR:CE1	2.47	0.50
6:T:189:LYS:HB3	6:T:193:ARG:HH12	1.77	0.50
8:V:133:SER:HA	8:V:136:TYR:HE2	1.76	0.50
6:F:45:VAL:HG22	6:F:214:ILE:HG12	1.94	0.50
11:K:43:LEU:HD12	11:K:183:ILE:HD11	1.94	0.50
2:P:83:ARG:HA	2:P:86:VAL:HG12	1.93	0.50
10:J:35:THR:HG22	11:K:127:ALA:HB2	1.92	0.50
11:K:81:ALA:HA	11:K:104:LEU:HD13	1.94	0.50
7:G:71:ARG:NH2	7:G:105:ASN:OD1	2.45	0.49
10:J:152:LEU:HB3	10:J:165:THR:HG23	1.95	0.49
12:L:8:PHE:CE1	12:L:10:HIS:HB2	2.47	0.49
12:L:138:VAL:HG21	12:L:162:GLN:HG3	1.94	0.49
13:M:194:ARG:HH11	13:M:207:THR:HB	1.77	0.49
12:Z:21:THR:HG22	12:Z:26:ILE:HG12	1.95	0.49
12:Z:164:THR:HG22	12:Z:170:SER:HB3	1.94	0.49
1:A:49:VAL:HG22	1:A:219:VAL:HG12	1.94	0.49
6:T:45:VAL:HG22	6:T:214:ILE:HG12	1.94	0.49
9:W:13:VAL:HG22	9:W:177:VAL:HG22	1.94	0.49
9:I:13:VAL:HG22	9:I:177:VAL:HG22	1.94	0.49
12:L:21:THR:HG22	12:L:26:ILE:HG12	1.95	0.49
13:M:36:HIS:HB3	14:N:132:TYR:CZ	2.48	0.49
9:I:209:THR:OG1	10:J:168:GLN:NE2	2.38	0.49
12:L:45:MET:HG3	12:L:52:CYS:HB2	1.95	0.49

*Continued on next page...*

*Continued from previous page...*

Atom-1	Atom-2	Interatomic distance (Å)	Clash overlap (Å)
10:X:152:LEU:HB3	10:X:165:THR:HG23	1.95	0.49
12:Z:45:MET:HG3	12:Z:52:CYS:HB2	1.95	0.49
11:Y:168:GLN:NE2	11:Y:175:LEU:O	2.45	0.49
12:Z:8:PHE:CE1	12:Z:10:HIS:HB2	2.48	0.49
6:F:6:TYR:OH	7:G:8:ASP:OD2	2.27	0.49
11:K:59:TYR:HE2	11:K:87:ASN:HD22	1.60	0.49
14:N:53:ALA:HB2	14:N:110:MET:HG2	1.95	0.49
1:O:103:TYR:O	9:W:81:ARG:HD3	2.13	0.49
9:W:97:ALA:HB1	9:W:127:MET:HE1	1.94	0.49
12:L:164:THR:HG22	12:L:170:SER:HB3	1.95	0.49
6:T:192:LEU:HD21	6:T:212:ILE:HD11	1.95	0.49
7:U:71:ARG:NH2	7:U:105:ASN:OD1	2.45	0.49
1:A:103:TYR:O	9:I:81:ARG:HD3	2.13	0.49
14:N:27:LEU:HA	14:N:37:ARG:HA	1.95	0.49
6:F:189:LYS:HB3	6:F:193:ARG:HH12	1.77	0.48
11:K:45:LEU:HD22	11:K:103:LEU:HD23	1.95	0.48
3:Q:3:ARG:NH1	5:S:125:GLU:OE2	2.46	0.48
11:Y:43:LEU:HD12	11:Y:183:ILE:HD11	1.94	0.48
12:Z:33:LYS:O	12:Z:45:MET:N	2.41	0.48
1:A:50:ILE:HD12	1:A:79:VAL:HB	1.96	0.48
3:Q:49:ARG:N	3:Q:210:LYS:O	2.41	0.48
9:W:59:ILE:HD12	9:W:82:MET:HB3	1.95	0.48
11:Y:45:LEU:HD22	11:Y:103:LEU:HD23	1.95	0.48
6:F:195:LEU:O	6:F:198:THR:OG1	2.26	0.48
9:I:18:THR:HG21	9:I:187:ARG:HH12	1.77	0.48
1:O:49:VAL:HG22	1:O:219:VAL:HG12	1.94	0.48
12:Z:138:VAL:HG21	12:Z:162:GLN:HG3	1.94	0.48
2:B:49:LYS:H	2:B:207:ILE:HA	1.79	0.48
3:C:109:GLN:HE21	11:K:71:ASN:HD21	1.62	0.48
11:K:45:LEU:O	11:K:103:LEU:N	2.45	0.48
6:T:6:TYR:OH	7:U:8:ASP:OD2	2.27	0.48
4:D:5:ARG:HA	5:E:125:GLU:HB2	1.96	0.48
6:F:192:LEU:HD21	6:F:212:ILE:HD11	1.95	0.48
8:V:176:LEU:HD12	8:V:187:GLN:HE21	1.78	0.48
3:C:3:ARG:NH1	5:E:125:GLU:OE2	2.46	0.48
7:G:73:VAL:HG22	7:G:139:SER:HB3	1.95	0.48
7:G:149:TYR:HD1	7:G:159:GLY:HA2	1.79	0.48
8:H:176:LEU:HD12	8:H:187:GLN:HE21	1.78	0.48
11:K:19:ARG:NE	11:K:177:THR:HB	2.28	0.48
4:R:5:ARG:HA	5:S:125:GLU:HB2	1.96	0.48
6:T:26:MET:HA	6:T:149:PRO:HG2	1.96	0.48

*Continued on next page...*

*Continued from previous page...*

Atom-1	Atom-2	Interatomic distance (Å)	Clash overlap (Å)
14:N:15:LYS:HE3	14:N:135:PRO:HA	1.96	0.48
14:N:25:ASP:OD1	14:N:41:ARG:NH2	2.47	0.48
2:P:49:LYS:H	2:P:207:ILE:HA	1.79	0.48
2:B:38:LYS:HE3	2:B:158:LYS:HA	1.96	0.48
7:U:73:VAL:HG22	7:U:139:SER:HB3	1.95	0.48
9:W:18:THR:HG21	9:W:187:ARG:HH12	1.78	0.48
9:I:12:ILE:HD11	9:I:110:LEU:HD12	1.96	0.47
1:O:50:ILE:HD12	1:O:79:VAL:HB	1.95	0.47
14:N:144:TYR:HB3	9:W:132:LEU:HB3	1.96	0.47
2:P:38:LYS:HE3	2:P:158:LYS:HA	1.96	0.47
7:U:149:TYR:HD1	7:U:159:GLY:HA2	1.79	0.47
11:Y:19:ARG:NE	11:Y:177:THR:HB	2.28	0.47
4:D:87:ALA:HB1	4:D:107:ILE:HD11	1.96	0.47
6:F:26:MET:HA	6:F:149:PRO:HG2	1.96	0.47
5:E:49:ALA:HB1	5:E:202:LEU:HD11	1.97	0.47
9:W:12:ILE:HD11	9:W:110:LEU:HD12	1.96	0.47
4:D:83:VAL:HG21	4:D:129:ILE:HD11	1.97	0.47
11:K:19:ARG:HE	11:K:177:THR:HB	1.80	0.47
5:S:49:ALA:HB1	5:S:202:LEU:HD11	1.97	0.47
2:B:88:ARG:HD2	2:B:116:VAL:HG11	1.96	0.47
9:I:59:ILE:HD12	9:I:82:MET:HB3	1.95	0.47
11:K:29:LYS:HD3	11:K:32:HIS:HD2	1.80	0.47
13:M:113:LEU:HD13	13:M:198:VAL:HG12	1.96	0.47
14:N:10:SER:OG	14:N:142:GLY:N	2.48	0.47
14:N:45:VAL:HG11	14:N:88:ILE:HD13	1.96	0.47
2:P:73:LEU:HD13	2:P:133:LEU:HD22	1.97	0.47
4:R:83:VAL:HG21	4:R:129:ILE:HD11	1.97	0.47
11:Y:59:TYR:HE2	11:Y:87:ASN:HD22	1.61	0.47
2:P:51:GLN:HB3	2:P:56:TYR:CD2	2.49	0.47
3:C:161:ALA:HB1	3:C:175:LEU:HD13	1.97	0.47
3:Q:161:ALA:HB1	3:Q:175:LEU:HD13	1.97	0.47
4:R:87:ALA:HB1	4:R:107:ILE:HD11	1.96	0.47
11:Y:19:ARG:HE	11:Y:177:THR:HB	1.80	0.47
11:Y:29:LYS:HD3	11:Y:32:HIS:HD2	1.80	0.47
4:D:91:CYS:HA	4:D:102:VAL:HG11	1.96	0.47
14:N:184:TYR:HE2	14:N:186:ARG:HB2	1.79	0.47
3:Q:109:GLN:HE21	11:Y:71:ASN:HD21	1.62	0.47
6:T:117:GLN:O	6:T:120:THR:OG1	2.24	0.47
10:X:55:LEU:HD11	11:Y:121:LEU:HD13	1.97	0.47
12:Z:40:TYR:CD2	12:Z:73:ARG:HD3	2.50	0.47
9:I:97:ALA:HB1	9:I:127:MET:HE1	1.96	0.46

*Continued on next page...*

*Continued from previous page...*

Atom-1	Atom-2	Interatomic distance (Å)	Clash overlap (Å)
6:T:117:GLN:NE2	7:U:83:ASP:HA	2.31	0.46
11:Y:20:VAL:O	11:Y:34:LYS:NZ	2.48	0.46
12:L:158:ARG:HD3	11:Y:145:ARG:HD3	1.97	0.46
13:M:28:ARG:NH1	13:M:187:VAL:O	2.49	0.46
5:S:182:GLN:HA	6:T:56:LEU:HD11	1.98	0.46
10:X:58:ASP:OD2	10:X:103:TYR:N	2.35	0.46
12:Z:97:MET:CG	12:Z:98:GLY:H	2.25	0.46
5:E:182:GLN:HA	6:F:56:LEU:HD11	1.98	0.46
10:J:178:ALA:HB1	12:Z:168:ALA:HB1	1.97	0.46
14:N:124:TYR:HE1	14:N:139:THR:HG22	1.79	0.46
4:R:168:VAL:HG13	4:R:194:ALA:HB1	1.98	0.46
14:N:25:ASP:HA	14:N:187:PHE:HA	1.96	0.46
2:B:73:LEU:HD22	2:B:135:ILE:HG12	1.98	0.46
10:J:101:PRO:O	11:K:93:ARG:NH2	2.49	0.46
12:L:4:LEU:HB2	12:L:160:ILE:HD11	1.97	0.46
12:L:40:TYR:CD2	12:L:73:ARG:HD3	2.51	0.46
4:R:92:GLN:HG3	11:Y:66:LEU:HB2	1.97	0.46
2:B:8:SER:HA	2:B:124:GLY:HA2	1.97	0.46
10:J:55:LEU:HD11	11:K:121:LEU:HD13	1.97	0.46
12:L:97:MET:CG	12:L:98:GLY:H	2.25	0.46
12:L:127:SER:O	12:L:136:TYR:OH	2.23	0.46
13:M:183:ALA:HA	13:M:189:THR:HG23	1.97	0.46
10:X:66:LEU:HD21	10:X:86:LEU:HD11	1.97	0.46
1:A:72:ILE:HA	1:A:95:ARG:HG2	1.98	0.46
6:F:70:ILE:HG12	6:F:105:VAL:HG22	1.98	0.46
7:G:98:PHE:HE1	8:H:66:HIS:HE1	1.63	0.46
10:J:19:VAL:HG23	10:J:189:ILE:HD12	1.98	0.46
11:K:12:TYR:OH	11:K:151:ILE:HG23	2.16	0.46
1:O:152:TYR:CD1	1:O:162:GLY:HA2	2.51	0.46
2:P:88:ARG:HD2	2:P:116:VAL:HG11	1.96	0.46
11:Y:88:LEU:HG	11:Y:122:ALA:HB2	1.98	0.46
1:A:152:TYR:CD1	1:A:162:GLY:HA2	2.51	0.46
11:K:20:VAL:O	11:K:34:LYS:NZ	2.48	0.46
11:K:174:ASN:N	11:Y:172:ILE:O	2.41	0.46
4:R:91:CYS:HA	4:R:102:VAL:HG11	1.97	0.46
7:U:219:LEU:HD12	7:U:220:THR:HG23	1.97	0.46
10:X:101:PRO:O	11:Y:93:ARG:NH2	2.49	0.46
2:B:73:LEU:HD13	2:B:133:LEU:HD22	1.97	0.46
7:G:185:THR:O	7:G:189:ILE:HG12	2.16	0.46
14:N:42:ILE:HD12	14:N:188:GLN:HB2	1.97	0.46
2:P:120:TYR:HD1	2:P:126:VAL:HG21	1.81	0.46

*Continued on next page...*

*Continued from previous page...*

Atom-1	Atom-2	Interatomic distance (Å)	Clash overlap (Å)
6:F:65:HIS:O	6:F:89:ARG:NE	2.49	0.46
1:O:14:THR:HG22	1:O:24:GLN:HB3	1.98	0.46
2:P:73:LEU:HD22	2:P:135:ILE:HG12	1.98	0.46
5:S:22:PHE:HA	5:S:25:GLU:HB3	1.98	0.46
12:Z:4:LEU:HB2	12:Z:160:ILE:HD11	1.96	0.46
12:Z:127:SER:O	12:Z:136:TYR:OH	2.23	0.46
2:B:51:GLN:HB3	2:B:56:TYR:CD2	2.49	0.45
4:D:92:GLN:HG3	11:K:66:LEU:HB2	1.97	0.45
6:F:117:GLN:NE2	7:G:83:ASP:HA	2.31	0.45
11:Y:12:TYR:HB2	11:Y:182:ILE:HD11	1.98	0.45
12:Z:179:VAL:HG22	12:Z:184:TRP:HB3	1.99	0.45
9:I:202:TYR:HD2	10:J:151:SER:HB3	1.81	0.45
5:E:22:PHE:HA	5:E:25:GLU:HB3	1.98	0.45
13:M:29:LEU:HG	13:M:36:HIS:CD2	2.51	0.45
1:A:14:THR:HG22	1:A:24:GLN:HB3	1.98	0.45
2:B:133:LEU:HB2	2:B:148:SER:HB3	1.99	0.45
7:G:219:LEU:HD12	7:G:220:THR:HG23	1.97	0.45
13:M:57:PHE:HZ	14:N:128:LEU:HB3	1.80	0.45
2:P:8:SER:HA	2:P:124:GLY:HA2	1.97	0.45
5:S:73:HIS:CE1	5:S:106:THR:HB	2.52	0.45
1:A:22:LEU:HD13	1:A:25:VAL:HG21	1.98	0.45
11:K:88:LEU:HG	11:K:122:ALA:HB2	1.98	0.45
2:P:133:LEU:HB2	2:P:148:SER:HB3	1.99	0.45
9:W:202:TYR:HD2	10:X:151:SER:HB3	1.81	0.45
11:Y:45:LEU:O	11:Y:103:LEU:N	2.44	0.45
11:Y:117:TYR:N	11:Y:125:ALA:O	2.49	0.45
2:B:118:GLN:NE2	3:C:82:ASP:HA	2.32	0.45
5:E:73:HIS:CE1	5:E:106:THR:HB	2.52	0.45
10:J:66:LEU:HD21	10:J:86:LEU:HD11	1.97	0.45
7:U:98:PHE:HE1	8:V:66:HIS:HE1	1.63	0.45
5:E:41:GLN:HB3	5:E:166:ASP:HA	1.99	0.45
10:J:14:LYS:HA	10:J:19:VAL:HG12	1.98	0.45
11:K:167:LEU:O	11:K:171:PHE:HB3	2.16	0.45
14:N:12:LEU:HD21	14:N:176:LEU:HD11	1.99	0.45
1:O:22:LEU:HD13	1:O:25:VAL:HG21	1.98	0.45
4:R:31:THR:OG1	4:R:163:ARG:O	2.31	0.45
6:T:69:HIS:CD2	6:T:70:ILE:HG13	2.52	0.45
10:X:14:LYS:HA	10:X:19:VAL:HG12	1.98	0.45
10:X:19:VAL:HG23	10:X:189:ILE:HD12	1.98	0.45
11:Y:9:GLY:HA3	11:Y:12:TYR:CZ	2.52	0.45
5:E:160:GLY:HA3	6:F:79:ALA:HB2	1.99	0.45

*Continued on next page...*

*Continued from previous page...*

Atom-1	Atom-2	Interatomic distance (Å)	Clash overlap (Å)
11:K:9:GLY:HA3	11:K:12:TYR:CZ	2.52	0.45
12:L:33:LYS:O	12:L:45:MET:N	2.41	0.45
2:P:118:GLN:NE2	3:Q:82:ASP:HA	2.32	0.45
6:T:47:VAL:HG22	6:T:212:ILE:HG12	1.99	0.45
6:T:65:HIS:O	6:T:89:ARG:NE	2.49	0.45
7:U:185:THR:O	7:U:189:ILE:HG12	2.16	0.45
11:Y:167:LEU:O	11:Y:171:PHE:HB3	2.16	0.45
2:B:120:TYR:HD1	2:B:126:VAL:HG21	1.81	0.45
4:D:168:VAL:HG13	4:D:194:ALA:HB1	1.98	0.45
13:M:68:ILE:HD11	13:M:92:LEU:HD13	1.97	0.45
1:O:72:ILE:HA	1:O:95:ARG:HG2	1.98	0.45
1:O:86:ASP:OD1	7:U:120:HIS:NE2	2.36	0.45
11:K:117:TYR:N	11:K:125:ALA:O	2.49	0.45
8:V:1:THR:HG21	8:V:46:SER:HA	1.99	0.45
11:Y:77:PRO:HD2	11:Y:108:ASP:HB2	1.99	0.45
4:D:140:GLY:O	4:D:213:ARG:CZ	2.64	0.44
10:J:57:THR:O	11:K:85:ARG:NH2	2.51	0.44
14:N:27:LEU:HD13	14:N:184:TYR:HB2	1.98	0.44
4:R:88:ARG:HH11	11:Y:70:ARG:HA	1.82	0.44
5:S:160:GLY:HA3	6:T:79:ALA:HB2	1.99	0.44
6:T:70:ILE:HG12	6:T:105:VAL:HG22	1.98	0.44
9:W:83:LEU:HB2	9:W:113:ILE:HD13	1.99	0.44
4:D:88:ARG:HH11	11:K:70:ARG:HA	1.82	0.44
6:F:69:HIS:CD2	6:F:70:ILE:HG13	2.52	0.44
2:P:124:GLY:H	3:Q:127:LYS:HE3	1.82	0.44
6:T:10:VAL:HB	6:T:21:GLN:HG2	1.99	0.44
6:F:192:LEU:HD13	6:F:233:LEU:HD23	2.00	0.44
5:S:41:GLN:HA	5:S:46:VAL:HG12	1.99	0.44
6:T:195:LEU:O	6:T:198:THR:OG1	2.25	0.44
11:K:12:TYR:HB2	11:K:182:ILE:HD11	1.98	0.44
5:S:41:GLN:HB3	5:S:166:ASP:HA	1.99	0.44
6:T:192:LEU:HD13	6:T:233:LEU:HD23	2.00	0.44
3:C:172:VAL:O	3:C:176:LYS:HG3	2.18	0.44
5:E:195:ILE:HG22	5:E:237:VAL:HG11	2.00	0.44
12:L:179:VAL:HG22	12:L:184:TRP:HB3	1.99	0.44
3:Q:172:VAL:O	3:Q:176:LYS:HG3	2.18	0.44
10:X:55:LEU:HG	10:X:57:THR:HG22	2.00	0.44
10:X:57:THR:O	11:Y:85:ARG:NH2	2.51	0.44
11:Y:12:TYR:OH	11:Y:151:ILE:HG23	2.16	0.44
1:A:158:GLY:O	2:B:83:ARG:NH2	2.51	0.44
12:L:5:ALA:HA	12:L:13:ILE:O	2.18	0.44

*Continued on next page...*

*Continued from previous page...*

Atom-1	Atom-2	Interatomic distance (Å)	Clash overlap (Å)
5:S:195:ILE:HG22	5:S:237:VAL:HG11	2.00	0.44
6:F:47:VAL:HG22	6:F:212:ILE:HG12	1.99	0.44
10:J:58:ASP:OD2	10:J:103:TYR:N	2.35	0.44
13:M:11:THR:HG21	13:M:141:ALA:HB3	2.00	0.44
2:P:70:HIS:CD2	2:P:71:ILE:HG13	2.53	0.44
5:S:59:MET:SD	5:S:64:ILE:HD11	2.58	0.44
7:U:215:TRP:HE1	7:U:219:LEU:HD11	1.83	0.44
11:Y:156:ALA:O	11:Y:160:LEU:N	2.42	0.44
5:E:41:GLN:HA	5:E:46:VAL:HG12	1.99	0.44
9:I:8:TYR:CE2	9:I:13:VAL:HG23	2.53	0.44
3:Q:60:PHE:O	3:Q:62:SER:N	2.50	0.44
3:C:60:PHE:O	3:C:62:SER:N	2.50	0.44
5:E:59:MET:SD	5:E:64:ILE:HD11	2.58	0.44
6:F:45:VAL:HG11	6:F:188:VAL:HG22	2.00	0.44
5:S:27:ALA:HB1	5:S:138:GLY:HA2	2.00	0.44
10:X:67:LYS:HE3	10:X:71:ASN:HD21	1.83	0.44
7:G:119:VAL:HG13	7:G:131:PHE:HD2	1.82	0.43
10:J:25:ARG:HB3	10:J:36:THR:O	2.18	0.43
7:U:119:VAL:HG13	7:U:131:PHE:HD2	1.82	0.43
9:W:8:TYR:CE2	9:W:13:VAL:HG23	2.53	0.43
7:G:215:TRP:HE1	7:G:219:LEU:HD11	1.83	0.43
14:N:25:ASP:O	14:N:41:ARG:NH2	2.50	0.43
8:V:142:THR:HG23	8:V:155:PHE:HE1	1.84	0.43
9:W:174:ASP:OD1	9:W:187:ARG:NH1	2.51	0.43
12:Z:103:GLY:HA2	12:Z:179:VAL:HG11	2.00	0.43
1:O:158:GLY:O	2:P:83:ARG:NH2	2.51	0.43
6:T:45:VAL:HG11	6:T:188:VAL:HG22	2.00	0.43
12:Z:5:ALA:HA	12:Z:13:ILE:O	2.18	0.43
12:Z:8:PHE:HE1	12:Z:10:HIS:HB2	1.83	0.43
2:B:124:GLY:H	3:C:127:LYS:HE3	1.82	0.43
8:H:142:THR:HG23	8:H:155:PHE:HE1	1.84	0.43
9:I:163:ILE:HD13	9:I:192:PRO:HG2	2.00	0.43
5:S:141:LEU:HB2	5:S:156:MET:HE2	2.01	0.43
8:H:1:THR:HG21	8:H:46:SER:HA	1.99	0.43
12:L:8:PHE:HE1	12:L:10:HIS:HB2	1.83	0.43
13:M:57:PHE:CZ	14:N:128:LEU:HB3	2.53	0.43
14:N:72:ILE:O	14:N:76:LEU:HG	2.18	0.43
9:W:43:CYS:SG	9:W:98:LEU:HB3	2.58	0.43
9:W:163:ILE:HD13	9:W:192:PRO:HG2	2.01	0.43
4:D:31:THR:OG1	4:D:163:ARG:O	2.31	0.43
5:E:41:GLN:NE2	5:E:152:GLN:HA	2.33	0.43

*Continued on next page...*



*Continued from previous page...*

Atom-1	Atom-2	Interatomic distance (Å)	Clash overlap (Å)
12:L:58:LEU:HD12	12:L:61:ARG:HD3	2.01	0.43
4:R:140:GLY:O	4:R:213:ARG:CZ	2.65	0.43
10:X:25:ARG:HB3	10:X:36:THR:O	2.18	0.43
10:X:117:LYS:HD2	10:X:118:PRO:HD2	2.01	0.43
12:Z:167:ASP:HB3	12:Z:170:SER:HB2	2.01	0.43
9:I:43:CYS:SG	9:I:98:LEU:HB3	2.58	0.43
13:M:29:LEU:HG	13:M:36:HIS:HD2	1.83	0.43
13:M:169:ASP:HB3	13:M:173:ARG:NH2	2.31	0.43
4:R:45:VAL:HG11	4:R:61:LYS:HB2	2.01	0.43
2:B:70:HIS:CD2	2:B:71:ILE:HG13	2.53	0.43
9:I:83:LEU:HB2	9:I:113:ILE:HD13	1.99	0.43
10:J:55:LEU:HG	10:J:57:THR:HG22	2.00	0.43
11:K:29:LYS:HE3	11:K:32:HIS:HA	2.01	0.43
12:L:100:MET:HB3	12:L:111:LEU:HD11	2.00	0.43
7:U:215:TRP:HZ3	7:U:227:VAL:HG13	1.84	0.43
9:W:112:SER:HB3	9:W:125:VAL:HG21	2.00	0.43
7:G:68:ASN:OD1	7:G:224:HIS:ND1	2.52	0.43
11:K:77:PRO:HD2	11:K:108:ASP:HB2	1.99	0.43
10:X:6:ASN:ND2	10:X:28:GLY:O	2.44	0.43
1:A:132:ARG:HD3	7:G:12:SER:HA	2.01	0.43
7:G:215:TRP:HZ3	7:G:227:VAL:HG13	1.84	0.43
9:I:112:SER:HB3	9:I:125:VAL:HG21	2.00	0.43
9:I:122:LEU:HD22	9:I:125:VAL:HG12	2.00	0.43
6:T:39:LYS:HB2	6:T:142:PRO:HB2	2.01	0.43
8:V:19:ARG:NH1	8:V:168:GLY:O	2.46	0.43
9:W:126:THR:OG1	9:W:135:MET:SD	2.72	0.43
12:Z:58:LEU:HD12	12:Z:61:ARG:HD3	2.01	0.43
3:C:171:ALA:HB2	3:C:200:THR:HG21	2.01	0.42
9:I:19:ARG:NH1	9:I:167:LEU:O	2.51	0.42
10:J:117:LYS:HD2	10:J:118:PRO:HD2	2.01	0.42
12:L:3:THR:OG1	12:L:128:VAL:HB	2.19	0.42
3:C:214:ALA:HB2	3:C:227:VAL:HG22	2.00	0.42
3:Q:214:ALA:HB2	3:Q:227:VAL:HG22	2.00	0.42
5:S:69:GLU:HG2	5:S:226:PHE:CD2	2.55	0.42
2:B:38:LYS:HG3	2:B:43:VAL:HG22	2.01	0.42
5:E:27:ALA:HB1	5:E:138:GLY:HA2	2.00	0.42
6:F:10:VAL:HB	6:F:21:GLN:HG2	1.99	0.42
6:F:47:VAL:HG11	6:F:192:LEU:HD23	2.01	0.42
10:J:67:LYS:HE3	10:J:71:ASN:HD21	1.83	0.42
14:N:166:ARG:NH2	14:N:200:GLU:OE1	2.43	0.42
2:P:38:LYS:HG3	2:P:43:VAL:HG22	2.01	0.42

*Continued on next page...*

*Continued from previous page...*

Atom-1	Atom-2	Interatomic distance (Å)	Clash overlap (Å)
12:Z:100:MET:HB3	12:Z:111:LEU:HD11	2.00	0.42
2:B:108:GLN:HE22	10:J:76:LYS:HG2	1.85	0.42
4:D:64:ALA:O	4:D:88:ARG:NE	2.53	0.42
11:K:42:ILE:HG22	11:K:106:GLY:HA3	2.02	0.42
11:K:47:VAL:O	11:K:101:ASN:N	2.41	0.42
13:M:185:ARG:HA	9:W:26:VAL:HB	2.02	0.42
1:O:159:TYR:CZ	1:O:161:CYS:HB3	2.55	0.42
3:Q:119:GLN:HE22	4:R:79:ASP:HA	1.84	0.42
5:S:41:GLN:NE2	5:S:152:GLN:HA	2.33	0.42
9:W:19:ARG:NH1	9:W:167:LEU:O	2.51	0.42
2:B:121:THR:HG22	2:B:128:PRO:HB3	2.02	0.42
3:C:86:LEU:HD22	3:C:114:LEU:HD11	2.01	0.42
9:I:174:ASP:OD1	9:I:187:ARG:NH1	2.51	0.42
12:L:103:GLY:HA2	12:L:179:VAL:HG11	2.00	0.42
14:N:187:PHE:HE1	14:N:189:ILE:HD11	1.85	0.42
1:O:132:ARG:HD3	7:U:12:SER:HA	2.01	0.42
9:W:122:LEU:HD22	9:W:125:VAL:HG12	2.00	0.42
5:E:141:LEU:HB2	5:E:156:MET:HE2	2.01	0.42
10:J:121:CYS:SG	10:J:122:SER:N	2.92	0.42
13:M:27:THR:O	13:M:40:SER:N	2.53	0.42
6:T:95:SER:O	6:T:99:PHE:N	2.47	0.42
10:X:121:CYS:SG	10:X:122:SER:N	2.92	0.42
12:Z:3:THR:OG1	12:Z:128:VAL:HB	2.19	0.42
6:F:39:LYS:HB2	6:F:142:PRO:HB2	2.01	0.42
10:J:12:ALA:HA	10:J:21:ILE:HA	2.01	0.42
13:M:4:PRO:O	14:N:100:ARG:NH1	2.41	0.42
7:U:21:PHE:HB3	7:U:25:TYR:CE2	2.55	0.42
11:Y:13:VAL:HG11	11:Y:106:GLY:N	2.35	0.42
4:D:115:LYS:NZ	4:D:147:THR:OG1	2.42	0.42
5:E:69:GLU:HG2	5:E:226:PHE:CD2	2.55	0.42
5:E:110:GLU:HA	5:E:154:PHE:HE2	1.85	0.42
10:J:142:ALA:HB1	10:J:146:TYR:HE2	1.85	0.42
10:J:148:MET:HE3	10:J:152:LEU:HD11	2.01	0.42
14:N:56:ASP:N	14:N:107:TRP:HD1	2.17	0.42
11:Y:14:LEU:HD12	11:Y:182:ILE:HD13	2.01	0.42
2:P:121:THR:HG22	2:P:128:PRO:HB3	2.01	0.42
3:Q:86:LEU:HD22	3:Q:114:LEU:HD11	2.01	0.42
9:W:187:ARG:CB	9:W:188:PRO:CD	2.86	0.42
11:Y:29:LYS:HE3	11:Y:32:HIS:HA	2.01	0.42
1:A:191:PHE:H	1:A:194:THR:HG23	1.85	0.42
14:N:92:LEU:HD21	14:N:110:MET:SD	2.60	0.42

*Continued on next page...*

*Continued from previous page...*

Atom-1	Atom-2	Interatomic distance (Å)	Clash overlap (Å)
11:Y:29:LYS:HD3	11:Y:32:HIS:CD2	2.55	0.42
12:Z:40:TYR:OH	12:Z:74:ILE:HG22	2.20	0.42
11:K:29:LYS:HD3	11:K:32:HIS:CD2	2.55	0.41
2:P:108:GLN:HE22	10:X:76:LYS:HG2	1.85	0.41
3:Q:122:THR:HG22	3:Q:129:PRO:HB3	2.02	0.41
5:S:68:VAL:HB	5:S:93:ARG:HH21	1.85	0.41
5:S:73:HIS:CD2	5:S:74:ILE:HG13	2.55	0.41
10:X:142:ALA:HB1	10:X:146:TYR:HE2	1.85	0.41
10:X:148:MET:HE3	10:X:152:LEU:HD11	2.01	0.41
11:Y:42:ILE:HG22	11:Y:106:GLY:HA3	2.02	0.41
1:A:159:TYR:CZ	1:A:161:CYS:HB3	2.55	0.41
12:L:167:ASP:HB3	12:L:170:SER:HB2	2.01	0.41
2:P:72:GLY:HA3	2:P:217:PHE:CE2	2.55	0.41
3:Q:171:ALA:HB2	3:Q:200:THR:HG21	2.01	0.41
6:T:47:VAL:HG11	6:T:192:LEU:HD23	2.01	0.41
10:X:110:GLY:HA2	10:X:189:ILE:HD13	2.02	0.41
5:E:73:HIS:CD2	5:E:74:ILE:HG13	2.55	0.41
8:H:99:ILE:HA	8:H:113:SER:HA	2.02	0.41
11:K:6:GLY:HA3	11:K:15:VAL:HG12	2.02	0.41
7:U:68:ASN:OD1	7:U:224:HIS:ND1	2.52	0.41
9:W:18:THR:OG1	9:W:172:ASN:HB2	2.20	0.41
11:Y:6:GLY:HA3	11:Y:15:VAL:HG12	2.02	0.41
11:Y:9:GLY:HA3	11:Y:12:TYR:CE2	2.56	0.41
4:D:45:VAL:HG11	4:D:61:LYS:HB2	2.01	0.41
4:D:65:LEU:HD22	4:D:87:ALA:HB3	2.02	0.41
8:H:133:SER:HA	8:H:136:TYR:CE2	2.55	0.41
9:I:8:TYR:HE2	9:I:13:VAL:HG23	1.86	0.41
9:I:18:THR:OG1	9:I:172:ASN:HB2	2.20	0.41
11:K:9:GLY:HA3	11:K:12:TYR:CE2	2.55	0.41
12:L:179:VAL:HA	12:L:184:TRP:HA	2.03	0.41
13:M:36:HIS:HB3	14:N:132:TYR:CE2	2.55	0.41
13:M:166:LEU:HD11	13:M:171:ALA:HB2	2.02	0.41
1:A:122:SER:HA	1:A:125:TYR:HD2	1.86	0.41
3:C:119:GLN:HE22	4:D:79:ASP:HA	1.84	0.41
9:I:1:THR:HG21	9:I:46:ALA:HA	2.03	0.41
11:K:14:LEU:HD12	11:K:182:ILE:HD13	2.01	0.41
11:K:29:LYS:HE3	11:K:31:ASP:O	2.21	0.41
4:R:64:ALA:O	4:R:88:ARG:NE	2.53	0.41
2:B:72:GLY:HA3	2:B:217:PHE:CE2	2.55	0.41
5:E:68:VAL:HB	5:E:93:ARG:HH21	1.85	0.41
6:F:144:ILE:O	6:F:144:ILE:HG22	2.20	0.41

*Continued on next page...*

*Continued from previous page...*

Atom-1	Atom-2	Interatomic distance (Å)	Clash overlap (Å)
7:G:21:PHE:HB3	7:G:25:TYR:CE2	2.55	0.41
7:G:45:VAL:HG13	7:G:148:LEU:HD12	2.02	0.41
12:L:40:TYR:OH	12:L:74:ILE:HG22	2.20	0.41
12:L:91:LYS:NZ	12:L:117:GLU:O	2.52	0.41
7:U:47:PHE:HZ	7:U:138:GLY:HA3	1.86	0.41
11:Y:47:VAL:O	11:Y:101:ASN:N	2.41	0.41
7:G:131:PHE:O	7:G:153:PRO:HB3	2.21	0.41
11:K:173:LEU:HD23	11:Y:173:LEU:HD23	2.02	0.41
2:P:10:THR:HG22	2:P:18:LEU:HD22	2.02	0.41
6:T:103:LEU:HD23	6:T:104:PRO:O	2.21	0.41
8:V:133:SER:HA	8:V:136:TYR:CE2	2.55	0.41
11:K:13:VAL:HG11	11:K:106:GLY:N	2.35	0.41
13:M:108:ASN:HB2	13:M:124:PHE:HB2	2.01	0.41
11:Y:129:PHE:HB2	11:Y:143:LEU:HD13	2.03	0.41
1:A:69:LEU:HD13	1:A:216:GLU:HG3	2.03	0.41
1:A:152:TYR:HD1	1:A:162:GLY:HA2	1.86	0.41
4:D:66:ASP:OD1	4:D:67:ASP:N	2.50	0.41
5:E:68:VAL:HB	5:E:93:ARG:NH2	2.36	0.41
7:G:69:VAL:HA	7:G:92:ARG:HG2	2.03	0.41
8:H:19:ARG:NH1	8:H:168:GLY:O	2.46	0.41
11:K:38:MET:HB2	11:K:42:ILE:HG13	2.03	0.41
12:L:41:LEU:HD21	12:L:101:ILE:HG23	2.03	0.41
13:M:49:LYS:HD2	13:M:113:LEU:HB2	2.02	0.41
14:N:67:LEU:HD11	14:N:88:ILE:HG23	2.02	0.41
1:O:191:PHE:H	1:O:194:THR:HG23	1.85	0.41
4:R:65:LEU:HD22	4:R:87:ALA:HB3	2.02	0.41
5:S:42:THR:OG1	5:S:45:GLY:O	2.30	0.41
5:S:110:GLU:HA	5:S:154:PHE:HE2	1.85	0.41
7:U:88:ALA:O	7:U:92:ARG:HG3	2.21	0.41
10:X:12:ALA:HA	10:X:21:ILE:HA	2.01	0.41
12:Z:41:LEU:HD21	12:Z:101:ILE:HG23	2.03	0.41
10:J:110:GLY:HA2	10:J:189:ILE:HD13	2.02	0.41
11:K:129:PHE:HB2	11:K:143:LEU:HD13	2.03	0.41
12:L:180:ARG:HH21	12:L:185:ILE:HG21	1.86	0.41
13:M:85:THR:HG21	13:M:120:ALA:HB3	2.02	0.41
2:P:32:ALA:HA	2:P:33:PRO:HD3	1.98	0.41
3:C:53:HIS:HB3	3:C:56:LEU:HG	2.04	0.40
7:G:88:ALA:O	7:G:92:ARG:HG3	2.21	0.40
3:Q:123:GLN:HG3	4:R:125:ARG:HG2	2.02	0.40
6:T:144:ILE:HG22	6:T:144:ILE:O	2.20	0.40
9:W:8:TYR:HE2	9:W:13:VAL:HG23	1.86	0.40

*Continued on next page...*

Continued from previous page...

Atom-1	Atom-2	Interatomic distance (Å)	Clash overlap (Å)
11:Y:108:ASP:HB3	11:Y:111:GLU:HB3	2.03	0.40
12:Z:179:VAL:HA	12:Z:184:TRP:HA	2.03	0.40
3:C:122:THR:HG22	3:C:129:PRO:HB3	2.02	0.40
5:E:166:ASP:HB3	5:E:185:TYR:CZ	2.56	0.40
13:M:185:ARG:HG2	9:W:29:LYS:NZ	2.36	0.40
9:W:112:SER:HB3	9:W:125:VAL:HG11	2.03	0.40
11:Y:29:LYS:HE3	11:Y:31:ASP:O	2.21	0.40
7:G:47:PHE:HZ	7:G:138:GLY:HA3	1.86	0.40
7:G:215:TRP:CE3	7:G:227:VAL:HG22	2.56	0.40
1:O:152:TYR:HD1	1:O:162:GLY:HA2	1.86	0.40
11:Y:38:MET:HB2	11:Y:42:ILE:HG13	2.03	0.40
11:Y:92:LEU:HD12	11:Y:93:ARG:HG3	2.03	0.40
1:A:72:ILE:HG21	1:A:114:LEU:HD21	2.03	0.40
2:B:10:THR:HG22	2:B:18:LEU:HD22	2.02	0.40
7:G:39:ILE:HD12	7:G:193:VAL:HG22	2.04	0.40
9:W:1:THR:HG21	9:W:46:ALA:HA	2.03	0.40
3:C:123:GLN:HG3	4:D:125:ARG:HG2	2.02	0.40
6:F:95:SER:O	6:F:99:PHE:N	2.47	0.40
10:J:29:ILE:HG22	10:J:30:GLN:N	2.32	0.40
11:K:108:ASP:HB3	11:K:111:GLU:HB3	2.03	0.40
13:M:55:SER:OG	13:M:107:TYR:HB2	2.22	0.40
3:Q:53:HIS:HB3	3:Q:56:LEU:HG	2.04	0.40
5:S:166:ASP:HB3	5:S:185:TYR:CZ	2.56	0.40
6:T:35:THR:HG22	6:T:48:ALA:HB1	2.04	0.40
7:U:69:VAL:HA	7:U:92:ARG:HG2	2.03	0.40
7:U:87:LEU:HD13	7:U:135:PHE:CE2	2.57	0.40
7:U:131:PHE:O	7:U:153:PRO:HB3	2.21	0.40
8:V:7:GLN:HB2	8:V:111:VAL:HG23	2.04	0.40

There are no symmetry-related clashes.

## 5.3 Torsion angles [\(i\)](#)

### 5.3.1 Protein backbone [\(i\)](#)

In the following table, the Percentiles column shows the percent Ramachandran outliers of the chain as a percentile score with respect to all PDB entries followed by that with respect to all EM entries.

The Analysed column shows the number of residues for which the backbone conformation was analysed, and the total number of residues.

Mol	Chain	Analysed	Favoured	Allowed	Outliers	Percentiles	
1	A	238/246 (97%)	229 (96%)	8 (3%)	1 (0%)	34	71
1	O	238/246 (97%)	227 (95%)	11 (5%)	0	100	100
2	B	227/234 (97%)	222 (98%)	5 (2%)	0	100	100
2	P	227/234 (97%)	222 (98%)	5 (2%)	0	100	100
3	C	245/261 (94%)	231 (94%)	14 (6%)	0	100	100
3	Q	245/261 (94%)	231 (94%)	14 (6%)	0	100	100
4	D	230/248 (93%)	223 (97%)	6 (3%)	1 (0%)	34	71
4	R	230/248 (93%)	223 (97%)	6 (3%)	1 (0%)	34	71
5	E	231/241 (96%)	225 (97%)	6 (3%)	0	100	100
5	S	231/241 (96%)	225 (97%)	6 (3%)	0	100	100
6	F	231/263 (88%)	227 (98%)	3 (1%)	1 (0%)	34	71
6	T	231/263 (88%)	227 (98%)	3 (1%)	1 (0%)	34	71
7	G	237/255 (93%)	232 (98%)	5 (2%)	0	100	100
7	U	237/255 (93%)	232 (98%)	5 (2%)	0	100	100
8	H	200/205 (98%)	197 (98%)	3 (2%)	0	100	100
8	V	200/205 (98%)	197 (98%)	3 (2%)	0	100	100
9	I	218/234 (93%)	205 (94%)	13 (6%)	0	100	100
9	W	218/234 (93%)	205 (94%)	13 (6%)	0	100	100
10	J	202/205 (98%)	194 (96%)	8 (4%)	0	100	100
10	X	202/205 (98%)	194 (96%)	8 (4%)	0	100	100
11	K	194/201 (96%)	189 (97%)	5 (3%)	0	100	100
11	Y	194/201 (96%)	189 (97%)	5 (3%)	0	100	100
12	L	198/204 (97%)	195 (98%)	3 (2%)	0	100	100
12	Z	198/204 (97%)	195 (98%)	3 (2%)	0	100	100
13	M	210/213 (99%)	203 (97%)	7 (3%)	0	100	100
13	a	210/213 (99%)	203 (97%)	7 (3%)	0	100	100
14	N	210/219 (96%)	206 (98%)	4 (2%)	0	100	100
14	b	210/219 (96%)	206 (98%)	4 (2%)	0	100	100
All	All	6142/6458 (95%)	5954 (97%)	183 (3%)	5 (0%)	54	84

All (5) Ramachandran outliers are listed below:

Mol	Chain	Res	Type
1	A	184	LYS
4	D	216	SER
4	R	216	SER
6	F	59	HIS
6	T	59	HIS

### 5.3.2 Protein sidechains [i](#)

In the following table, the Percentiles column shows the percent sidechain outliers of the chain as a percentile score with respect to all PDB entries followed by that with respect to all EM entries.

The Analysed column shows the number of residues for which the sidechain conformation was analysed, and the total number of residues.

Mol	Chain	Analysed	Rotameric	Outliers	Percentiles	
1	A	163/210 (78%)	163 (100%)	0	100	100
1	O	163/210 (78%)	163 (100%)	0	100	100
2	B	150/191 (78%)	150 (100%)	0	100	100
2	P	150/191 (78%)	150 (100%)	0	100	100
3	C	160/221 (72%)	160 (100%)	0	100	100
3	Q	160/221 (72%)	160 (100%)	0	100	100
4	D	136/211 (64%)	136 (100%)	0	100	100
4	R	136/211 (64%)	136 (100%)	0	100	100
5	E	158/203 (78%)	158 (100%)	0	100	100
5	S	158/203 (78%)	158 (100%)	0	100	100
6	F	160/224 (71%)	160 (100%)	0	100	100
6	T	160/224 (71%)	160 (100%)	0	100	100
7	G	162/212 (76%)	162 (100%)	0	100	100
7	U	162/212 (76%)	162 (100%)	0	100	100
8	H	140/159 (88%)	140 (100%)	0	100	100
8	V	140/159 (88%)	140 (100%)	0	100	100
9	I	157/195 (80%)	157 (100%)	0	100	100
9	W	157/195 (80%)	157 (100%)	0	100	100
10	J	155/174 (89%)	155 (100%)	0	100	100
10	X	155/174 (89%)	155 (100%)	0	100	100

*Continued on next page...*

*Continued from previous page...*

Mol	Chain	Analysed	Rotameric	Outliers	Percentiles	
11	K	148/171 (86%)	148 (100%)	0	100	100
11	Y	148/171 (86%)	148 (100%)	0	100	100
12	L	138/159 (87%)	138 (100%)	0	100	100
12	Z	138/159 (87%)	138 (100%)	0	100	100
13	M	158/178 (89%)	158 (100%)	0	100	100
13	a	158/178 (89%)	158 (100%)	0	100	100
14	N	149/181 (82%)	149 (100%)	0	100	100
14	b	149/181 (82%)	149 (100%)	0	100	100
All	All	4268/5378 (79%)	4268 (100%)	0	100	100

There are no protein residues with a non-rotameric sidechain to report.

Sometimes sidechains can be flipped to improve hydrogen bonding and reduce clashes. All (55) such sidechains are listed below:

Mol	Chain	Res	Type
1	A	24	GLN
1	A	128	ASN
1	A	193	GLN
2	B	51	GLN
2	B	87	HIS
2	B	108	GLN
3	C	40	ASN
3	C	109	GLN
3	C	167	ASN
3	C	198	ASN
4	D	154	HIS
5	E	97	GLN
6	F	43	HIS
6	F	60	GLN
8	H	7	GLN
8	H	38	HIS
8	H	187	GLN
9	I	66	HIS
10	J	92	ASN
10	J	168	GLN
11	K	63	ASN
11	K	65	GLN
11	K	101	ASN
13	M	36	HIS

*Continued on next page...*



*Continued from previous page...*

Mol	Chain	Res	Type
13	M	108	ASN
13	M	157	ASN
14	N	69	GLN
14	N	81	HIS
1	O	24	GLN
1	O	128	ASN
1	O	193	GLN
2	P	51	GLN
2	P	87	HIS
2	P	108	GLN
3	Q	40	ASN
3	Q	109	GLN
3	Q	119	GLN
3	Q	167	ASN
3	Q	198	ASN
5	S	97	GLN
6	T	43	HIS
6	T	60	GLN
8	V	7	GLN
8	V	38	HIS
8	V	187	GLN
9	W	66	HIS
10	X	92	ASN
10	X	168	GLN
11	Y	63	ASN
11	Y	65	GLN
11	Y	101	ASN
13	a	36	HIS
13	a	108	ASN
14	b	69	GLN
14	b	81	HIS

### 5.3.3 RNA [i](#)

There are no RNA molecules in this entry.

### 5.4 Non-standard residues in protein, DNA, RNA chains [i](#)

There are no non-standard protein/DNA/RNA residues in this entry.

## 5.5 Carbohydrates [i](#)

There are no monosaccharides in this entry.

## 5.6 Ligand geometry [i](#)

There are no ligands in this entry.

## 5.7 Other polymers [i](#)

There are no such residues in this entry.

## 5.8 Polymer linkage issues [i](#)

There are no chain breaks in this entry.

## 6 Map visualisation [i](#)

This section contains visualisations of the EMDB entry EMD-31727. These allow visual inspection of the internal detail of the map and identification of artifacts.

No raw map or half-maps were deposited for this entry and therefore no images, graphs, etc. pertaining to the raw map can be shown.

### 6.1 Orthogonal projections [i](#)

#### 6.1.1 Primary map

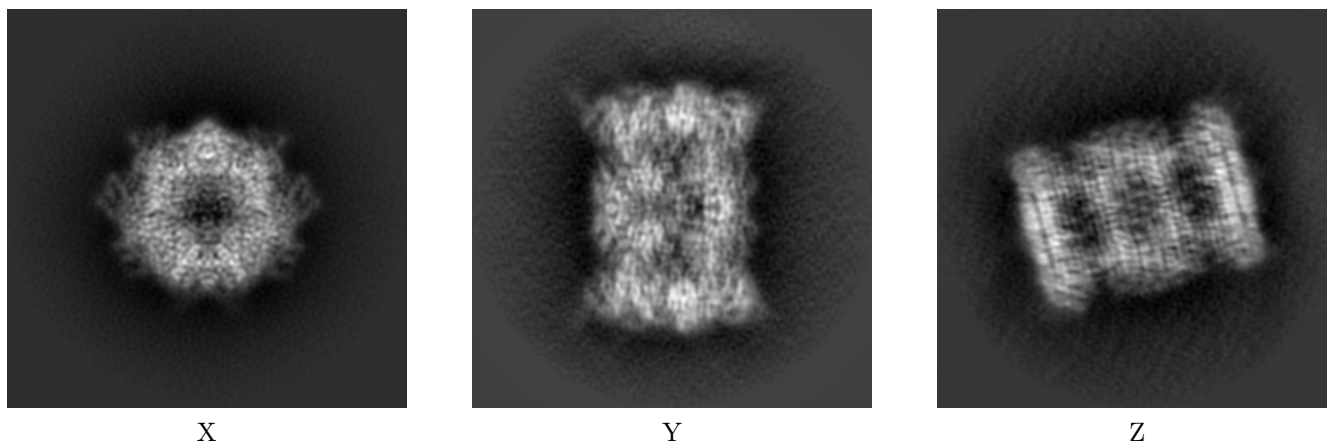

The images above show the map projected in three orthogonal directions.

### 6.2 Central slices [i](#)

#### 6.2.1 Primary map

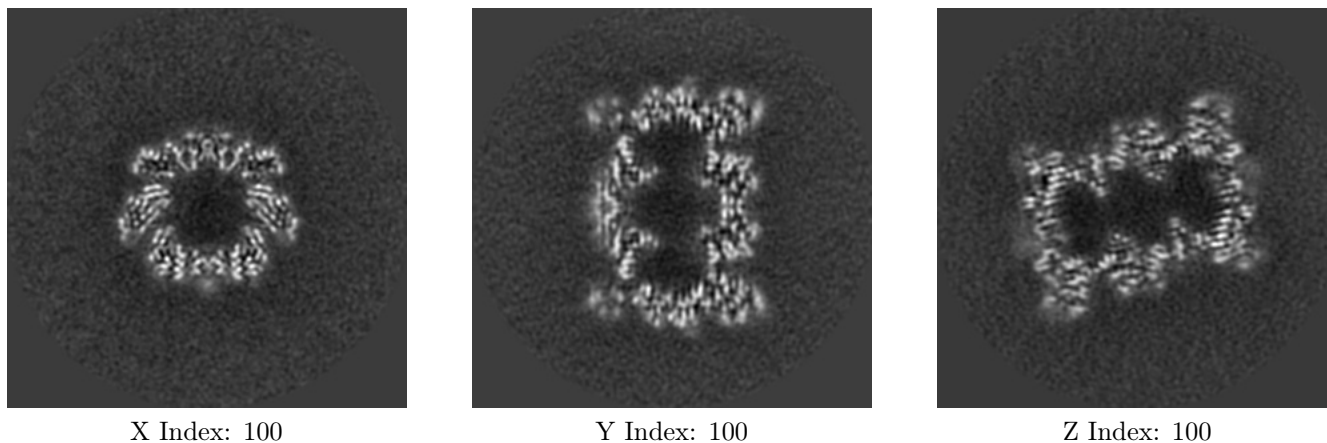

The images above show central slices of the map in three orthogonal directions.

## 6.3 Largest variance slices [i](#)

### 6.3.1 Primary map

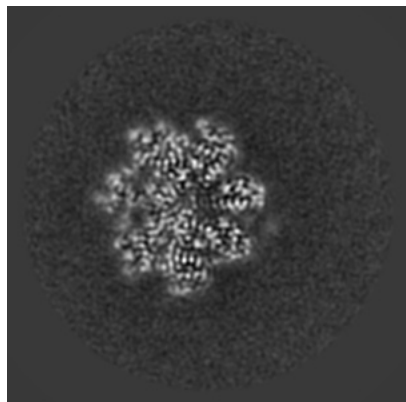

X Index: 59

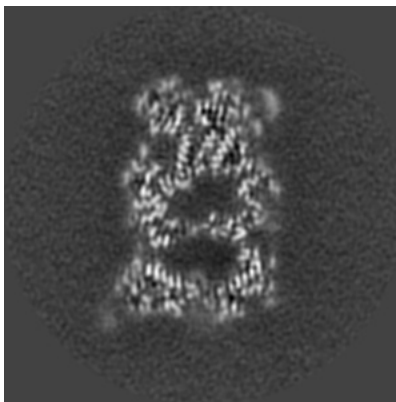

Y Index: 86

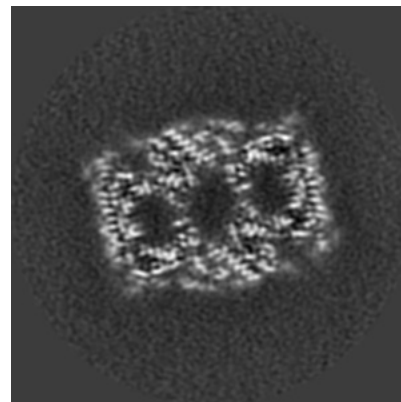

Z Index: 87

The images above show the largest variance slices of the map in three orthogonal directions.

## 6.4 Orthogonal standard-deviation projections (False-color) [i](#)

### 6.4.1 Primary map

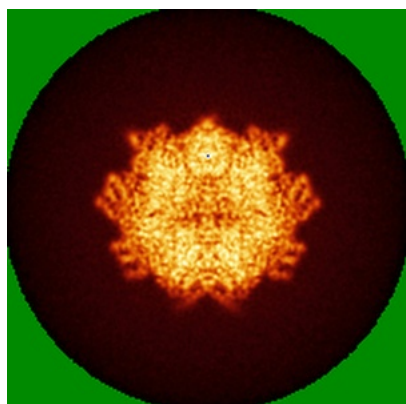

X

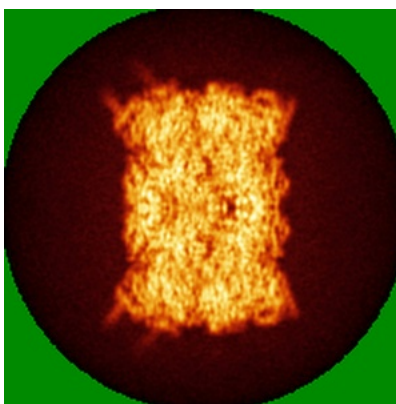

Y

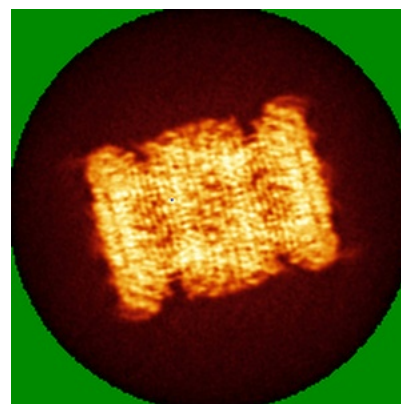

Z

The images above show the map standard deviation projections with false color in three orthogonal directions. Minimum values are shown in green, max in blue, and dark to light orange shades represent small to large values respectively.

## 6.5 Orthogonal surface views [i](#)

### 6.5.1 Primary map

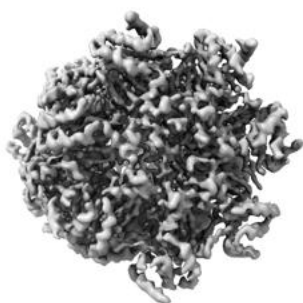

X

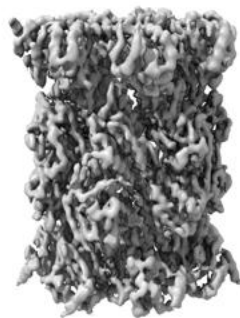

Y

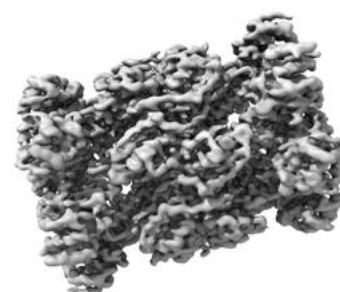

Z

The images above show the 3D surface view of the map at the recommended contour level 0.0135. These images, in conjunction with the slice images, may facilitate assessment of whether an appropriate contour level has been provided.

## 6.6 Mask visualisation [i](#)

This section was not generated. No masks/segmentation were deposited.

## 7 Map analysis [i](#)

This section contains the results of statistical analysis of the map.

### 7.1 Map-value distribution [i](#)

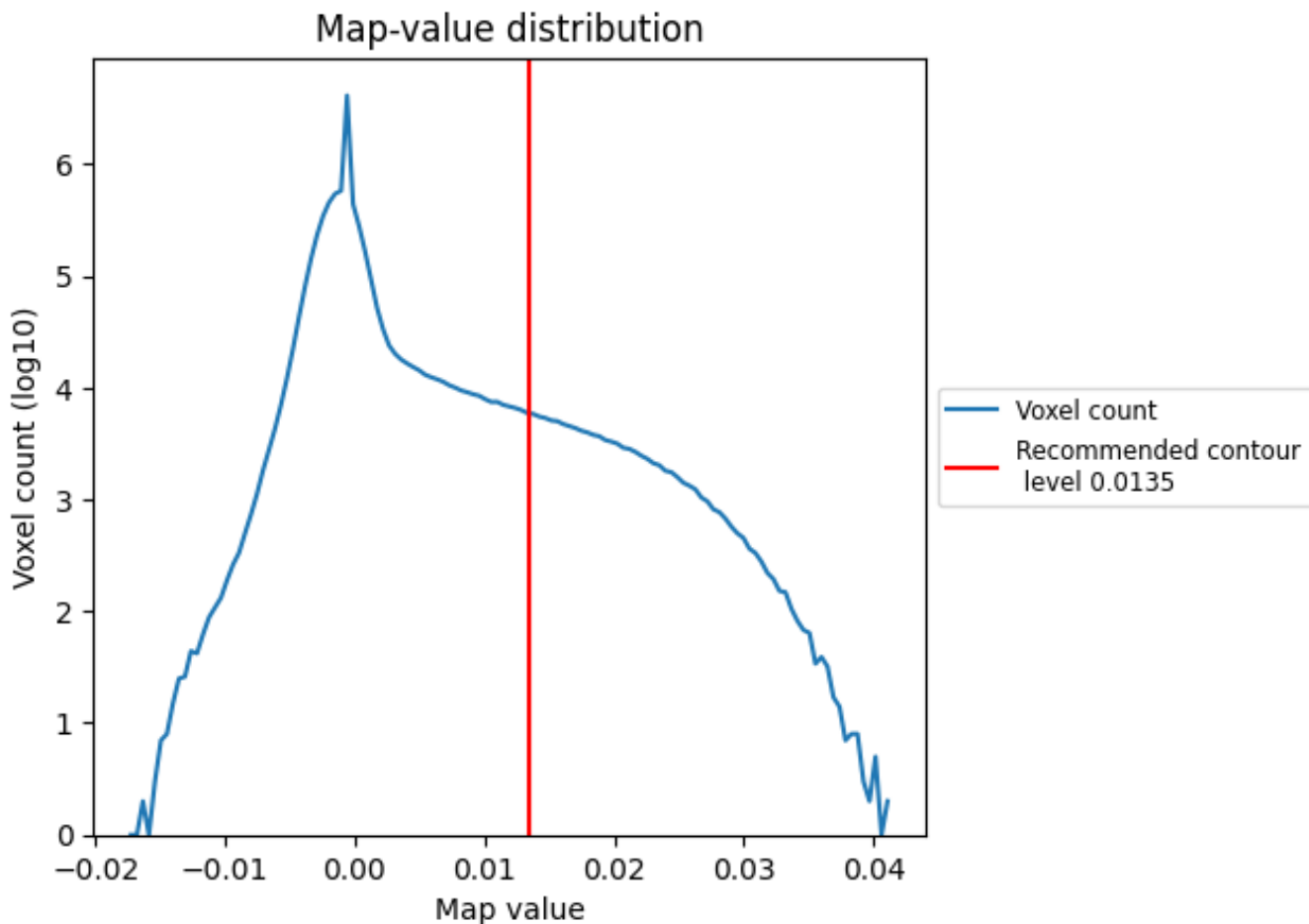

The map-value distribution is plotted in 128 intervals along the x-axis. The y-axis is logarithmic. A spike in this graph at zero usually indicates that the volume has been masked.

## 7.2 Volume estimate [i](#)

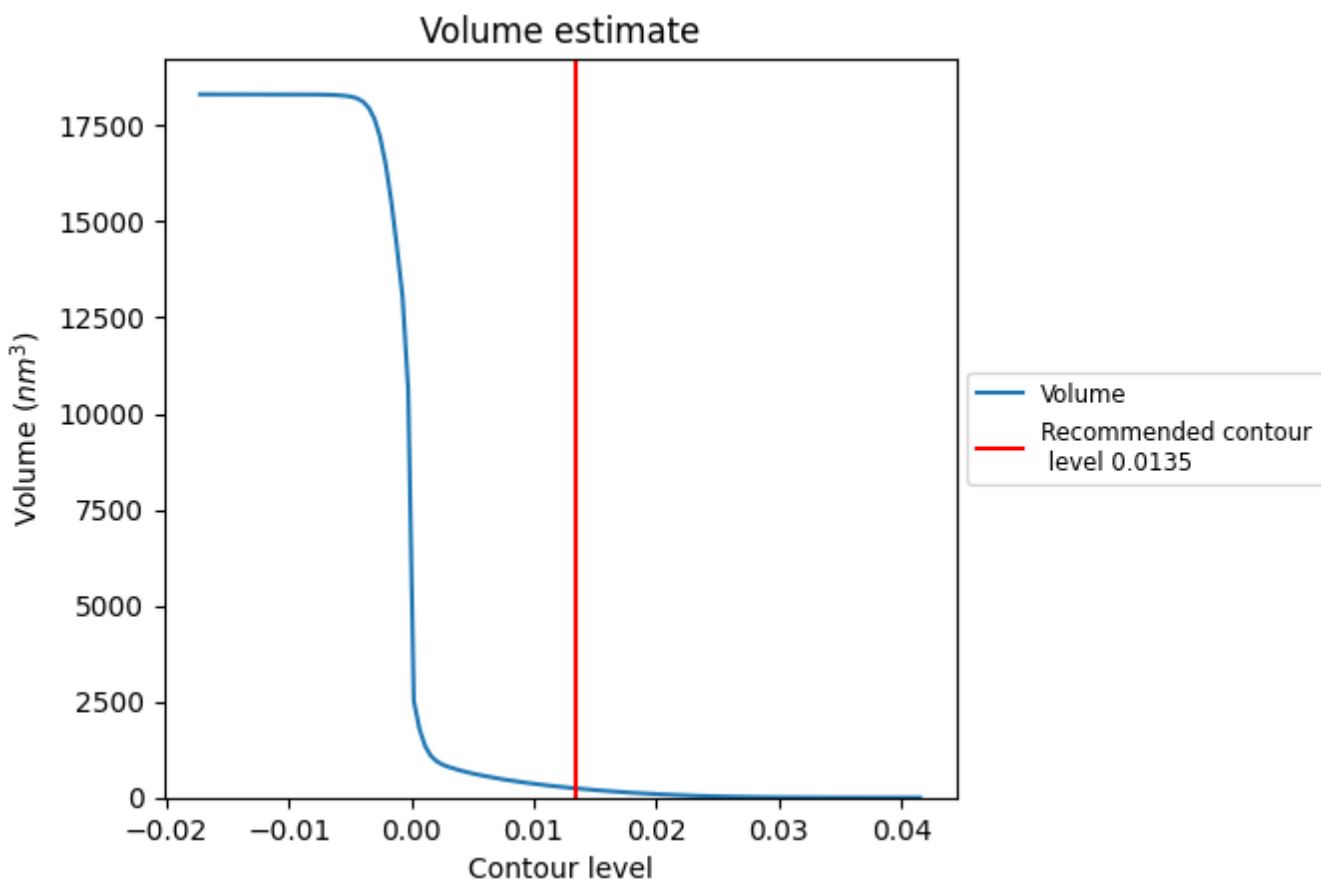

The volume at the recommended contour level is 237 nm<sup>3</sup>; this corresponds to an approximate mass of 214 kDa.

The volume estimate graph shows how the enclosed volume varies with the contour level. The recommended contour level is shown as a vertical line and the intersection between the line and the curve gives the volume of the enclosed surface at the given level.

### 7.3 Rotationally averaged power spectrum [i](#)

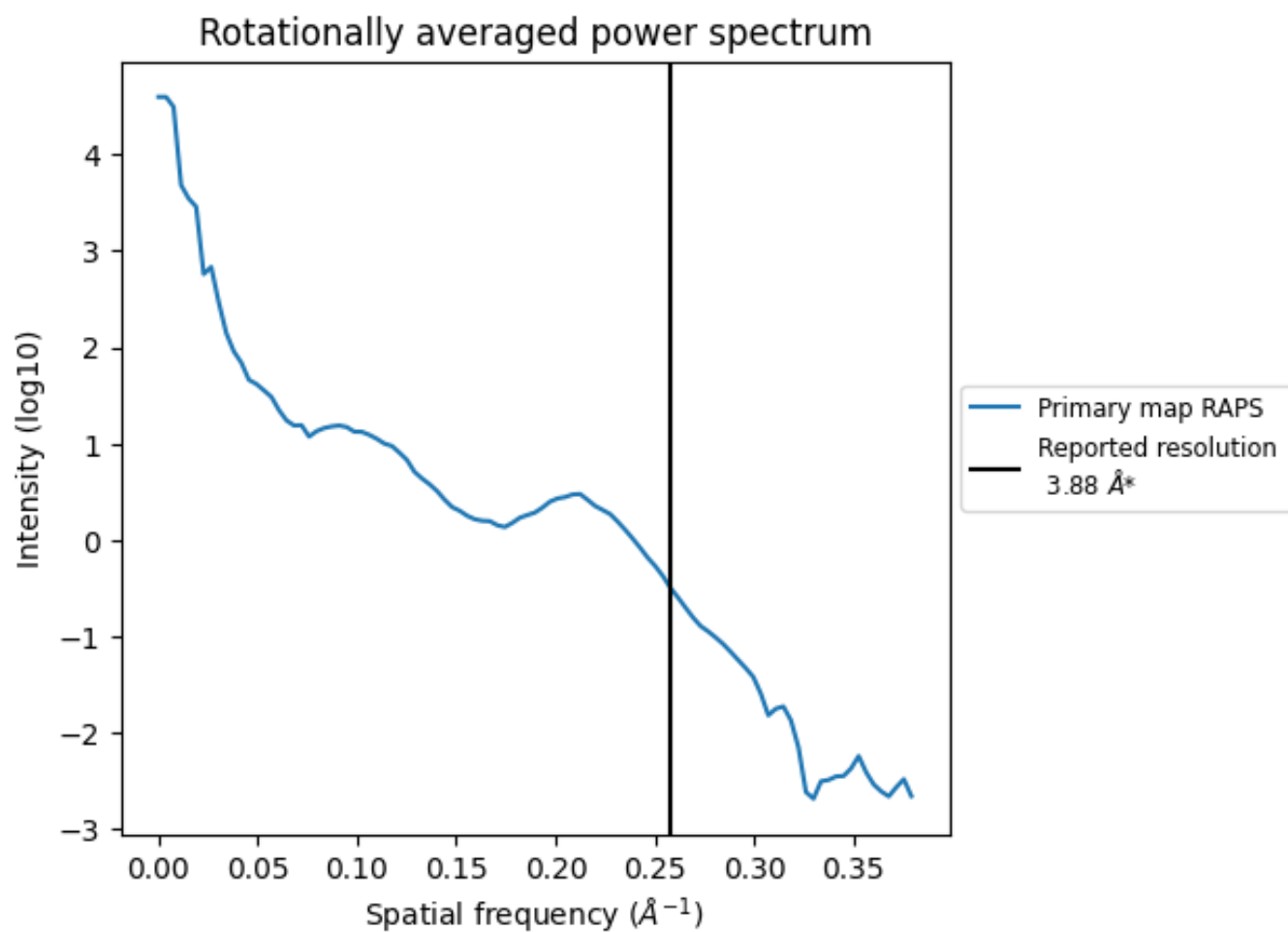

\*Reported resolution corresponds to spatial frequency of 0.258 Å<sup>-1</sup>



## 8 Fourier-Shell correlation

This section was not generated. No FSC curve or half-maps provided.

## 9 Map-model fit [i](#)

This section contains information regarding the fit between EMDB map EMD-31727 and PDB model 7V5M. Per-residue inclusion information can be found in section 3 on page 7.

### 9.1 Map-model overlay [i](#)

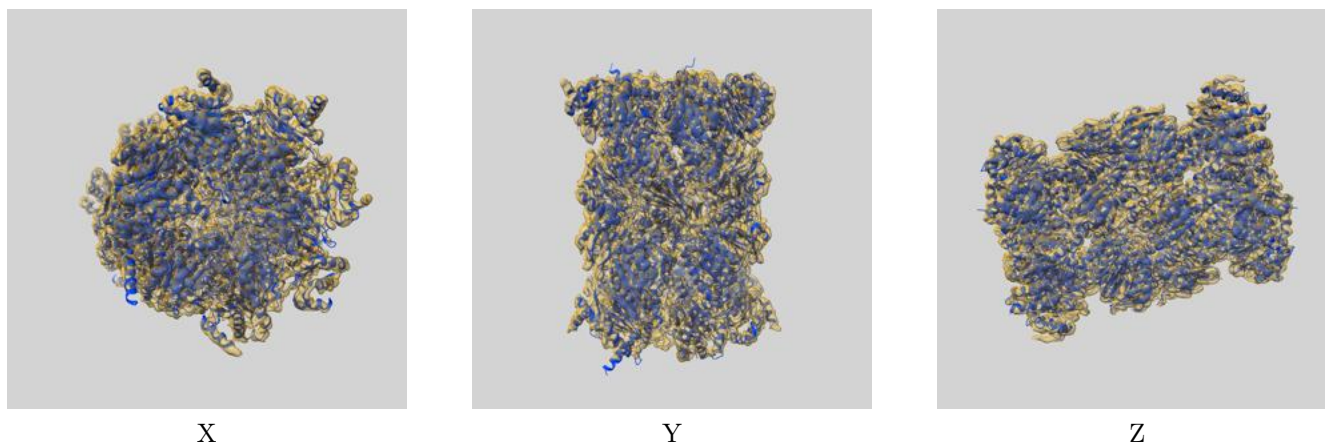

The images above show the 3D surface view of the map at the recommended contour level 0.0135 at 50% transparency in yellow overlaid with a ribbon representation of the model coloured in blue. These images allow for the visual assessment of the quality of fit between the atomic model and the map.

## 9.2 Q-score mapped to coordinate model [i](#)

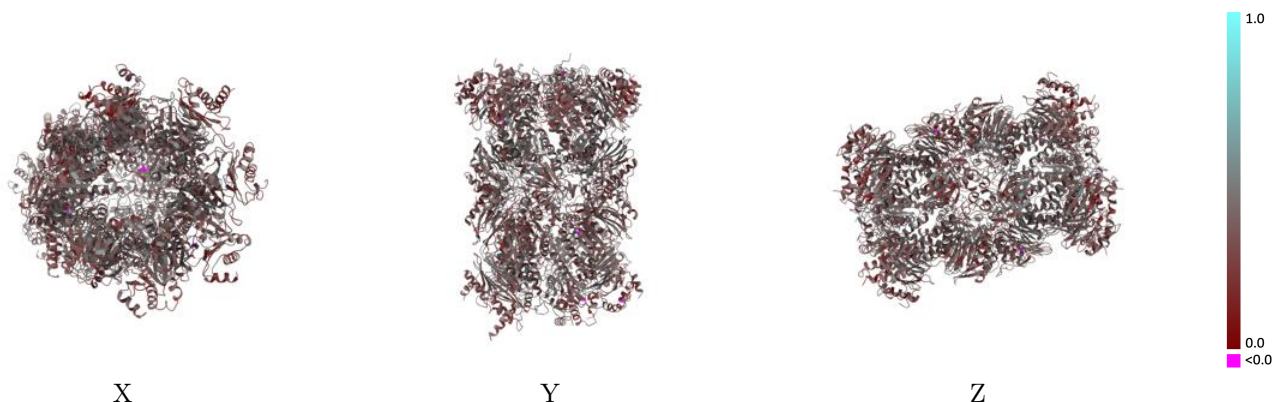

The images above show the model with each residue coloured according to its Q-score. This shows their resolvability in the map with higher Q-score values reflecting better resolvability. Please note: Q-score is calculating the resolvability of atoms, and thus high values are only expected at resolutions at which atoms can be resolved. Low Q-score values may therefore be expected for many entries.

## 9.3 Atom inclusion mapped to coordinate model [i](#)

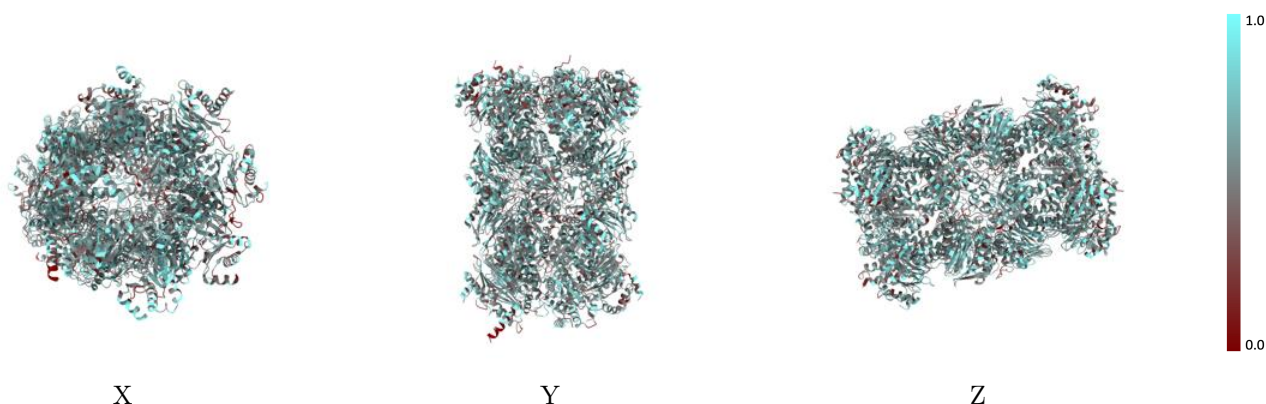

The images above show the model with each residue coloured according to its atom inclusion. This shows to what extent they are inside the map at the recommended contour level (0.0135).



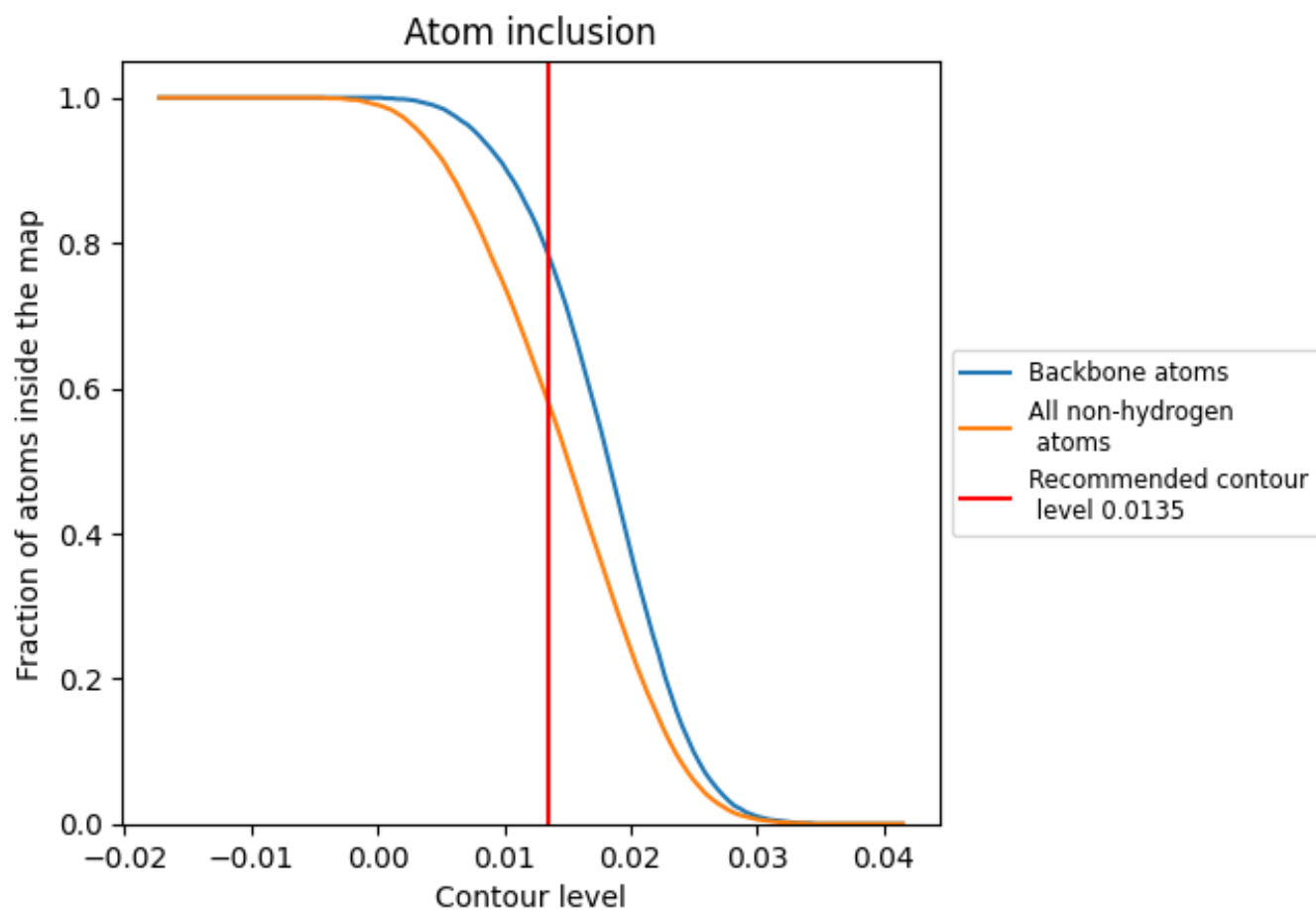























































## 9.4 Atom inclusion [i](#)



At the recommended contour level, 78% of all backbone atoms, 58% of all non-hydrogen atoms, are inside the map.

## 9.5 Map-model fit summary

The table lists the average atom inclusion at the recommended contour level (0.0135) and Q-score for the entire model and for each chain.

Chain	Atom inclusion	Q-score
All	 0.5810	 0.3640
A	 0.5650	 0.3540
B	 0.5970	 0.3760
C	 0.5570	 0.3680
D	 0.5840	 0.3620
E	 0.5390	 0.3460
F	 0.5710	 0.3490
G	 0.5770	 0.3630
H	 0.6040	 0.3800
I	 0.5830	 0.3730
J	 0.5790	 0.3790
K	 0.6150	 0.3920
L	 0.6340	 0.3860
M	 0.5580	 0.3800
N	 0.6230	 0.3910
O	 0.5680	 0.3480
P	 0.5970	 0.3690
Q	 0.5730	 0.3680
R	 0.5900	 0.3780
S	 0.5500	 0.3610
T	 0.5870	 0.3580
U	 0.6040	 0.3630
V	 0.5810	 0.3430
W	 0.5520	 0.3370
X	 0.5470	 0.3280
Y	 0.5900	 0.3560
Z	 0.6100	 0.3740
a	 0.5400	 0.3600
b	 0.6050	 0.3600

