



Full wwPDB EM Validation Report ⓘ

May 15, 2024 – 03:03 PM JST

PDB ID : 8HKV
EMDB ID : EMD-34861
Title : Cryo-EM Structures and Translocation Mechanism of Crenarchaeota Ribosome
Authors : Wang, Y.H.; Zhou, J.
Deposited on : 2022-11-28
Resolution : 4.94 Å(reported)

This is a Full wwPDB EM Validation Report for a publicly released PDB entry.

We welcome your comments at validation@mail.wwpdb.org

A user guide is available at

<https://www.wwpdb.org/validation/2017/EMValidationReportHelp>

with specific help available everywhere you see the ⓘ symbol.

The types of validation reports are described at

<http://www.wwpdb.org/validation/2017/FAQs#types>.

The following versions of software and data (see [references ⓘ](#)) were used in the production of this report:

EMDB validation analysis : 0.0.1.dev92
MolProbity : 4.02b-467
Percentile statistics : 20191225.v01 (using entries in the PDB archive December 25th 2019)
MapQ : 1.9.13
Ideal geometry (proteins) : Engh & Huber (2001)
Ideal geometry (DNA, RNA) : Parkinson et al. (1996)
Validation Pipeline (wwPDB-VP) : 2.36.2

1 Overall quality at a glance

The following experimental techniques were used to determine the structure:
ELECTRON MICROSCOPY

The reported resolution of this entry is 4.94 Å.

Percentile scores (ranging between 0-100) for global validation metrics of the entry are shown in the following graphic. The table shows the number of entries on which the scores are based.

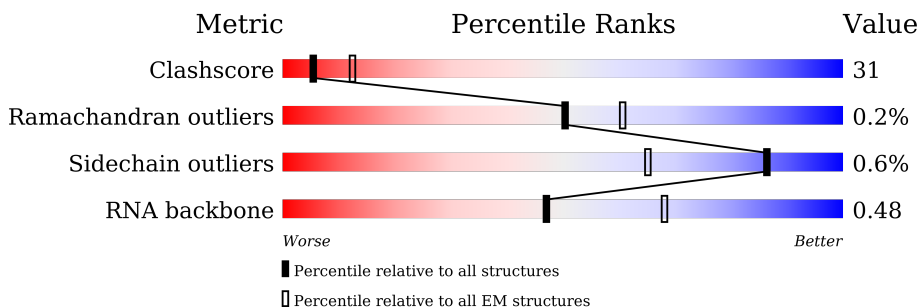

Metric	Whole archive (#Entries)	EM structures (#Entries)
Clashscore	158937	4297
Ramachandran outliers	154571	4023
Sidechain outliers	154315	3826
RNA backbone	4643	859

The table below summarises the geometric issues observed across the polymeric chains and their fit to the map. The red, orange, yellow and green segments of the bar indicate the fraction of residues that contain outliers for ≥ 3 , 2, 1 and 0 types of geometric quality criteria respectively. A grey segment represents the fraction of residues that are not modelled. The numeric value for each fraction is indicated below the corresponding segment, with a dot representing fractions $\leq 5\%$. The upper red bar (where present) indicates the fraction of residues that have poor fit to the EM map (all-atom inclusion $< 40\%$). The numeric value is given above the bar.

Mol	Chain	Length	Quality of chain
1	A23S	3022	 9% 72% 25% ..
2	A5S	122	 31% 56% 13%
3	AL2P	234	 24% 100%
4	AL3P	339	 9% 99%
5	AL4P	251	 100%
6	AL5P	168	 37% 100%
7	AL6P	181	 10% 99%

Continued on next page...

Continued from previous page...

Mol	Chain	Length	Quality of chain
8	ALX0	76	14% 99%
9	L10E	164	15% 99%
10	L13P	140	10% 99%
11	L141	86	9% 100%
11	L142	86	14% 99%
12	L14P	134	6% 100%
13	L15E	169	12% 100%
14	L18E	112	• 99%
15	L18P	193	11% 99%
16	L19E	144	• 100%
17	L22P	150	• 97%
18	L23P	81	6% 98%
19	L24E	54	• 100%
20	L24P	122	6% 99%
21	L29P	63	13% 98%
22	L30E	94	6% 99%
23	L30P	155	14% 99%
24	L31E	75	7% 99%
25	L32E	123	13% 100%
26	L34E	77	18% 95%
27	L37A	65	5% 100%
28	L37E	54	• 100%
29	L39E	49	14% 98%
30	L40E	55	36% 100%
31	L44E	92	15% 100%

Continued on next page...

Continued from previous page...

Mol	Chain	Length	Quality of chain
32	L7A1	123	<p>7% 100%</p>
32	L7A2	123	<p>25% 98%</p>
33	L15P	144	<p>8% 65% 35%</p>
34	L21E	97	<p>6% 100%</p>
35	L45A	101	<p>5% 95% 5%</p>
36	L46A	70	<p>6% 97%</p>
37	L47A	80	<p>26% 100%</p>

2 Entry composition [i](#)

There are 37 unique types of molecules in this entry. The entry contains 102540 atoms, of which 0 are hydrogens and 0 are deuteriums.

In the tables below, the AltConf column contains the number of residues with at least one atom in alternate conformation and the Trace column contains the number of residues modelled with at most 2 atoms.

- Molecule 1 is a RNA chain called 23s rRNA (2996-MER).

Mol	Chain	Residues	Atoms					AltConf	Trace
			Total	C	N	O	P		
1	A23S	2989	64210	28607	11884	20730	2989	0	0

- Molecule 2 is a RNA chain called 5s rRNA (122-MER).

Mol	Chain	Residues	Atoms					AltConf	Trace
			Total	C	N	O	P		
2	A5S	122	2609	1163	476	849	121	0	0

- Molecule 3 is a protein called 50S ribosomal protein L2.

Mol	Chain	Residues	Atoms					AltConf	Trace
			Total	C	N	O	S		
3	AL2P	234	1754	1101	344	307	2	0	0

- Molecule 4 is a protein called 50S ribosomal protein L3.

Mol	Chain	Residues	Atoms					AltConf	Trace
			Total	C	N	O	S		
4	AL3P	339	2695	1730	484	477	4	0	0

- Molecule 5 is a protein called 50S ribosomal protein L4.

Mol	Chain	Residues	Atoms					AltConf	Trace
			Total	C	N	O	S		
5	AL4P	251	1926	1223	356	345	2	0	0

- Molecule 6 is a protein called 50S ribosomal protein L5.

Mol	Chain	Residues	Atoms					AltConf	Trace
			Total	C	N	O	S		
6	AL5P	168	1343	854	253	232	4	0	0

- Molecule 7 is a protein called 50S ribosomal protein L6.

Mol	Chain	Residues	Atoms					AltConf	Trace
			Total	C	N	O	S		
7	AL6P	181	1431	920	246	264	1	0	0

- Molecule 8 is a protein called 50S ribosomal protein L18Ae.

Mol	Chain	Residues	Atoms					AltConf	Trace
			Total	C	N	O	S		
8	ALX0	76	629	403	110	115	1	0	0

- Molecule 9 is a protein called 50S ribosomal protein L10e.

Mol	Chain	Residues	Atoms					AltConf	Trace
			Total	C	N	O	S		
9	L10E	164	1310	837	239	227	7	0	0

- Molecule 10 is a protein called 50S ribosomal protein L13.

Mol	Chain	Residues	Atoms					AltConf	Trace
			Total	C	N	O	S		
10	L13P	140	1109	707	208	190	4	0	0

- Molecule 11 is a protein called 50S ribosomal protein L14e.

Mol	Chain	Residues	Atoms					AltConf	Trace
			Total	C	N	O	S		
11	L141	86	669	417	123	127	2	0	0
11	L142	86	669	417	123	127	2	0	0

- Molecule 12 is a protein called 50S ribosomal protein L14.

Mol	Chain	Residues	Atoms					AltConf	Trace
			Total	C	N	O	S		
12	L14P	134	1034	655	194	181	4	0	0

- Molecule 13 is a protein called 50S ribosomal protein L15e.

Mol	Chain	Residues	Atoms					AltConf	Trace
			Total	C	N	O	S		
13	L15E	169	1423	899	283	236	5	0	0

- Molecule 14 is a protein called 50S ribosomal protein L18e.

Mol	Chain	Residues	Atoms					AltConf	Trace
			Total	C	N	O	S		
14	L18E	112	895	576	163	153	3	0	0

- Molecule 15 is a protein called 50S ribosomal protein L18.

Mol	Chain	Residues	Atoms					AltConf	Trace
			Total	C	N	O	S		
15	L18P	193	1539	990	274	274	1	0	0

- Molecule 16 is a protein called 50S ribosomal protein L19e.

Mol	Chain	Residues	Atoms				AltConf	Trace
			Total	C	N	O		
16	L19E	144	1206	753	247	206	0	0

- Molecule 17 is a protein called 50S ribosomal protein L22.

Mol	Chain	Residues	Atoms					AltConf	Trace
			Total	C	N	O	S		
17	L22P	150	1223	782	225	213	3	0	0

- Molecule 18 is a protein called 50S ribosomal protein L23.

Mol	Chain	Residues	Atoms					AltConf	Trace
			Total	C	N	O	S		
18	L23P	81	650	419	109	121	1	0	0

- Molecule 19 is a protein called 50S ribosomal protein L24e.

Mol	Chain	Residues	Atoms					AltConf	Trace
			Total	C	N	O	S		
19	L24E	54	441	282	80	73	6	0	0

- Molecule 20 is a protein called 50S ribosomal protein L24.

Mol	Chain	Residues	Atoms					AltConf	Trace
			Total	C	N	O	S		
20	L24P	122	989	620	189	176	4	0	0

- Molecule 21 is a protein called 50S ribosomal protein L29.

Mol	Chain	Residues	Atoms					AltConf	Trace
21	L29P	63	Total	C	N	O	S	0	0
			513	319	95	96	3		

- Molecule 22 is a protein called 50S ribosomal protein L30e.

Mol	Chain	Residues	Atoms					AltConf	Trace
22	L30E	94	Total	C	N	O	S	0	0
			729	474	116	136	3		

- Molecule 23 is a protein called 50S ribosomal protein L30.

Mol	Chain	Residues	Atoms					AltConf	Trace
23	L30P	155	Total	C	N	O	S	0	0
			1254	804	222	223	5		

- Molecule 24 is a protein called 50S ribosomal protein L31e.

Mol	Chain	Residues	Atoms					AltConf	Trace
24	L31E	75	Total	C	N	O	S	0	0
			625	398	126	97	4		

- Molecule 25 is a protein called 50S ribosomal protein L32e.

Mol	Chain	Residues	Atoms					AltConf	Trace
25	L32E	123	Total	C	N	O	S	0	0
			1010	650	193	166	1		

- Molecule 26 is a protein called 50S ribosomal protein L34e.

Mol	Chain	Residues	Atoms					AltConf	Trace
26	L34E	77	Total	C	N	O	S	0	0
			629	395	119	110	5		

- Molecule 27 is a protein called 50S ribosomal protein L37Ae.

Mol	Chain	Residues	Atoms					AltConf	Trace
27	L37A	65	Total	C	N	O	S	0	0
			527	335	99	87	6		

- Molecule 28 is a protein called 50S ribosomal protein L37e.

Mol	Chain	Residues	Atoms					AltConf	Trace
			Total	C	N	O	S		
28	L37E	54	436	267	94	69	6	0	0

- Molecule 29 is a protein called 50S ribosomal protein L39e.

Mol	Chain	Residues	Atoms					AltConf	Trace
			Total	C	N	O	S		
29	L39E	49	414	265	88	61		0	0

- Molecule 30 is a protein called 50S ribosomal protein L40E.

Mol	Chain	Residues	Atoms					AltConf	Trace
			Total	C	N	O	S		
30	L40E	55	439	273	89	72	5	0	0

- Molecule 31 is a protein called 50S ribosomal protein L44e.

Mol	Chain	Residues	Atoms					AltConf	Trace
			Total	C	N	O	S		
31	L44E	92	753	474	144	129	6	0	0

- Molecule 32 is a protein called 50S ribosomal protein L7Ae.

Mol	Chain	Residues	Atoms					AltConf	Trace
			Total	C	N	O	S		
32	L7A1	123	935	593	155	184	3	0	0
32	L7A2	123	935	593	155	184	3	0	0

- Molecule 33 is a protein called 50S ribosomal protein L15.

Mol	Chain	Residues	Atoms					AltConf	Trace
			Total	C	N	O	S		
33	L15P	94	752	487	131	133	1	0	0

- Molecule 34 is a protein called 50S ribosomal protein L21e.

Mol	Chain	Residues	Atoms					AltConf	Trace
			Total	C	N	O	S		
34	L21E	97	785	502	152	129	2	0	0

- Molecule 35 is a protein called DUF2280 domain-containing protein.

Mol	Chain	Residues	Atoms					AltConf	Trace
			Total	C	N	O	S		
35	L45A	101	816	515	141	156	4	0	0

- Molecule 36 is a protein called Conserved protein.

Mol	Chain	Residues	Atoms					AltConf	Trace
			Total	C	N	O	S		
36	L46A	70	586	382	101	102	1	0	0

- Molecule 37 is a protein called 50S ribosomal protein L47A.

Mol	Chain	Residues	Atoms					AltConf	Trace
			Total	C	N	O	S		
37	L47A	80	648	405	113	128	2	0	0

3 Residue-property plots i

These plots are drawn for all protein, RNA, DNA and oligosaccharide chains in the entry. The first graphic for a chain summarises the proportions of the various outlier classes displayed in the second graphic. The second graphic shows the sequence view annotated by issues in geometry and atom inclusion in map density. Residues are color-coded according to the number of geometric quality criteria for which they contain at least one outlier: green = 0, yellow = 1, orange = 2 and red = 3 or more. A red diamond above a residue indicates a poor fit to the EM map for this residue (all-atom inclusion < 40%). Stretches of 2 or more consecutive residues without any outlier are shown as a green connector. Residues present in the sample, but not in the model, are shown in grey.

• Molecule 1: 23s rRNA (2996-MER)

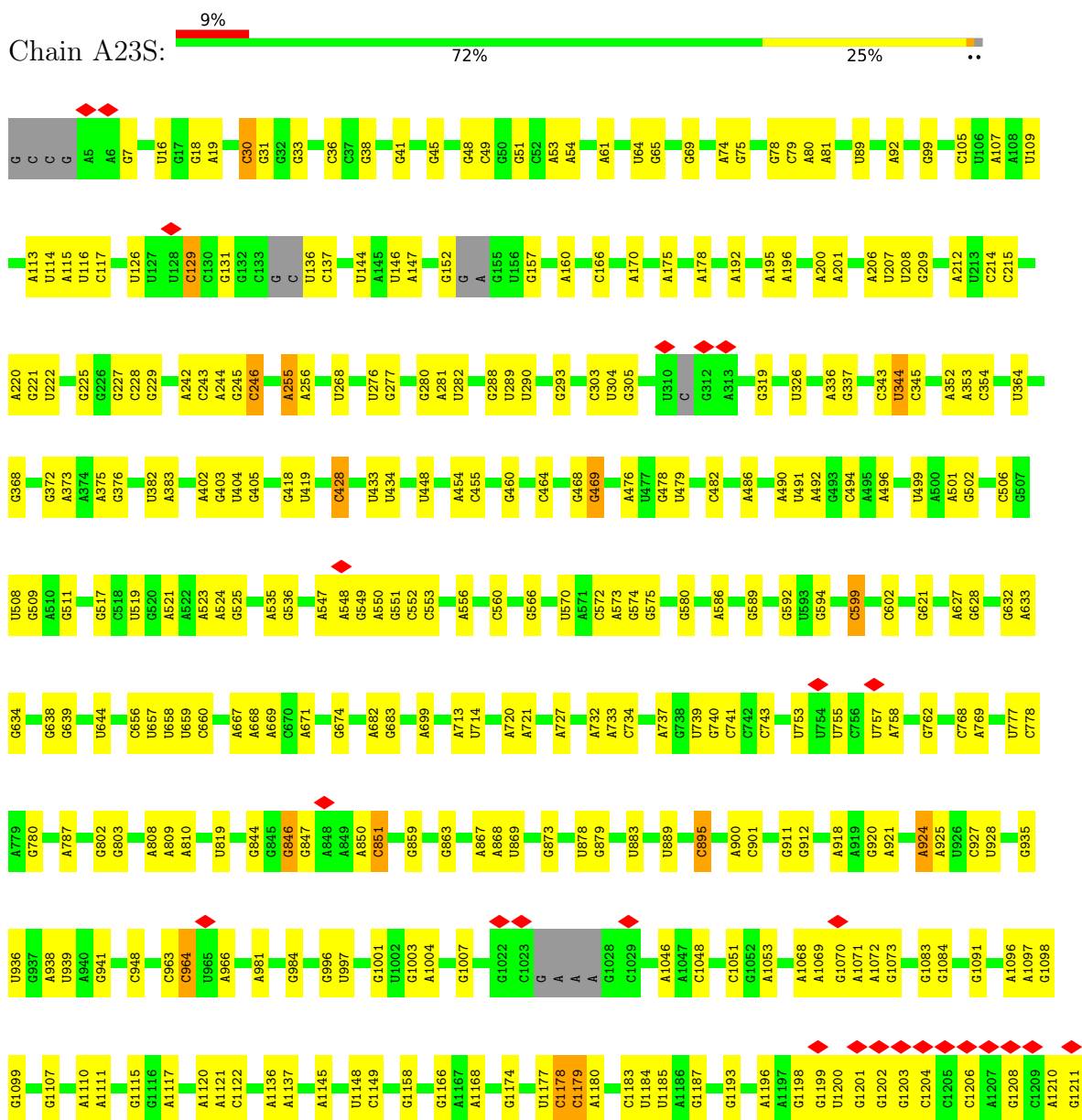

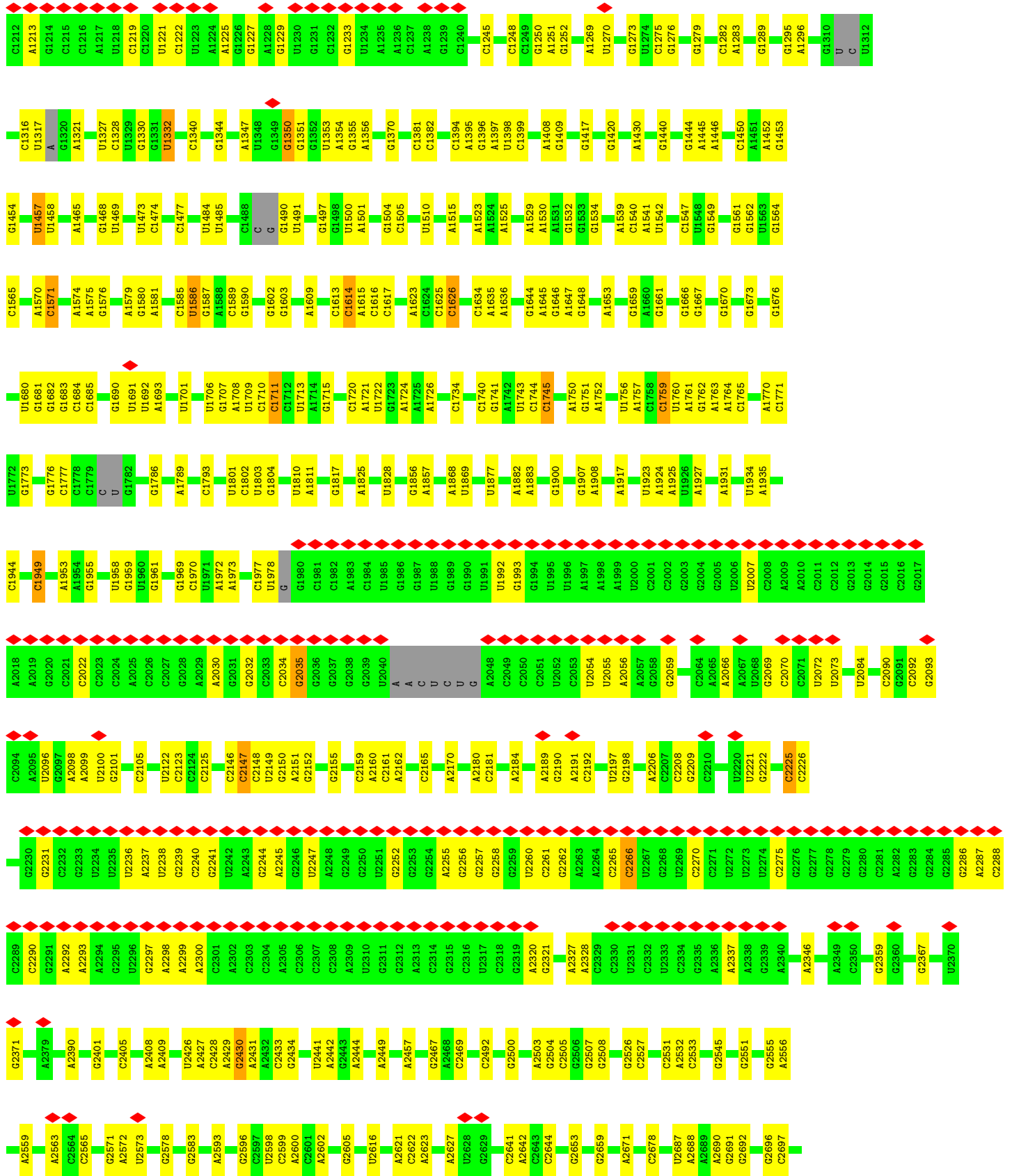

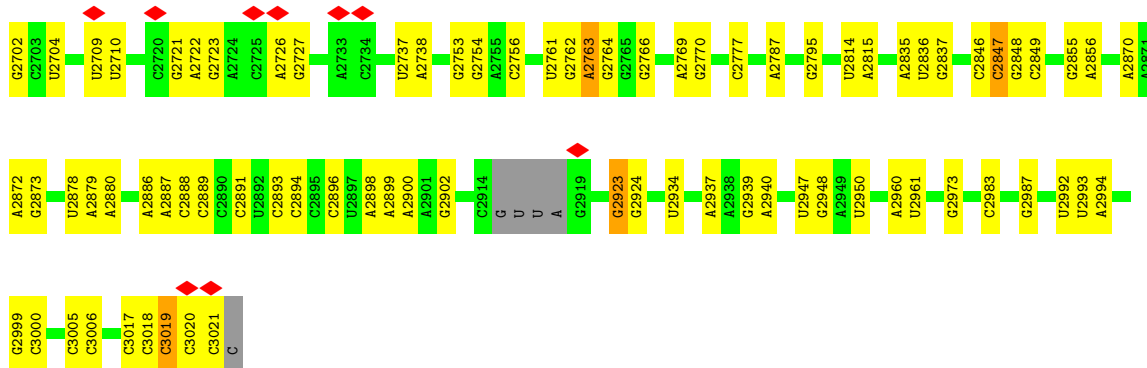

• Molecule 2: 5s rRNA (122-MER)

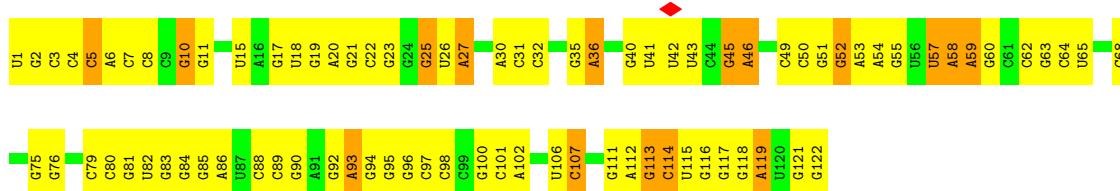

• Molecule 3: 50S ribosomal protein L2

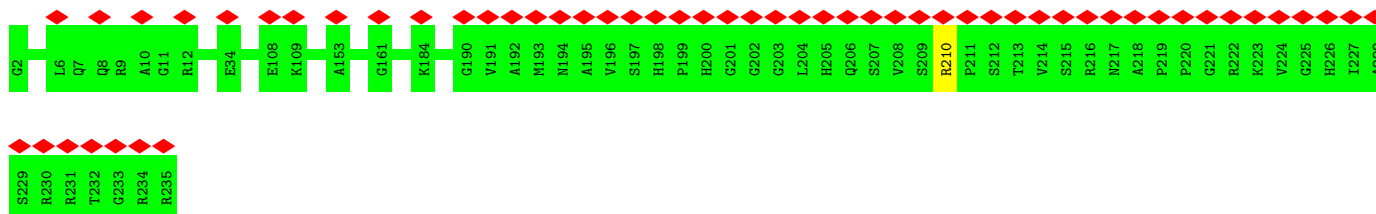

• Molecule 4: 50S ribosomal protein L3



• Molecule 5: 50S ribosomal protein L4



• Molecule 6: 50S ribosomal protein L5

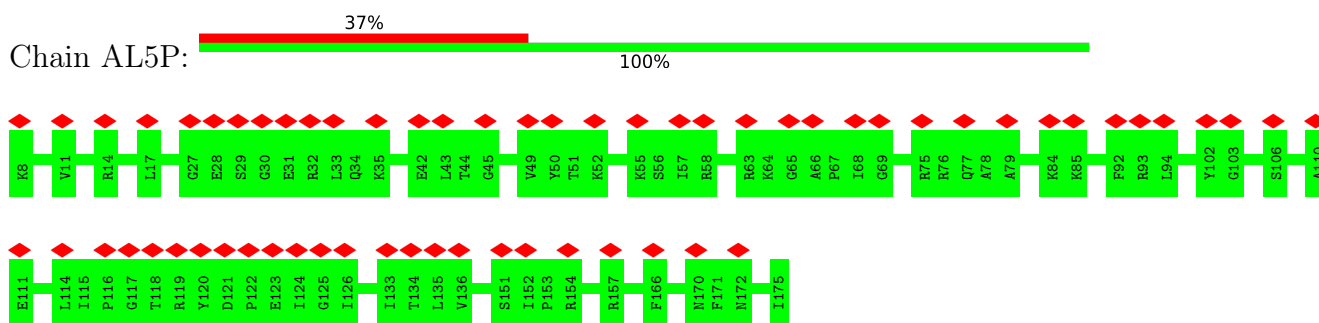

- Molecule 7: 50S ribosomal protein L6

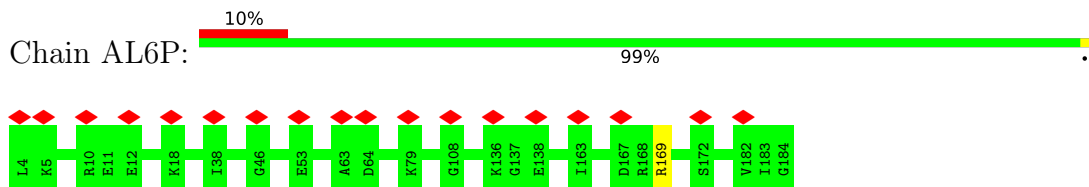

- Molecule 8: 50S ribosomal protein L18Ae

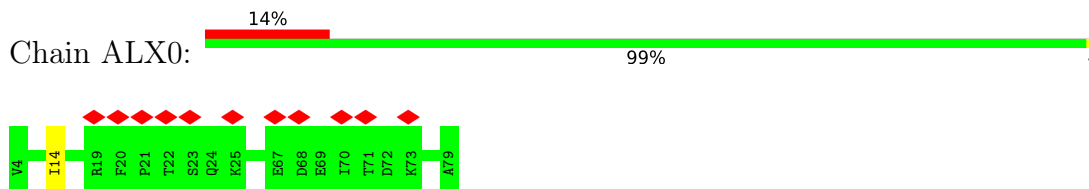

- Molecule 9: 50S ribosomal protein L10e

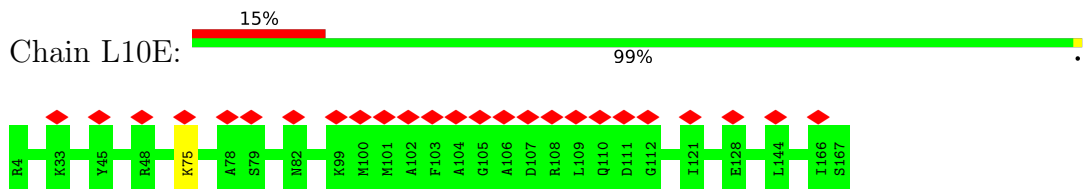

- Molecule 10: 50S ribosomal protein L13

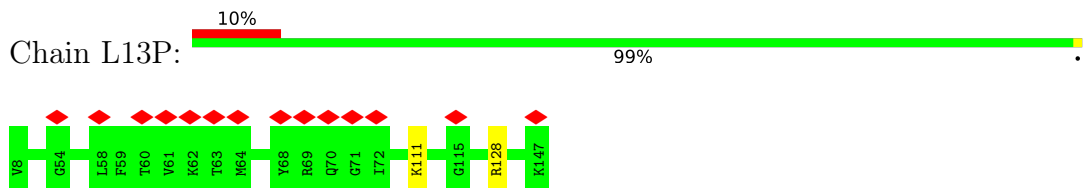

- Molecule 11: 50S ribosomal protein L14e

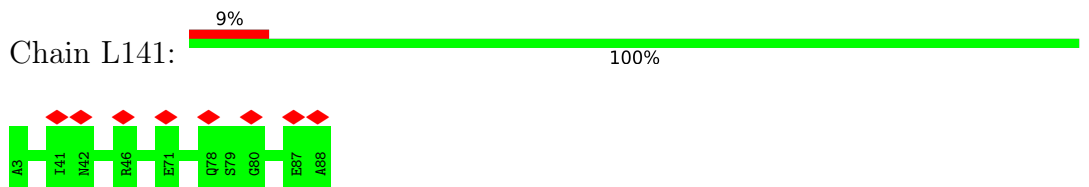

- Molecule 11: 50S ribosomal protein L14e



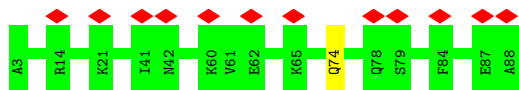

- Molecule 12: 50S ribosomal protein L14

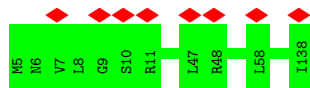

- Molecule 13: 50S ribosomal protein L15e

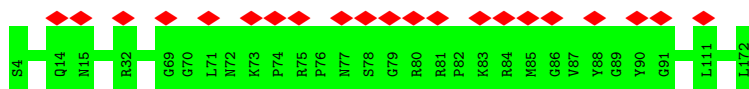

- Molecule 14: 50S ribosomal protein L18e

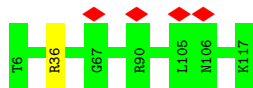

- Molecule 15: 50S ribosomal protein L18

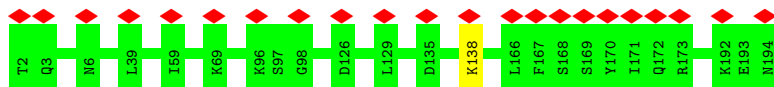

- Molecule 16: 50S ribosomal protein L19e

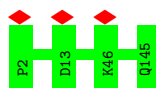

- Molecule 17: 50S ribosomal protein L22

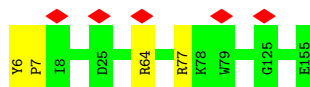

- Molecule 18: 50S ribosomal protein L23

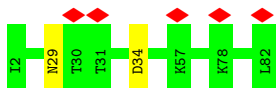

- Molecule 19: 50S ribosomal protein L24e



There are no outlier residues recorded for this chain.

- Molecule 20: 50S ribosomal protein L24

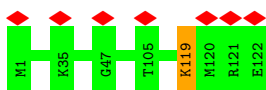

- Molecule 21: 50S ribosomal protein L29

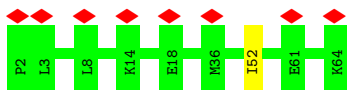

- Molecule 22: 50S ribosomal protein L30e

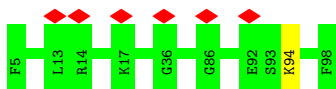

- Molecule 23: 50S ribosomal protein L30

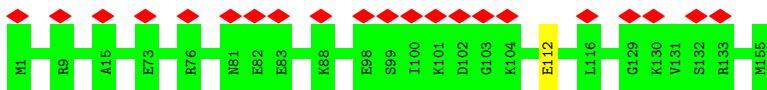

- Molecule 24: 50S ribosomal protein L31e

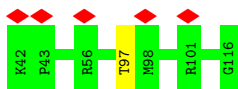

- Molecule 25: 50S ribosomal protein L32e



- Molecule 26: 50S ribosomal protein L34e



- Molecule 27: 50S ribosomal protein L37Ae

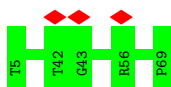

- Molecule 28: 50S ribosomal protein L37e



- Molecule 29: 50S ribosomal protein L39e

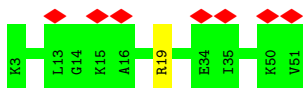

- Molecule 30: 50S ribosomal protein L40E

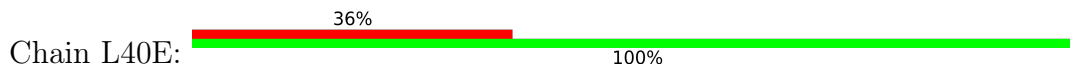

- Molecule 31: 50S ribosomal protein L44e

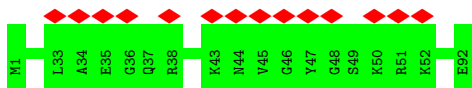

- Molecule 32: 50S ribosomal protein L7Ae

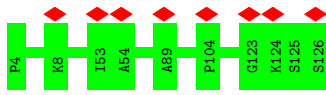

- Molecule 32: 50S ribosomal protein L7Ae

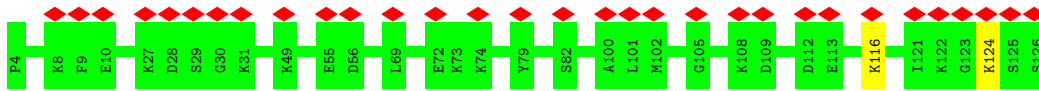

- Molecule 33: 50S ribosomal protein L15

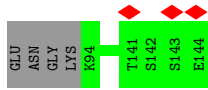
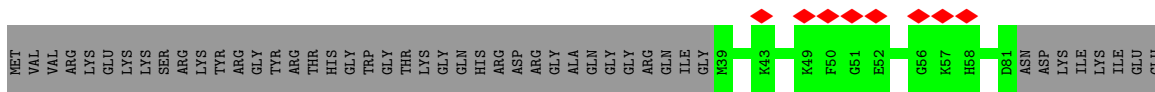

- Molecule 34: 50S ribosomal protein L21e

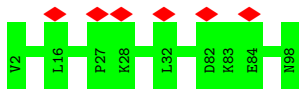

- Molecule 35: DUF2280 domain-containing protein

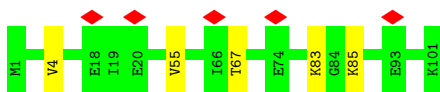

- Molecule 36: Conserved protein

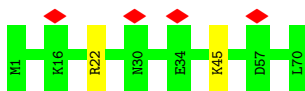

- Molecule 37: 50S ribosomal protein L47A

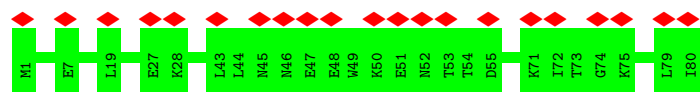

4 Experimental information

Property	Value	Source
EM reconstruction method	SINGLE PARTICLE	Depositor
Imposed symmetry	POINT, Not provided	
Number of particles used	617754	Depositor
Resolution determination method	FSC 0.143 CUT-OFF	Depositor
CTF correction method	PHASE FLIPPING AND AMPLITUDE CORRECTION	Depositor
Microscope	FEI TITAN KRIOS	Depositor
Voltage (kV)	300	Depositor
Electron dose ($e^-/\text{\AA}^2$)	26.7	Depositor
Minimum defocus (nm)	1000	Depositor
Maximum defocus (nm)	3000	Depositor
Magnification	Not provided	
Image detector	GATAN K2 SUMMIT (4k x 4k)	Depositor
Maximum map value	4.481	Depositor
Minimum map value	-2.589	Depositor
Average map value	-0.006	Depositor
Map value standard deviation	0.178	Depositor
Recommended contour level	0.69	Depositor
Map size (\AA)	432.00003, 432.00003, 432.00003	wwPDB
Map dimensions	180, 180, 180	wwPDB
Map angles ($^\circ$)	90.0, 90.0, 90.0	wwPDB
Pixel spacing (\AA)	2.4, 2.4, 2.4	Depositor

5 Model quality i

5.1 Standard geometry i

The Z score for a bond length (or angle) is the number of standard deviations the observed value is removed from the expected value. A bond length (or angle) with $|Z| > 5$ is considered an outlier worth inspection. RMSZ is the root-mean-square of all Z scores of the bond lengths (or angles).

Mol	Chain	Bond lengths		Bond angles	
		RMSZ	# Z >5	RMSZ	# Z >5
1	A23S	0.63	3/71882 (0.0%)	0.99	152/112144 (0.1%)
2	A5S	0.39	0/2917	0.73	0/4549
3	AL2P	0.35	0/1787	0.57	0/2409
4	AL3P	0.38	0/2758	0.59	0/3727
5	AL4P	0.38	0/1956	0.59	0/2635
6	AL5P	0.27	0/1364	0.55	0/1827
7	AL6P	0.31	0/1450	0.52	0/1949
8	ALX0	0.34	0/638	0.64	0/851
9	L10E	0.30	0/1334	0.56	0/1787
10	L13P	0.34	0/1123	0.60	0/1502
11	L141	0.35	0/673	0.58	0/900
11	L142	0.30	0/673	0.55	0/900
12	L14P	0.34	0/1054	0.59	0/1425
13	L15E	0.37	0/1458	0.63	0/1956
14	L18E	0.35	0/907	0.56	0/1214
15	L18P	0.30	0/1570	0.49	0/2115
16	L19E	0.35	0/1223	0.60	0/1622
17	L22P	0.39	0/1246	0.60	0/1671
18	L23P	0.35	0/655	0.55	0/874
19	L24E	0.36	0/451	0.55	0/599
20	L24P	0.34	0/1000	0.61	0/1329
21	L29P	0.30	0/513	0.60	0/678
22	L30E	0.33	0/738	0.51	0/985
23	L30P	0.38	0/1278	0.60	0/1713
24	L31E	0.39	0/632	0.65	0/837
25	L32E	0.39	0/1027	0.59	0/1366
26	L34E	0.42	0/642	0.78	1/854 (0.1%)
27	L37A	0.36	0/542	0.59	0/726
28	L37E	0.42	0/445	0.69	0/585
29	L39E	0.38	0/422	0.71	0/562
30	L40E	0.30	0/443	0.58	0/587
31	L44E	0.29	0/763	0.52	0/1008
32	L7A1	0.29	0/946	0.43	0/1272
32	L7A2	0.29	0/946	0.47	0/1272

Mol	Chain	Bond lengths		Bond angles	
		RMSZ	# Z >5	RMSZ	# Z >5
33	L15P	0.32	0/766	0.55	0/1023
34	L21E	0.31	0/800	0.53	0/1067
35	L45A	0.34	0/824	0.56	0/1094
36	L46A	0.35	0/595	0.53	0/793
37	L47A	0.31	0/652	0.56	0/870
All	All	0.55	3/111093 (0.0%)	0.88	153/165277 (0.1%)

Chiral center outliers are detected by calculating the chiral volume of a chiral center and verifying if the center is modelled as a planar moiety or with the opposite hand. A planarity outlier is detected by checking planarity of atoms in a peptide group, atoms in a mainchain group or atoms of a sidechain that are expected to be planar.

Mol	Chain	#Chirality outliers	#Planarity outliers
4	AL3P	0	1
8	ALX0	0	1
17	L22P	0	1
18	L23P	0	1
20	L24P	0	1
23	L30P	0	1
24	L31E	0	1
26	L34E	0	1
29	L39E	0	1
All	All	0	9

All (3) bond length outliers are listed below:

Mol	Chain	Res	Type	Atoms	Z	Observed(Å)	Ideal(Å)
1	A23S	1179	C	N1-C6	-6.93	1.32	1.37
1	A23S	1179	C	C4-C5	-5.82	1.38	1.43
1	A23S	924	A	N9-C4	-5.05	1.34	1.37

All (153) bond angle outliers are listed below:

Mol	Chain	Res	Type	Atoms	Z	Observed(°)	Ideal(°)
1	A23S	2433	C	N3-C4-N4	-21.43	103.00	118.00
1	A23S	2430	G	N1-C6-O6	-16.75	109.85	119.90
1	A23S	2433	C	C5-C4-N4	15.94	131.36	120.20
1	A23S	2430	G	C5-C6-O6	13.65	136.79	128.60
1	A23S	469	G	N3-C4-N9	12.72	133.63	126.00
1	A23S	1179	C	C6-N1-C2	-12.14	115.44	120.30
1	A23S	2034	C	OP2-P-O3'	-11.01	80.98	105.20
1	A23S	255	A	OP2-P-O3'	-10.96	81.08	105.20

Continued on next page...

Continued from previous page...

Mol	Chain	Res	Type	Atoms	Z	Observed(°)	Ideal(°)
1	A23S	469	G	C8-N9-C1'	-10.96	112.76	127.00
1	A23S	469	G	C6-C5-N7	-10.92	123.85	130.40
1	A23S	246	C	C6-N1-C1'	-10.79	107.86	120.80
1	A23S	469	G	C4-N9-C1'	10.61	140.29	126.50
1	A23S	255	A	OP1-P-O3'	-10.44	82.23	105.20
1	A23S	469	G	N9-C4-C5	-10.00	101.40	105.40
1	A23S	1179	C	C5-C6-N1	9.86	125.93	121.00
1	A23S	469	G	C4-C5-N7	9.75	114.70	110.80
1	A23S	246	C	C2-N1-C1'	9.39	129.13	118.80
1	A23S	2034	C	OP1-P-O3'	-9.16	85.06	105.20
1	A23S	846	G	N1-C6-O6	-9.05	114.47	119.90
1	A23S	1179	C	N1-C2-O2	8.89	124.23	118.90
1	A23S	1626	C	C6-N1-C2	-8.88	116.75	120.30
1	A23S	3018	C	N3-C2-O2	-8.86	115.70	121.90
1	A23S	1759	C	N3-C2-O2	-8.81	115.73	121.90
1	A23S	656	C	N3-C2-O2	-8.80	115.74	121.90
1	A23S	1626	C	N3-C2-O2	-8.70	115.81	121.90
1	A23S	2641	C	N3-C2-O2	-8.64	115.85	121.90
1	A23S	428	C	N3-C2-O2	-8.46	115.97	121.90
1	A23S	2894	C	N3-C2-O2	-8.32	116.08	121.90
1	A23S	2433	C	C4-C5-C6	-8.26	113.27	117.40
1	A23S	2433	C	N3-C4-C5	8.20	125.18	121.90
1	A23S	964	C	N1-C2-O2	8.08	123.75	118.90
1	A23S	469	G	C5-C6-O6	-8.00	123.80	128.60
1	A23S	246	C	N3-C4-C5	7.94	125.08	121.90
1	A23S	256	A	OP1-P-OP2	7.80	131.30	119.60
1	A23S	964	C	C2-N1-C1'	7.72	127.30	118.80
1	A23S	846	G	C5-C6-O6	7.72	133.23	128.60
1	A23S	1949	C	N3-C2-O2	-7.61	116.57	121.90
1	A23S	2035	G	OP1-P-OP2	7.55	130.92	119.60
1	A23S	873	G	N3-C4-N9	-7.46	121.52	126.00
1	A23S	1457	U	N3-C2-O2	-7.46	116.97	122.20
1	A23S	2847	C	N1-C2-O2	-7.34	114.50	118.90
1	A23S	469	G	N3-C4-C5	-7.33	124.93	128.60
1	A23S	1457	U	C2-N1-C1'	7.32	126.49	117.70
1	A23S	3019	C	N1-C2-O2	7.32	123.29	118.90
1	A23S	1179	C	N3-C4-N4	7.26	123.08	118.00
1	A23S	1745	C	N3-C2-O2	-7.22	116.84	121.90
1	A23S	1759	C	N1-C2-N3	7.17	124.22	119.20
1	A23S	1178	C	C2-N1-C1'	7.15	126.66	118.80
1	A23S	1454	G	C6-N1-C2	-7.10	120.84	125.10
1	A23S	1179	C	C2-N1-C1'	7.05	126.56	118.80

Continued on next page...

Continued from previous page...

Mol	Chain	Res	Type	Atoms	Z	Observed(°)	Ideal(°)
1	A23S	1547	C	N3-C2-O2	-7.03	116.98	121.90
1	A23S	1793	C	C6-N1-C2	-7.02	117.49	120.30
1	A23S	1793	C	N3-C2-O2	-7.00	117.00	121.90
1	A23S	1626	C	N1-C2-O2	6.98	123.09	118.90
1	A23S	2763	A	N1-C2-N3	6.95	132.77	129.30
1	A23S	1626	C	C5-C6-N1	6.92	124.46	121.00
1	A23S	1179	C	N3-C2-O2	-6.84	117.11	121.90
1	A23S	482	C	N1-C2-O2	6.82	122.99	118.90
1	A23S	895	C	N3-C2-O2	-6.74	117.18	121.90
1	A23S	560	C	C6-N1-C2	-6.65	117.64	120.30
1	A23S	1626	C	C2-N1-C1'	6.57	126.03	118.80
1	A23S	2846	C	N3-C2-O2	-6.56	117.31	121.90
1	A23S	2433	C	N1-C2-O2	6.51	122.81	118.90
1	A23S	1759	C	C2-N3-C4	-6.50	116.65	119.90
1	A23S	1178	C	C6-N1-C2	-6.50	117.70	120.30
1	A23S	2763	A	C2-N3-C4	-6.47	107.36	110.60
1	A23S	656	C	N1-C2-O2	6.46	122.77	118.90
1	A23S	1711	C	C2-N1-C1'	6.34	125.77	118.80
1	A23S	599	C	C2-N1-C1'	6.31	125.74	118.80
1	A23S	215	C	C6-N1-C2	-6.30	117.78	120.30
1	A23S	1454	G	N1-C2-N3	6.29	127.67	123.90
1	A23S	214	C	N1-C2-O2	6.26	122.66	118.90
1	A23S	496	A	O4'-C1'-N9	6.21	113.17	108.20
1	A23S	428	C	C6-N1-C2	-6.21	117.82	120.30
1	A23S	964	C	N3-C2-O2	-6.15	117.59	121.90
1	A23S	873	G	N3-C4-C5	5.99	131.60	128.60
1	A23S	3019	C	N3-C2-O2	-5.99	117.71	121.90
1	A23S	215	C	N3-C2-O2	-5.96	117.73	121.90
1	A23S	2266	C	N3-C2-O2	-5.95	117.74	121.90
1	A23S	1332	U	N3-C2-O2	-5.88	118.08	122.20
1	A23S	1745	C	C6-N1-C2	-5.87	117.95	120.30
1	A23S	1571	C	N3-C2-O2	-5.86	117.80	121.90
1	A23S	129	C	N3-C2-O2	-5.86	117.80	121.90
1	A23S	851	C	N3-C2-O2	-5.86	117.80	121.90
1	A23S	1179	C	C5'-C4'-O4'	5.84	116.11	109.10
1	A23S	2766	G	N1-C6-O6	-5.76	116.44	119.90
1	A23S	1457	U	N1-C2-O2	5.75	126.82	122.80
1	A23S	2070	C	N1-C2-O2	5.73	122.34	118.90
1	A23S	1626	C	O5'-P-OP2	5.72	117.56	110.70
1	A23S	2894	C	C6-N1-C2	-5.72	118.01	120.30
1	A23S	1626	C	O4'-C1'-N1	5.71	112.77	108.20
1	A23S	2265	C	N1-C2-O2	5.71	122.32	118.90

Continued on next page...

Continued from previous page...

Mol	Chain	Res	Type	Atoms	Z	Observed(°)	Ideal(°)
1	A23S	895	C	N1-C2-N3	5.69	123.19	119.20
1	A23S	79	C	N3-C2-O2	-5.69	117.92	121.90
1	A23S	246	C	C6-N1-C2	5.69	122.58	120.30
1	A23S	873	G	C5-C6-O6	5.67	132.00	128.60
1	A23S	964	C	C6-N1-C1'	-5.66	114.00	120.80
1	A23S	508	U	N1-C2-N3	-5.65	111.51	114.90
1	A23S	602	C	C2-N1-C1'	5.64	125.00	118.80
1	A23S	482	C	N3-C2-O2	-5.62	117.96	121.90
1	A23S	3018	C	C6-N1-C2	-5.62	118.05	120.30
1	A23S	2777	C	N3-C2-O2	-5.61	117.97	121.90
1	A23S	895	C	C5-C4-N4	5.60	124.12	120.20
1	A23S	873	G	C2-N3-C4	-5.58	109.11	111.90
1	A23S	1179	C	N3-C4-C5	-5.57	119.67	121.90
1	A23S	1248	C	N3-C2-O2	-5.54	118.02	121.90
1	A23S	2090	C	N1-C2-O2	5.53	122.22	118.90
1	A23S	344	U	C5-C6-N1	-5.53	119.94	122.70
1	A23S	1204	C	N1-C2-O2	5.51	122.21	118.90
1	A23S	560	C	N3-C2-O2	-5.50	118.05	121.90
1	A23S	246	C	C5-C4-N4	-5.49	116.35	120.20
1	A23S	2923	G	N1-C6-O6	-5.47	116.61	119.90
1	A23S	508	U	C2-N1-C1'	5.46	124.26	117.70
1	A23S	486	A	O4'-C1'-N9	5.44	112.55	108.20
1	A23S	1793	C	N1-C2-N3	5.42	123.00	119.20
1	A23S	599	C	C6-N1-C1'	-5.42	114.30	120.80
1	A23S	1179	C	O4'-C1'-N1	5.40	112.52	108.20
1	A23S	2147	C	C2-N1-C1'	5.40	124.74	118.80
1	A23S	30	C	C2-N1-C1'	5.39	124.73	118.80
1	A23S	2123	C	C2-N1-C1'	5.37	124.70	118.80
1	A23S	214	C	N3-C2-O2	-5.36	118.15	121.90
1	A23S	1614	C	N1-C2-O2	5.35	122.11	118.90
1	A23S	984	G	N1-C6-O6	-5.31	116.71	119.90
1	A23S	2022	C	N3-C2-O2	-5.31	118.18	121.90
1	A23S	1586	U	C5-C6-N1	5.29	125.35	122.70
1	A23S	2469	C	C2-N1-C1'	-5.29	112.98	118.80
1	A23S	508	U	C6-N1-C1'	-5.29	113.80	121.20
1	A23S	1350	G	N9-C4-C5	-5.28	103.29	105.40
1	A23S	1248	C	N1-C2-O2	5.28	122.06	118.90
1	A23S	560	C	N1-C2-N3	5.26	122.88	119.20
1	A23S	2641	C	N1-C2-O2	5.23	122.04	118.90
1	A23S	2225	C	C2-N1-C1'	5.19	124.51	118.80
1	A23S	1450	C	N3-C4-C5	5.19	123.98	121.90
1	A23S	344	U	C2-N1-C1'	-5.19	111.48	117.70

Continued on next page...

Continued from previous page...

Mol	Chain	Res	Type	Atoms	Z	Observed(°)	Ideal(°)
1	A23S	214	C	C2-N1-C1'	5.17	124.49	118.80
1	A23S	1382	C	C6-N1-C2	5.15	122.36	120.30
1	A23S	2433	C	N1-C2-N3	-5.14	115.60	119.20
1	A23S	246	C	O4'-C1'-N1	5.13	112.31	108.20
1	A23S	1759	C	C6-N1-C2	-5.13	118.25	120.30
1	A23S	3019	C	C2-N1-C1'	5.13	124.44	118.80
26	L34E	19	PRO	N-CA-C	5.12	125.42	112.10
1	A23S	2430	G	C6-C5-N7	5.11	133.47	130.40
1	A23S	2923	G	C5-C6-O6	5.10	131.66	128.60
1	A23S	1685	C	N3-C2-O2	-5.09	118.33	121.90
1	A23S	3018	C	N1-C2-O2	5.08	121.95	118.90
1	A23S	1711	C	C6-N1-C1'	-5.05	114.74	120.80
1	A23S	2692	G	N1-C6-O6	-5.05	116.87	119.90
1	A23S	602	C	N3-C2-O2	-5.04	118.37	121.90
1	A23S	1803	U	O4'-C1'-N1	5.04	112.23	108.20
1	A23S	2598	U	N1-C2-O2	5.04	126.33	122.80
1	A23S	2123	C	N1-C2-O2	5.02	121.91	118.90
1	A23S	2893	C	N1-C2-O2	5.02	121.91	118.90
1	A23S	2070	C	N3-C2-O2	-5.02	118.39	121.90

There are no chirality outliers.

All (9) planarity outliers are listed below:

Mol	Chain	Res	Type	Group
4	AL3P	252	PRO	Peptide
8	ALX0	14	ILE	Peptide
17	L22P	6	TYR	Peptide
18	L23P	34	ASP	Peptide
20	L24P	119	LYS	Peptide
23	L30P	112	GLU	Peptide
24	L31E	97	THR	Peptide
26	L34E	36	ARG	Peptide
29	L39E	19	ARG	Peptide

5.2 Too-close contacts

In the following table, the Non-H and H(model) columns list the number of non-hydrogen atoms and hydrogen atoms in the chain respectively. The H(added) column lists the number of hydrogen atoms added and optimized by MolProbity. The Clashes column lists the number of clashes within the asymmetric unit, whereas Symm-Clashes lists symmetry-related clashes.

Mol	Chain	Non-H	H(model)	H(added)	Clashes	Symm-Clashes
1	A23S	64210	0	0	0	0
2	A5S	2609	0	1324	78	0
3	AL2P	1754	0	0	0	0
4	AL3P	2695	0	0	0	0
5	AL4P	1926	0	0	0	0
6	AL5P	1343	0	0	0	0
7	AL6P	1431	0	0	0	0
8	ALX0	629	0	0	0	0
9	L10E	1310	0	0	0	0
10	L13P	1109	0	0	0	0
11	L141	669	0	0	0	0
11	L142	669	0	0	0	0
12	L14P	1034	0	0	0	0
13	L15E	1423	0	0	0	0
14	L18E	895	0	0	0	0
15	L18P	1539	0	0	0	0
16	L19E	1206	0	0	0	0
17	L22P	1223	0	0	0	0
18	L23P	650	0	0	0	0
19	L24E	441	0	0	0	0
20	L24P	989	0	0	0	0
21	L29P	513	0	0	0	0
22	L30E	729	0	0	0	0
23	L30P	1254	0	0	0	0
24	L31E	625	0	0	0	0
25	L32E	1010	0	0	0	0
26	L34E	629	0	0	0	0
27	L37A	527	0	0	0	0
28	L37E	436	0	0	0	0
29	L39E	414	0	0	0	0
30	L40E	439	0	0	0	0
31	L44E	753	0	0	0	0
32	L7A1	935	0	0	0	0
32	L7A2	935	0	0	0	0
33	L15P	752	0	0	0	0
34	L21E	785	0	0	0	0
35	L45A	816	0	0	0	0
36	L46A	586	0	0	0	0
37	L47A	648	0	0	0	0
All	All	102540	0	1324	78	0

The all-atom clashscore is defined as the number of clashes found per 1000 atoms (including hydrogen atoms). The all-atom clashscore for this structure is 31.

All (78) close contacts within the same asymmetric unit are listed below, sorted by their clash magnitude.

Atom-1	Atom-2	Interatomic distance (Å)	Clash overlap (Å)
2:A5S:8:C:H42	2:A5S:117:G:H1	1.30	0.77
2:A5S:95:G:H2'	2:A5S:96:G:H8	1.51	0.75
2:A5S:41:U:O2'	2:A5S:46:A:N6	2.25	0.69
2:A5S:95:G:H2'	2:A5S:96:G:C8	2.28	0.68
2:A5S:5:C:H2'	2:A5S:6:A:C8	2.32	0.65
2:A5S:6:A:H61	2:A5S:119:A:H61	1.47	0.62
2:A5S:116:G:H2'	2:A5S:117:G:H8	1.66	0.60
2:A5S:32:C:H1'	2:A5S:54:A:H61	1.67	0.60
2:A5S:32:C:O2'	2:A5S:54:A:N1	2.30	0.59
2:A5S:22:C:H2'	2:A5S:23:G:H8	1.67	0.59
2:A5S:76:G:H1	2:A5S:106:U:H3	1.53	0.57
2:A5S:7:C:H2'	2:A5S:8:C:C6	2.40	0.56
2:A5S:51:G:C2	2:A5S:52:G:H1'	2.40	0.56
2:A5S:121:G:H2'	2:A5S:122:G:H8	1.71	0.55
2:A5S:8:C:N4	2:A5S:117:G:H1	2.03	0.55
2:A5S:8:C:N3	2:A5S:117:G:N2	2.39	0.55
2:A5S:57:U:H4'	2:A5S:58:A:O5'	2.05	0.55
2:A5S:85:G:H2'	2:A5S:86:A:C8	2.43	0.53
2:A5S:52:G:H3'	2:A5S:53:A:H8	1.74	0.53
2:A5S:17:G:H2'	2:A5S:18:U:C6	2.44	0.52
2:A5S:4:C:HO2'	2:A5S:5:C:P	2.33	0.52
2:A5S:62:C:H2'	2:A5S:63:G:C8	2.45	0.51
2:A5S:116:G:H2'	2:A5S:117:G:C8	2.44	0.51
2:A5S:75:G:H2'	2:A5S:76:G:H8	1.76	0.50
2:A5S:5:C:H2'	2:A5S:6:A:H8	1.74	0.50
2:A5S:19:G:H2'	2:A5S:20:A:H8	1.76	0.50
2:A5S:25:G:N7	2:A5S:57:U:O2'	2.43	0.50
2:A5S:6:A:N6	2:A5S:119:A:H61	2.08	0.50
2:A5S:97:C:H2'	2:A5S:98:C:C6	2.47	0.50
2:A5S:22:C:H2'	2:A5S:23:G:C8	2.47	0.49
2:A5S:82:U:H2'	2:A5S:83:G:H8	1.77	0.49
2:A5S:10:G:C2	2:A5S:116:G:C5	3.01	0.49
2:A5S:62:C:H2'	2:A5S:63:G:H8	1.77	0.49
2:A5S:20:A:H2'	2:A5S:21:G:H8	1.78	0.48
2:A5S:94:G:H2'	2:A5S:95:G:H8	1.78	0.48
2:A5S:26:U:H5'	2:A5S:27:A:C8	2.49	0.47
2:A5S:30:A:N3	2:A5S:59:A:N6	2.62	0.47
2:A5S:114:C:C4	2:A5S:115:U:C4	3.02	0.47
2:A5S:92:G:H2'	2:A5S:93:A:C8	2.50	0.47
2:A5S:19:G:H2'	2:A5S:20:A:C8	2.49	0.47

Continued on next page...

Continued from previous page...

Atom-1	Atom-2	Interatomic distance (Å)	Clash overlap (Å)
2:A5S:111:G:H3'	2:A5S:112:A:H8	1.80	0.46
2:A5S:6:A:H61	2:A5S:119:A:N6	2.12	0.46
2:A5S:84:G:H1	2:A5S:98:C:N4	2.14	0.46
2:A5S:18:U:H2'	2:A5S:19:G:H8	1.81	0.45
2:A5S:18:U:H2'	2:A5S:19:G:C8	2.51	0.45
2:A5S:64:C:H2'	2:A5S:65:U:C6	2.52	0.45
2:A5S:121:G:H2'	2:A5S:122:G:C8	2.52	0.45
2:A5S:51:G:H2'	2:A5S:52:G:O4'	2.17	0.45
2:A5S:4:C:N4	2:A5S:122:G:O6	2.47	0.45
2:A5S:100:G:C6	2:A5S:101:C:C4	3.05	0.44
2:A5S:3:C:H2'	2:A5S:4:C:C6	2.53	0.44
2:A5S:81:G:H2'	2:A5S:82:U:H6	1.82	0.44
2:A5S:35:G:O2'	2:A5S:36:A:N7	2.51	0.43
2:A5S:83:G:C4	2:A5S:100:G:C2	3.06	0.43
2:A5S:4:C:O2'	2:A5S:5:C:O5'	2.36	0.43
2:A5S:64:C:H2'	2:A5S:65:U:H6	1.83	0.43
2:A5S:79:C:H2'	2:A5S:80:C:C6	2.54	0.43
2:A5S:89:C:H2'	2:A5S:90:G:H8	1.84	0.43
2:A5S:40:G:H2'	2:A5S:41:U:C6	2.53	0.43
2:A5S:15:U:H1'	2:A5S:112:A:O2'	2.19	0.42
2:A5S:59:A:H3'	2:A5S:60:G:H8	1.83	0.42
2:A5S:54:A:H2'	2:A5S:55:G:O4'	2.19	0.42
2:A5S:76:G:C2	2:A5S:107:C:C2	3.08	0.42
2:A5S:20:A:H2'	2:A5S:21:G:C8	2.54	0.42
2:A5S:35:G:C6	2:A5S:45:G:C4	3.07	0.42
2:A5S:30:A:H2'	2:A5S:31:C:O4'	2.20	0.42
2:A5S:23:G:C6	2:A5S:63:G:C6	3.08	0.41
2:A5S:6:A:H5'	2:A5S:62:C:H4'	2.02	0.41
2:A5S:84:G:H1	2:A5S:98:C:H42	1.68	0.41
2:A5S:49:C:H2'	2:A5S:50:C:C6	2.55	0.41
2:A5S:85:G:H2'	2:A5S:86:A:H8	1.85	0.41
2:A5S:94:G:C2	2:A5S:95:G:C4	3.09	0.41
2:A5S:1:U:H3'	2:A5S:2:G:C8	2.56	0.41
2:A5S:10:G:H2'	2:A5S:11:G:H8	1.85	0.41
2:A5S:94:G:H2'	2:A5S:95:G:C8	2.54	0.41
2:A5S:113:G:HO2'	2:A5S:114:C:P	2.44	0.41
2:A5S:83:G:C6	2:A5S:100:G:C6	3.09	0.41
2:A5S:111:G:C6	2:A5S:112:A:C6	3.10	0.40

There are no symmetry-related clashes.

5.3 Torsion angles

5.3.1 Protein backbone

In the following table, the Percentiles column shows the percent Ramachandran outliers of the chain as a percentile score with respect to all PDB entries followed by that with respect to all EM entries.

The Analysed column shows the number of residues for which the backbone conformation was analysed, and the total number of residues.

Mol	Chain	Analysed	Favoured	Allowed	Outliers	Percentiles	
3	AL2P	232/234 (99%)	218 (94%)	14 (6%)	0	100	100
4	AL3P	337/339 (99%)	287 (85%)	49 (14%)	1 (0%)	41	76
5	AL4P	249/251 (99%)	213 (86%)	36 (14%)	0	100	100
6	AL5P	166/168 (99%)	154 (93%)	12 (7%)	0	100	100
7	AL6P	179/181 (99%)	166 (93%)	13 (7%)	0	100	100
8	ALX0	74/76 (97%)	63 (85%)	11 (15%)	0	100	100
9	L10E	162/164 (99%)	146 (90%)	16 (10%)	0	100	100
10	L13P	138/140 (99%)	124 (90%)	14 (10%)	0	100	100
11	L141	84/86 (98%)	70 (83%)	14 (17%)	0	100	100
11	L142	84/86 (98%)	72 (86%)	12 (14%)	0	100	100
12	L14P	132/134 (98%)	115 (87%)	17 (13%)	0	100	100
13	L15E	167/169 (99%)	153 (92%)	14 (8%)	0	100	100
14	L18E	110/112 (98%)	105 (96%)	5 (4%)	0	100	100
15	L18P	191/193 (99%)	178 (93%)	13 (7%)	0	100	100
16	L19E	142/144 (99%)	130 (92%)	12 (8%)	0	100	100
17	L22P	148/150 (99%)	126 (85%)	21 (14%)	1 (1%)	22	62
18	L23P	79/81 (98%)	70 (89%)	8 (10%)	1 (1%)	12	48
19	L24E	52/54 (96%)	46 (88%)	6 (12%)	0	100	100
20	L24P	120/122 (98%)	106 (88%)	14 (12%)	0	100	100
21	L29P	61/63 (97%)	55 (90%)	6 (10%)	0	100	100
22	L30E	92/94 (98%)	89 (97%)	3 (3%)	0	100	100
23	L30P	153/155 (99%)	129 (84%)	24 (16%)	0	100	100
24	L31E	73/75 (97%)	59 (81%)	14 (19%)	0	100	100
25	L32E	121/123 (98%)	102 (84%)	19 (16%)	0	100	100
26	L34E	75/77 (97%)	51 (68%)	22 (29%)	2 (3%)	5	33

Continued on next page...

Continued from previous page...

Mol	Chain	Analysed	Favoured	Allowed	Outliers	Percentiles	
27	L37A	63/65 (97%)	51 (81%)	12 (19%)	0	100	100
28	L37E	52/54 (96%)	39 (75%)	13 (25%)	0	100	100
29	L39E	47/49 (96%)	37 (79%)	10 (21%)	0	100	100
30	L40E	53/55 (96%)	35 (66%)	18 (34%)	0	100	100
31	L44E	90/92 (98%)	86 (96%)	4 (4%)	0	100	100
32	L7A1	121/123 (98%)	113 (93%)	8 (7%)	0	100	100
32	L7A2	121/123 (98%)	113 (93%)	8 (7%)	0	100	100
33	L15P	90/144 (62%)	81 (90%)	9 (10%)	0	100	100
34	L21E	95/97 (98%)	90 (95%)	5 (5%)	0	100	100
35	L45A	99/101 (98%)	77 (78%)	18 (18%)	4 (4%)	3	25
36	L46A	68/70 (97%)	57 (84%)	11 (16%)	0	100	100
37	L47A	78/80 (98%)	72 (92%)	6 (8%)	0	100	100
All	All	4398/4524 (97%)	3878 (88%)	511 (12%)	9 (0%)	50	81

All (9) Ramachandran outliers are listed below:

Mol	Chain	Res	Type
4	AL3P	231	ARG
35	L45A	4	VAL
35	L45A	55	VAL
35	L45A	67	THR
26	L34E	35	ALA
35	L45A	85	LYS
18	L23P	29	ASN
26	L34E	19	PRO
17	L22P	7	PRO

5.3.2 Protein sidechains [i](#)

In the following table, the Percentiles column shows the percent sidechain outliers of the chain as a percentile score with respect to all PDB entries followed by that with respect to all EM entries.

The Analysed column shows the number of residues for which the sidechain conformation was analysed, and the total number of residues.

Continued on next page...

Continued from previous page...

Mol	Chain	Analysed	Rotameric	Outliers	Percentiles	
3	AL2P	181/181 (100%)	180 (99%)	1 (1%)	86	92
4	AL3P	297/297 (100%)	294 (99%)	3 (1%)	76	86
5	AL4P	212/212 (100%)	212 (100%)	0	100	100
6	AL5P	144/144 (100%)	144 (100%)	0	100	100
7	AL6P	157/157 (100%)	156 (99%)	1 (1%)	86	92
8	ALX0	68/68 (100%)	68 (100%)	0	100	100
9	L10E	137/137 (100%)	136 (99%)	1 (1%)	84	90
10	L13P	121/121 (100%)	119 (98%)	2 (2%)	60	78
11	L141	74/74 (100%)	74 (100%)	0	100	100
11	L142	74/74 (100%)	73 (99%)	1 (1%)	67	81
12	L14P	110/110 (100%)	110 (100%)	0	100	100
13	L15E	146/146 (100%)	146 (100%)	0	100	100
14	L18E	98/98 (100%)	97 (99%)	1 (1%)	76	86
15	L18P	162/162 (100%)	161 (99%)	1 (1%)	86	92
16	L19E	126/126 (100%)	126 (100%)	0	100	100
17	L22P	131/131 (100%)	129 (98%)	2 (2%)	65	80
18	L23P	74/74 (100%)	74 (100%)	0	100	100
19	L24E	50/50 (100%)	50 (100%)	0	100	100
20	L24P	108/108 (100%)	107 (99%)	1 (1%)	78	88
21	L29P	59/59 (100%)	58 (98%)	1 (2%)	60	78
22	L30E	83/83 (100%)	82 (99%)	1 (1%)	71	84
23	L30P	136/136 (100%)	136 (100%)	0	100	100
24	L31E	66/66 (100%)	66 (100%)	0	100	100
25	L32E	106/106 (100%)	106 (100%)	0	100	100
26	L34E	70/70 (100%)	69 (99%)	1 (1%)	67	81
27	L37A	53/53 (100%)	53 (100%)	0	100	100
28	L37E	45/45 (100%)	45 (100%)	0	100	100
29	L39E	44/44 (100%)	44 (100%)	0	100	100
30	L40E	50/50 (100%)	50 (100%)	0	100	100
31	L44E	84/84 (100%)	84 (100%)	0	100	100

Continued on next page...

Continued from previous page...

Mol	Chain	Analysed	Rotameric	Outliers	Percentiles	
32	L7A1	104/104 (100%)	104 (100%)	0	100	100
32	L7A2	104/104 (100%)	102 (98%)	2 (2%)	57	75
33	L15P	78/118 (66%)	78 (100%)	0	100	100
34	L21E	85/85 (100%)	85 (100%)	0	100	100
35	L45A	91/91 (100%)	90 (99%)	1 (1%)	73	85
36	L46A	66/66 (100%)	64 (97%)	2 (3%)	41	63
37	L47A	74/74 (100%)	74 (100%)	0	100	100
All	All	3868/3908 (99%)	3846 (99%)	22 (1%)	86	92

All (22) residues with a non-rotameric sidechain are listed below:

Mol	Chain	Res	Type
3	AL2P	210	ARG
4	AL3P	4	ARG
4	AL3P	143	ASN
4	AL3P	264	HIS
7	AL6P	169	ARG
9	L10E	75	LYS
10	L13P	111	LYS
10	L13P	128	ARG
11	L142	74	GLN
14	L18E	36	ARG
15	L18P	138	LYS
17	L22P	64	ARG
17	L22P	77	ARG
20	L24P	119	LYS
21	L29P	52	ILE
22	L30E	94	LYS
26	L34E	41	LYS
32	L7A2	116	LYS
32	L7A2	124	LYS
35	L45A	83	LYS
36	L46A	22	ARG
36	L46A	45	LYS

Sometimes sidechains can be flipped to improve hydrogen bonding and reduce clashes. There are no such sidechains identified.

5.3.3 RNA

Mol	Chain	Analysed	Backbone Outliers	Pucker Outliers
1	A23S	2979/3022 (98%)	739 (24%)	44 (1%)
2	A5S	121/122 (99%)	21 (17%)	1 (0%)
All	All	3100/3144 (98%)	760 (24%)	45 (1%)

All (760) RNA backbone outliers are listed below:

Mol	Chain	Res	Type
1	A23S	7	G
1	A23S	16	U
1	A23S	18	G
1	A23S	19	A
1	A23S	30	C
1	A23S	31	G
1	A23S	33	G
1	A23S	36	C
1	A23S	38	G
1	A23S	41	G
1	A23S	45	G
1	A23S	48	G
1	A23S	49	C
1	A23S	51	G
1	A23S	53	A
1	A23S	54	A
1	A23S	61	A
1	A23S	64	U
1	A23S	65	G
1	A23S	69	G
1	A23S	74	A
1	A23S	75	G
1	A23S	78	G
1	A23S	80	A
1	A23S	81	A
1	A23S	89	U
1	A23S	92	A
1	A23S	99	G
1	A23S	105	C
1	A23S	107	A
1	A23S	109	U
1	A23S	114	U
1	A23S	115	A
1	A23S	116	U
1	A23S	117	C
1	A23S	126	U

Continued on next page...

Continued from previous page...

Mol	Chain	Res	Type
1	A23S	129	C
1	A23S	131	G
1	A23S	137	C
1	A23S	144	U
1	A23S	146	U
1	A23S	147	A
1	A23S	152	G
1	A23S	157	G
1	A23S	160	A
1	A23S	166	C
1	A23S	170	A
1	A23S	175	A
1	A23S	178	A
1	A23S	192	A
1	A23S	195	A
1	A23S	196	A
1	A23S	200	A
1	A23S	201	A
1	A23S	206	A
1	A23S	207	U
1	A23S	208	U
1	A23S	209	G
1	A23S	212	A
1	A23S	220	A
1	A23S	221	G
1	A23S	222	U
1	A23S	225	G
1	A23S	227	G
1	A23S	228	C
1	A23S	229	G
1	A23S	242	A
1	A23S	243	C
1	A23S	244	A
1	A23S	245	G
1	A23S	246	C
1	A23S	255	A
1	A23S	268	U
1	A23S	276	U
1	A23S	277	G
1	A23S	281	A
1	A23S	282	U
1	A23S	288	G

Continued on next page...

Continued from previous page...

Mol	Chain	Res	Type
1	A23S	289	U
1	A23S	290	U
1	A23S	293	G
1	A23S	303	C
1	A23S	304	U
1	A23S	305	G
1	A23S	319	G
1	A23S	326	U
1	A23S	336	A
1	A23S	337	G
1	A23S	343	C
1	A23S	344	U
1	A23S	345	C
1	A23S	352	A
1	A23S	353	A
1	A23S	354	C
1	A23S	364	U
1	A23S	368	G
1	A23S	372	G
1	A23S	373	A
1	A23S	375	A
1	A23S	376	G
1	A23S	383	A
1	A23S	403	G
1	A23S	405	G
1	A23S	418	G
1	A23S	419	U
1	A23S	428	C
1	A23S	433	U
1	A23S	434	U
1	A23S	448	U
1	A23S	454	A
1	A23S	455	C
1	A23S	460	G
1	A23S	464	C
1	A23S	468	G
1	A23S	469	G
1	A23S	476	A
1	A23S	478	G
1	A23S	479	U
1	A23S	490	A
1	A23S	491	U

Continued on next page...

Continued from previous page...

Mol	Chain	Res	Type
1	A23S	492	A
1	A23S	494	C
1	A23S	499	U
1	A23S	501	A
1	A23S	502	G
1	A23S	506	C
1	A23S	509	G
1	A23S	511	G
1	A23S	517	G
1	A23S	519	U
1	A23S	521	A
1	A23S	523	A
1	A23S	524	A
1	A23S	525	G
1	A23S	535	A
1	A23S	536	G
1	A23S	547	A
1	A23S	548	A
1	A23S	549	G
1	A23S	550	A
1	A23S	551	G
1	A23S	552	C
1	A23S	553	C
1	A23S	556	A
1	A23S	566	G
1	A23S	570	U
1	A23S	572	C
1	A23S	573	A
1	A23S	574	G
1	A23S	575	G
1	A23S	580	G
1	A23S	586	A
1	A23S	589	G
1	A23S	592	G
1	A23S	594	G
1	A23S	599	C
1	A23S	621	G
1	A23S	627	A
1	A23S	628	G
1	A23S	632	G
1	A23S	633	A
1	A23S	634	G

Continued on next page...

Continued from previous page...

Mol	Chain	Res	Type
1	A23S	638	G
1	A23S	639	G
1	A23S	644	U
1	A23S	657	U
1	A23S	658	U
1	A23S	659	U
1	A23S	660	C
1	A23S	667	A
1	A23S	668	A
1	A23S	669	A
1	A23S	671	A
1	A23S	674	G
1	A23S	682	A
1	A23S	683	G
1	A23S	699	A
1	A23S	713	A
1	A23S	714	U
1	A23S	720	A
1	A23S	721	A
1	A23S	727	A
1	A23S	732	A
1	A23S	733	A
1	A23S	734	C
1	A23S	737	A
1	A23S	739	U
1	A23S	740	G
1	A23S	741	C
1	A23S	743	C
1	A23S	753	U
1	A23S	755	U
1	A23S	757	U
1	A23S	758	A
1	A23S	762	G
1	A23S	768	C
1	A23S	769	A
1	A23S	777	U
1	A23S	778	C
1	A23S	780	G
1	A23S	787	A
1	A23S	802	G
1	A23S	803	G
1	A23S	808	A

Continued on next page...

Continued from previous page...

Mol	Chain	Res	Type
1	A23S	809	A
1	A23S	810	A
1	A23S	819	U
1	A23S	844	G
1	A23S	846	G
1	A23S	847	G
1	A23S	850	A
1	A23S	851	C
1	A23S	859	G
1	A23S	863	G
1	A23S	867	A
1	A23S	868	A
1	A23S	869	U
1	A23S	878	U
1	A23S	879	G
1	A23S	883	U
1	A23S	889	U
1	A23S	895	C
1	A23S	900	A
1	A23S	901	C
1	A23S	911	G
1	A23S	912	G
1	A23S	918	A
1	A23S	920	G
1	A23S	921	A
1	A23S	924	A
1	A23S	925	A
1	A23S	927	C
1	A23S	928	U
1	A23S	935	G
1	A23S	936	U
1	A23S	938	A
1	A23S	939	U
1	A23S	941	G
1	A23S	948	C
1	A23S	963	C
1	A23S	964	C
1	A23S	966	A
1	A23S	981	A
1	A23S	996	G
1	A23S	997	U
1	A23S	1001	G

Continued on next page...

Continued from previous page...

Mol	Chain	Res	Type
1	A23S	1004	A
1	A23S	1007	G
1	A23S	1046	A
1	A23S	1048	C
1	A23S	1051	C
1	A23S	1053	A
1	A23S	1068	A
1	A23S	1069	A
1	A23S	1070	G
1	A23S	1071	A
1	A23S	1072	A
1	A23S	1073	G
1	A23S	1083	G
1	A23S	1084	G
1	A23S	1091	G
1	A23S	1096	A
1	A23S	1097	A
1	A23S	1098	G
1	A23S	1099	G
1	A23S	1107	G
1	A23S	1110	A
1	A23S	1111	A
1	A23S	1115	G
1	A23S	1117	A
1	A23S	1120	A
1	A23S	1121	A
1	A23S	1122	C
1	A23S	1136	A
1	A23S	1137	A
1	A23S	1145	A
1	A23S	1148	U
1	A23S	1149	C
1	A23S	1158	G
1	A23S	1166	G
1	A23S	1168	A
1	A23S	1174	G
1	A23S	1178	C
1	A23S	1179	C
1	A23S	1180	A
1	A23S	1183	C
1	A23S	1184	U
1	A23S	1185	U

Continued on next page...

Continued from previous page...

Mol	Chain	Res	Type
1	A23S	1187	G
1	A23S	1193	G
1	A23S	1196	A
1	A23S	1198	G
1	A23S	1199	G
1	A23S	1200	U
1	A23S	1201	G
1	A23S	1202	G
1	A23S	1203	G
1	A23S	1206	C
1	A23S	1208	G
1	A23S	1210	A
1	A23S	1211	G
1	A23S	1213	A
1	A23S	1219	C
1	A23S	1221	U
1	A23S	1222	C
1	A23S	1225	A
1	A23S	1227	G
1	A23S	1229	G
1	A23S	1233	G
1	A23S	1245	C
1	A23S	1250	G
1	A23S	1251	A
1	A23S	1252	G
1	A23S	1269	A
1	A23S	1270	U
1	A23S	1273	G
1	A23S	1275	C
1	A23S	1276	G
1	A23S	1279	G
1	A23S	1282	C
1	A23S	1283	A
1	A23S	1289	G
1	A23S	1296	A
1	A23S	1316	C
1	A23S	1317	U
1	A23S	1321	A
1	A23S	1328	C
1	A23S	1330	G
1	A23S	1332	U
1	A23S	1340	C

Continued on next page...

Continued from previous page...

Mol	Chain	Res	Type
1	A23S	1344	G
1	A23S	1347	A
1	A23S	1350	G
1	A23S	1351	G
1	A23S	1353	U
1	A23S	1354	A
1	A23S	1355	G
1	A23S	1356	A
1	A23S	1370	G
1	A23S	1381	C
1	A23S	1394	C
1	A23S	1395	A
1	A23S	1396	G
1	A23S	1397	A
1	A23S	1398	U
1	A23S	1399	C
1	A23S	1409	G
1	A23S	1417	G
1	A23S	1420	G
1	A23S	1430	A
1	A23S	1440	G
1	A23S	1444	G
1	A23S	1445	A
1	A23S	1446	A
1	A23S	1452	A
1	A23S	1453	G
1	A23S	1457	U
1	A23S	1458	U
1	A23S	1465	A
1	A23S	1468	G
1	A23S	1469	U
1	A23S	1473	U
1	A23S	1474	C
1	A23S	1477	C
1	A23S	1484	U
1	A23S	1485	U
1	A23S	1491	U
1	A23S	1497	G
1	A23S	1501	A
1	A23S	1504	G
1	A23S	1505	C
1	A23S	1510	U

Continued on next page...

Continued from previous page...

Mol	Chain	Res	Type
1	A23S	1515	A
1	A23S	1523	A
1	A23S	1525	A
1	A23S	1529	A
1	A23S	1530	A
1	A23S	1532	G
1	A23S	1534	G
1	A23S	1539	A
1	A23S	1540	C
1	A23S	1541	A
1	A23S	1542	U
1	A23S	1549	G
1	A23S	1561	G
1	A23S	1562	G
1	A23S	1564	G
1	A23S	1565	C
1	A23S	1570	A
1	A23S	1571	C
1	A23S	1574	A
1	A23S	1575	A
1	A23S	1576	G
1	A23S	1579	A
1	A23S	1580	G
1	A23S	1581	A
1	A23S	1585	C
1	A23S	1586	U
1	A23S	1587	G
1	A23S	1589	C
1	A23S	1590	G
1	A23S	1602	G
1	A23S	1603	G
1	A23S	1609	A
1	A23S	1613	C
1	A23S	1614	C
1	A23S	1615	A
1	A23S	1616	C
1	A23S	1617	C
1	A23S	1623	A
1	A23S	1625	C
1	A23S	1626	C
1	A23S	1634	C
1	A23S	1635	A

Continued on next page...

Continued from previous page...

Mol	Chain	Res	Type
1	A23S	1636	A
1	A23S	1644	G
1	A23S	1645	A
1	A23S	1646	G
1	A23S	1647	A
1	A23S	1648	G
1	A23S	1653	A
1	A23S	1659	G
1	A23S	1661	G
1	A23S	1666	G
1	A23S	1667	G
1	A23S	1670	G
1	A23S	1673	G
1	A23S	1676	G
1	A23S	1680	U
1	A23S	1681	G
1	A23S	1682	G
1	A23S	1683	G
1	A23S	1684	C
1	A23S	1690	G
1	A23S	1691	U
1	A23S	1692	U
1	A23S	1693	A
1	A23S	1701	U
1	A23S	1707	G
1	A23S	1708	A
1	A23S	1709	U
1	A23S	1710	C
1	A23S	1711	C
1	A23S	1713	U
1	A23S	1715	G
1	A23S	1720	C
1	A23S	1721	A
1	A23S	1722	U
1	A23S	1724	A
1	A23S	1726	A
1	A23S	1734	C
1	A23S	1740	C
1	A23S	1741	G
1	A23S	1743	U
1	A23S	1744	C
1	A23S	1745	C

Continued on next page...

Continued from previous page...

Mol	Chain	Res	Type
1	A23S	1751	G
1	A23S	1752	A
1	A23S	1756	U
1	A23S	1757	A
1	A23S	1759	C
1	A23S	1760	U
1	A23S	1761	A
1	A23S	1762	G
1	A23S	1763	A
1	A23S	1764	A
1	A23S	1765	C
1	A23S	1770	A
1	A23S	1771	C
1	A23S	1773	G
1	A23S	1776	G
1	A23S	1777	C
1	A23S	1786	G
1	A23S	1789	A
1	A23S	1801	U
1	A23S	1802	C
1	A23S	1804	G
1	A23S	1810	U
1	A23S	1811	A
1	A23S	1817	G
1	A23S	1825	A
1	A23S	1828	U
1	A23S	1856	G
1	A23S	1857	A
1	A23S	1868	A
1	A23S	1869	U
1	A23S	1877	U
1	A23S	1882	A
1	A23S	1883	A
1	A23S	1900	G
1	A23S	1907	G
1	A23S	1908	A
1	A23S	1917	A
1	A23S	1923	U
1	A23S	1924	A
1	A23S	1925	A
1	A23S	1927	A
1	A23S	1931	A

Continued on next page...

Continued from previous page...

Mol	Chain	Res	Type
1	A23S	1935	A
1	A23S	1944	C
1	A23S	1949	C
1	A23S	1953	A
1	A23S	1955	G
1	A23S	1958	U
1	A23S	1959	G
1	A23S	1961	G
1	A23S	1969	G
1	A23S	1970	C
1	A23S	1972	A
1	A23S	1973	A
1	A23S	1977	C
1	A23S	1978	U
1	A23S	1992	U
1	A23S	1993	G
1	A23S	2007	U
1	A23S	2030	A
1	A23S	2032	G
1	A23S	2035	G
1	A23S	2054	U
1	A23S	2055	U
1	A23S	2056	A
1	A23S	2059	G
1	A23S	2066	A
1	A23S	2069	G
1	A23S	2072	U
1	A23S	2073	U
1	A23S	2084	U
1	A23S	2092	C
1	A23S	2093	G
1	A23S	2096	U
1	A23S	2099	A
1	A23S	2100	U
1	A23S	2101	G
1	A23S	2105	C
1	A23S	2122	U
1	A23S	2125	C
1	A23S	2147	C
1	A23S	2148	C
1	A23S	2149	U
1	A23S	2150	G

Continued on next page...

Continued from previous page...

Mol	Chain	Res	Type
1	A23S	2151	A
1	A23S	2152	G
1	A23S	2155	G
1	A23S	2159	C
1	A23S	2160	A
1	A23S	2161	C
1	A23S	2162	A
1	A23S	2165	C
1	A23S	2170	A
1	A23S	2180	A
1	A23S	2181	C
1	A23S	2184	A
1	A23S	2189	A
1	A23S	2190	G
1	A23S	2191	A
1	A23S	2192	C
1	A23S	2197	U
1	A23S	2198	G
1	A23S	2206	A
1	A23S	2208	C
1	A23S	2209	G
1	A23S	2221	U
1	A23S	2222	G
1	A23S	2225	C
1	A23S	2226	C
1	A23S	2231	G
1	A23S	2236	U
1	A23S	2237	A
1	A23S	2238	U
1	A23S	2239	G
1	A23S	2240	C
1	A23S	2241	G
1	A23S	2244	G
1	A23S	2245	A
1	A23S	2247	U
1	A23S	2252	G
1	A23S	2255	A
1	A23S	2257	G
1	A23S	2258	G
1	A23S	2260	U
1	A23S	2261	C
1	A23S	2262	G

Continued on next page...

Continued from previous page...

Mol	Chain	Res	Type
1	A23S	2266	C
1	A23S	2270	C
1	A23S	2275	C
1	A23S	2286	G
1	A23S	2287	A
1	A23S	2288	C
1	A23S	2290	C
1	A23S	2292	A
1	A23S	2293	A
1	A23S	2297	G
1	A23S	2298	A
1	A23S	2299	A
1	A23S	2300	A
1	A23S	2320	A
1	A23S	2321	G
1	A23S	2327	A
1	A23S	2328	A
1	A23S	2337	A
1	A23S	2346	A
1	A23S	2359	G
1	A23S	2367	G
1	A23S	2371	G
1	A23S	2390	A
1	A23S	2401	G
1	A23S	2405	C
1	A23S	2408	A
1	A23S	2409	A
1	A23S	2426	U
1	A23S	2427	A
1	A23S	2428	C
1	A23S	2429	A
1	A23S	2430	G
1	A23S	2431	A
1	A23S	2434	G
1	A23S	2441	U
1	A23S	2442	A
1	A23S	2444	A
1	A23S	2449	A
1	A23S	2457	A
1	A23S	2467	G
1	A23S	2492	C
1	A23S	2500	G

Continued on next page...

Continued from previous page...

Mol	Chain	Res	Type
1	A23S	2503	A
1	A23S	2505	C
1	A23S	2507	G
1	A23S	2508	G
1	A23S	2526	G
1	A23S	2527	C
1	A23S	2531	C
1	A23S	2532	A
1	A23S	2533	C
1	A23S	2545	G
1	A23S	2551	G
1	A23S	2555	G
1	A23S	2556	A
1	A23S	2559	A
1	A23S	2563	A
1	A23S	2565	C
1	A23S	2571	G
1	A23S	2572	A
1	A23S	2573	U
1	A23S	2578	G
1	A23S	2583	G
1	A23S	2593	A
1	A23S	2596	G
1	A23S	2599	C
1	A23S	2600	A
1	A23S	2602	A
1	A23S	2605	G
1	A23S	2616	U
1	A23S	2621	A
1	A23S	2622	C
1	A23S	2623	A
1	A23S	2627	A
1	A23S	2642	A
1	A23S	2644	C
1	A23S	2653	G
1	A23S	2659	G
1	A23S	2671	A
1	A23S	2678	C
1	A23S	2687	U
1	A23S	2688	A
1	A23S	2690	A
1	A23S	2691	G

Continued on next page...

Continued from previous page...

Mol	Chain	Res	Type
1	A23S	2696	G
1	A23S	2697	C
1	A23S	2702	G
1	A23S	2704	U
1	A23S	2709	U
1	A23S	2710	U
1	A23S	2721	G
1	A23S	2722	A
1	A23S	2723	G
1	A23S	2726	A
1	A23S	2727	G
1	A23S	2737	U
1	A23S	2738	A
1	A23S	2753	G
1	A23S	2754	G
1	A23S	2756	C
1	A23S	2761	U
1	A23S	2762	G
1	A23S	2763	A
1	A23S	2764	G
1	A23S	2769	A
1	A23S	2770	G
1	A23S	2787	A
1	A23S	2795	G
1	A23S	2814	U
1	A23S	2815	A
1	A23S	2835	A
1	A23S	2836	U
1	A23S	2837	G
1	A23S	2847	C
1	A23S	2848	G
1	A23S	2849	C
1	A23S	2855	G
1	A23S	2856	A
1	A23S	2870	A
1	A23S	2872	A
1	A23S	2873	G
1	A23S	2879	A
1	A23S	2880	A
1	A23S	2886	A
1	A23S	2887	A
1	A23S	2888	C

Continued on next page...

Continued from previous page...

Mol	Chain	Res	Type
1	A23S	2889	C
1	A23S	2891	C
1	A23S	2896	C
1	A23S	2898	A
1	A23S	2899	A
1	A23S	2900	A
1	A23S	2902	G
1	A23S	2924	G
1	A23S	2934	U
1	A23S	2937	A
1	A23S	2939	G
1	A23S	2940	A
1	A23S	2947	U
1	A23S	2948	G
1	A23S	2950	U
1	A23S	2960	A
1	A23S	2961	U
1	A23S	2973	G
1	A23S	2983	C
1	A23S	2987	G
1	A23S	2992	U
1	A23S	2993	U
1	A23S	2994	A
1	A23S	2999	G
1	A23S	3000	C
1	A23S	3005	C
1	A23S	3006	C
1	A23S	3017	C
1	A23S	3019	C
1	A23S	3020	C
1	A23S	3021	C
2	A5S	5	C
2	A5S	10	G
2	A5S	25	G
2	A5S	27	A
2	A5S	36	A
2	A5S	42	U
2	A5S	43	U
2	A5S	45	G
2	A5S	46	A
2	A5S	52	G
2	A5S	58	A

Continued on next page...

Continued from previous page...

Mol	Chain	Res	Type
2	A5S	59	A
2	A5S	68	C
2	A5S	88	C
2	A5S	93	A
2	A5S	102	A
2	A5S	107	C
2	A5S	113	G
2	A5S	114	C
2	A5S	118	G
2	A5S	119	A

All (45) RNA pucker outliers are listed below:

Mol	Chain	Res	Type
1	A23S	113	A
1	A23S	136	U
1	A23S	280	G
1	A23S	336	A
1	A23S	382	U
1	A23S	402	A
1	A23S	404	U
1	A23S	574	G
1	A23S	658	U
1	A23S	667	A
1	A23S	668	A
1	A23S	740	G
1	A23S	808	A
1	A23S	920	G
1	A23S	1003	G
1	A23S	1177	U
1	A23S	1179	C
1	A23S	1198	G
1	A23S	1250	G
1	A23S	1295	G
1	A23S	1327	U
1	A23S	1408	A
1	A23S	1490	G
1	A23S	1500	U
1	A23S	1529	A
1	A23S	1539	A
1	A23S	1625	C
1	A23S	1626	C

Continued on next page...

Continued from previous page...

Mol	Chain	Res	Type
1	A23S	1646	G
1	A23S	1647	A
1	A23S	1706	U
1	A23S	1750	A
1	A23S	1751	G
1	A23S	1760	U
1	A23S	1934	U
1	A23S	2098	A
1	A23S	2099	A
1	A23S	2146	C
1	A23S	2256	G
1	A23S	2429	A
1	A23S	2504	G
1	A23S	2835	A
1	A23S	2878	U
1	A23S	2923	G
2	A5S	57	U

5.4 Non-standard residues in protein, DNA, RNA chains [i](#)

There are no non-standard protein/DNA/RNA residues in this entry.

5.5 Carbohydrates [i](#)

There are no monosaccharides in this entry.

5.6 Ligand geometry [i](#)

There are no ligands in this entry.

5.7 Other polymers [i](#)

There are no such residues in this entry.

5.8 Polymer linkage issues [i](#)

There are no chain breaks in this entry.

6 Map visualisation [i](#)

This section contains visualisations of the EMDB entry EMD-34861. These allow visual inspection of the internal detail of the map and identification of artifacts.

Images derived from a raw map, generated by summing the deposited half-maps, are presented below the corresponding image components of the primary map to allow further visual inspection and comparison with those of the primary map.

6.1 Orthogonal projections [i](#)

6.1.1 Primary map

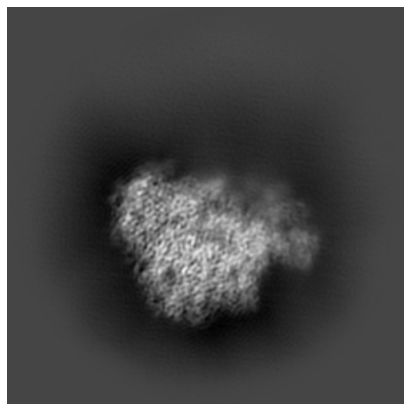

X

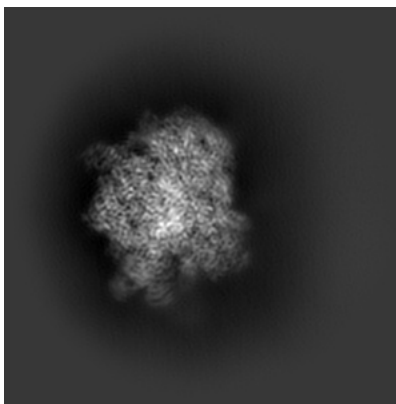

Y

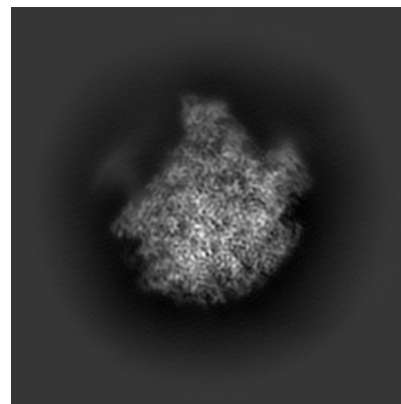

Z

6.1.2 Raw map

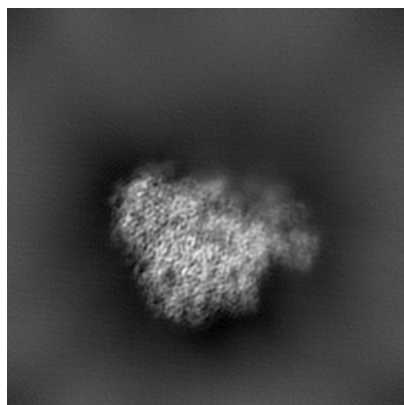

X

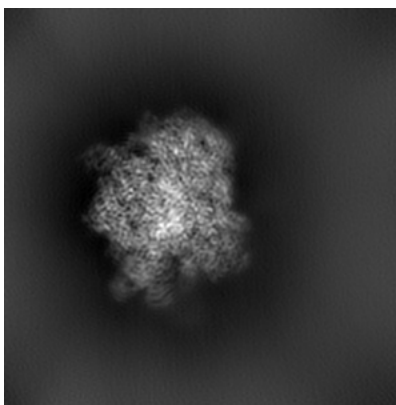

Y

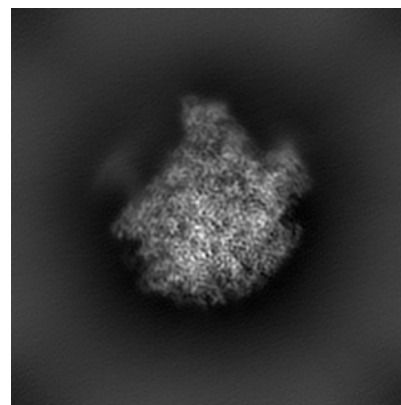

Z

The images above show the map projected in three orthogonal directions.

6.2 Central slices [i](#)

6.2.1 Primary map

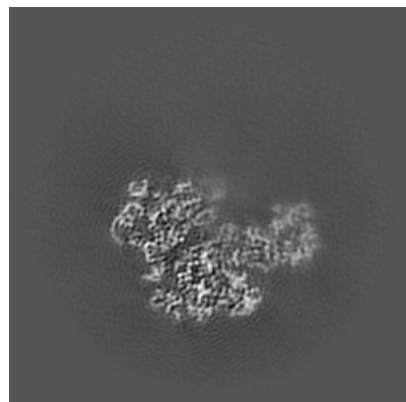

X Index: 90

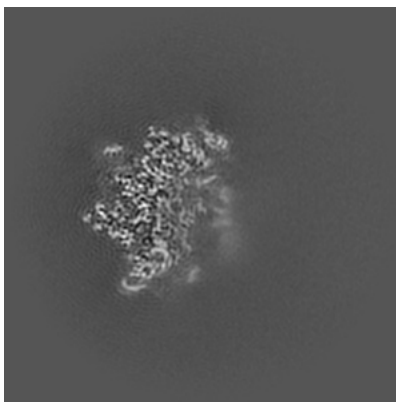

Y Index: 90

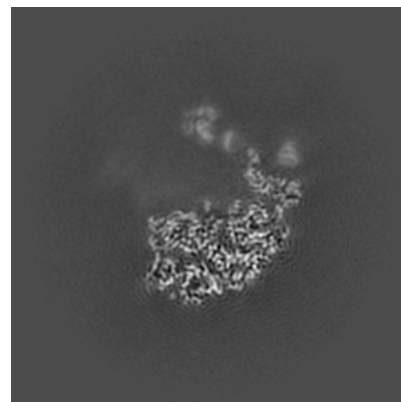

Z Index: 90

6.2.2 Raw map

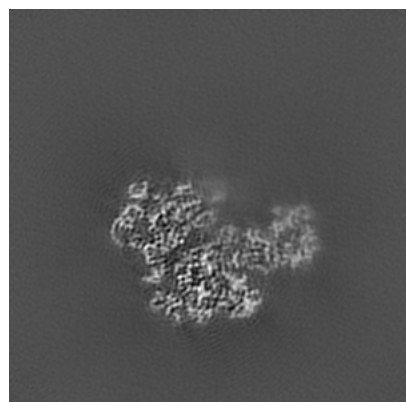

X Index: 90

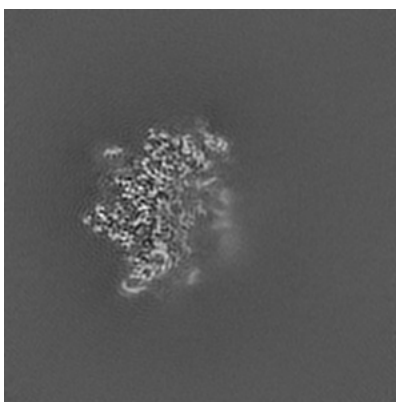

Y Index: 90

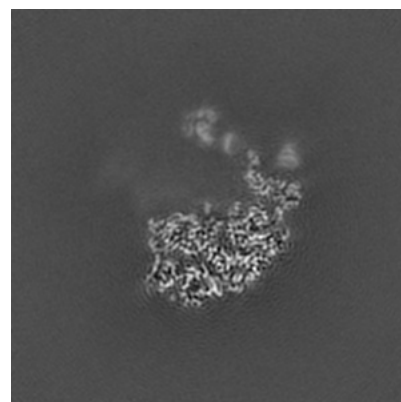

Z Index: 90

The images above show central slices of the map in three orthogonal directions.

6.3 Largest variance slices [i](#)

6.3.1 Primary map

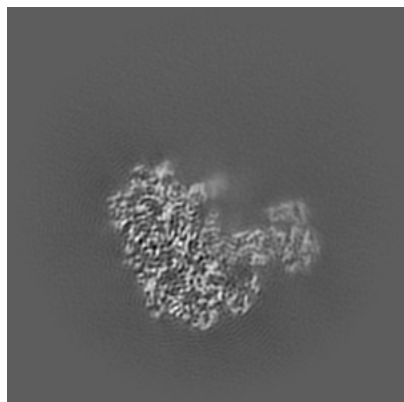

X Index: 84

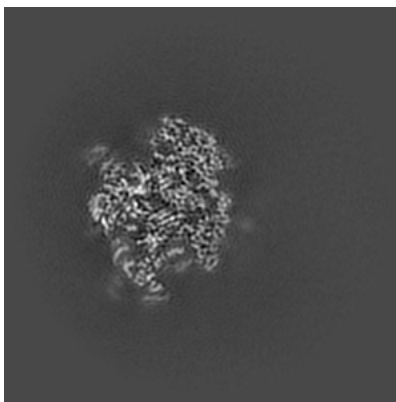

Y Index: 76

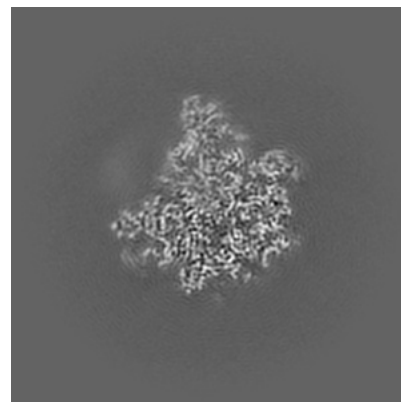

Z Index: 70

6.3.2 Raw map

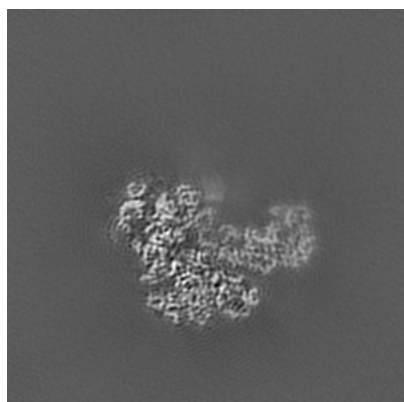

X Index: 89

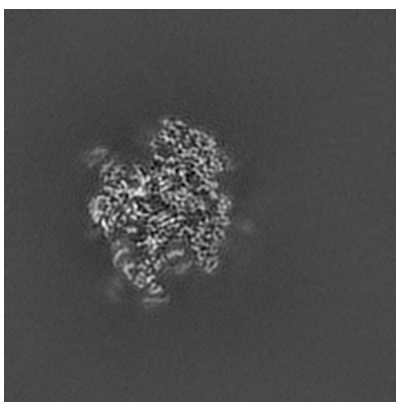

Y Index: 76

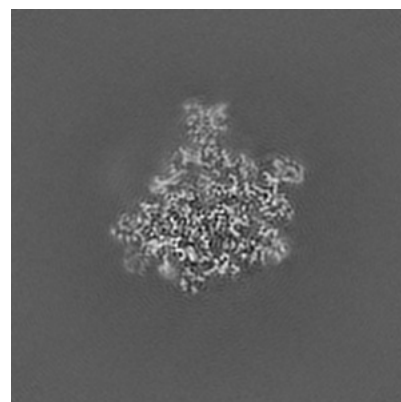

Z Index: 67

The images above show the largest variance slices of the map in three orthogonal directions.

6.4 Orthogonal standard-deviation projections (False-color) [i](#)

6.4.1 Primary map

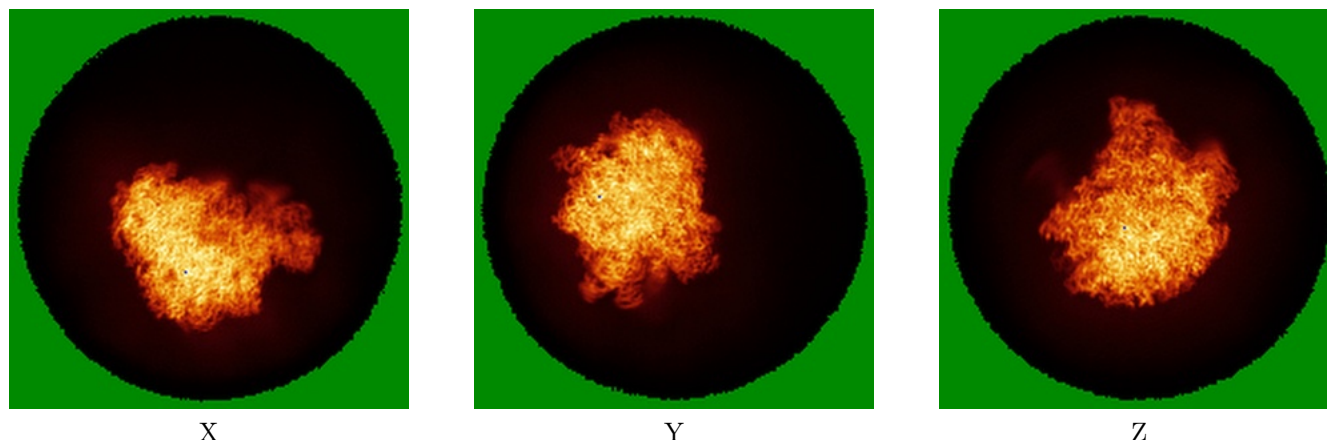

6.4.2 Raw map

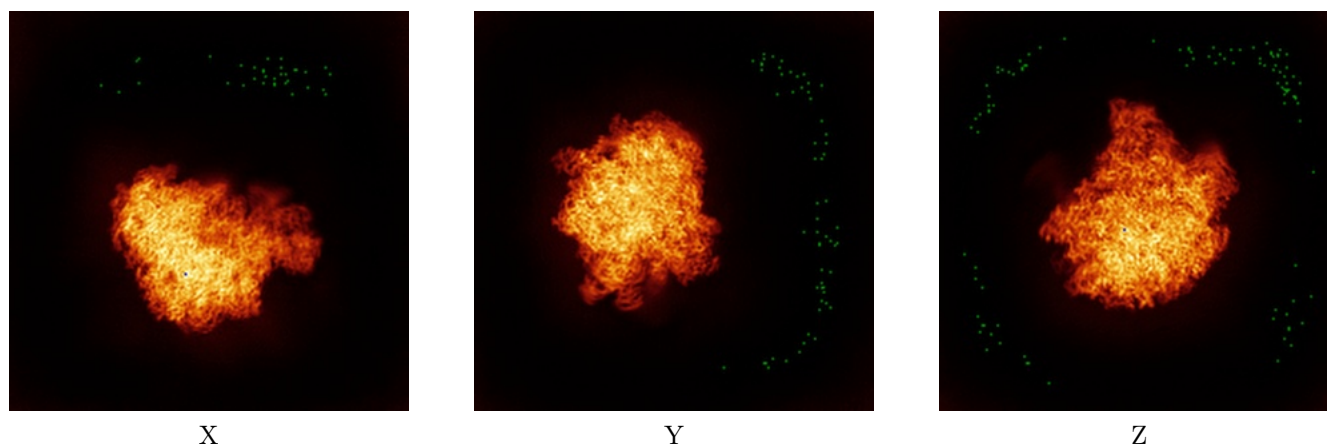

The images above show the map standard deviation projections with false color in three orthogonal directions. Minimum values are shown in green, max in blue, and dark to light orange shades represent small to large values respectively.

6.5 Orthogonal surface views [i](#)

6.5.1 Primary map



The images above show the 3D surface view of the map at the recommended contour level 0.69. These images, in conjunction with the slice images, may facilitate assessment of whether an appropriate contour level has been provided.

6.5.2 Raw map



These images show the 3D surface of the raw map. The raw map's contour level was selected so that its surface encloses the same volume as the primary map does at its recommended contour level.

6.6 Mask visualisation [i](#)

This section was not generated. No masks/segmentation were deposited.

7 Map analysis [i](#)

This section contains the results of statistical analysis of the map.

7.1 Map-value distribution [i](#)

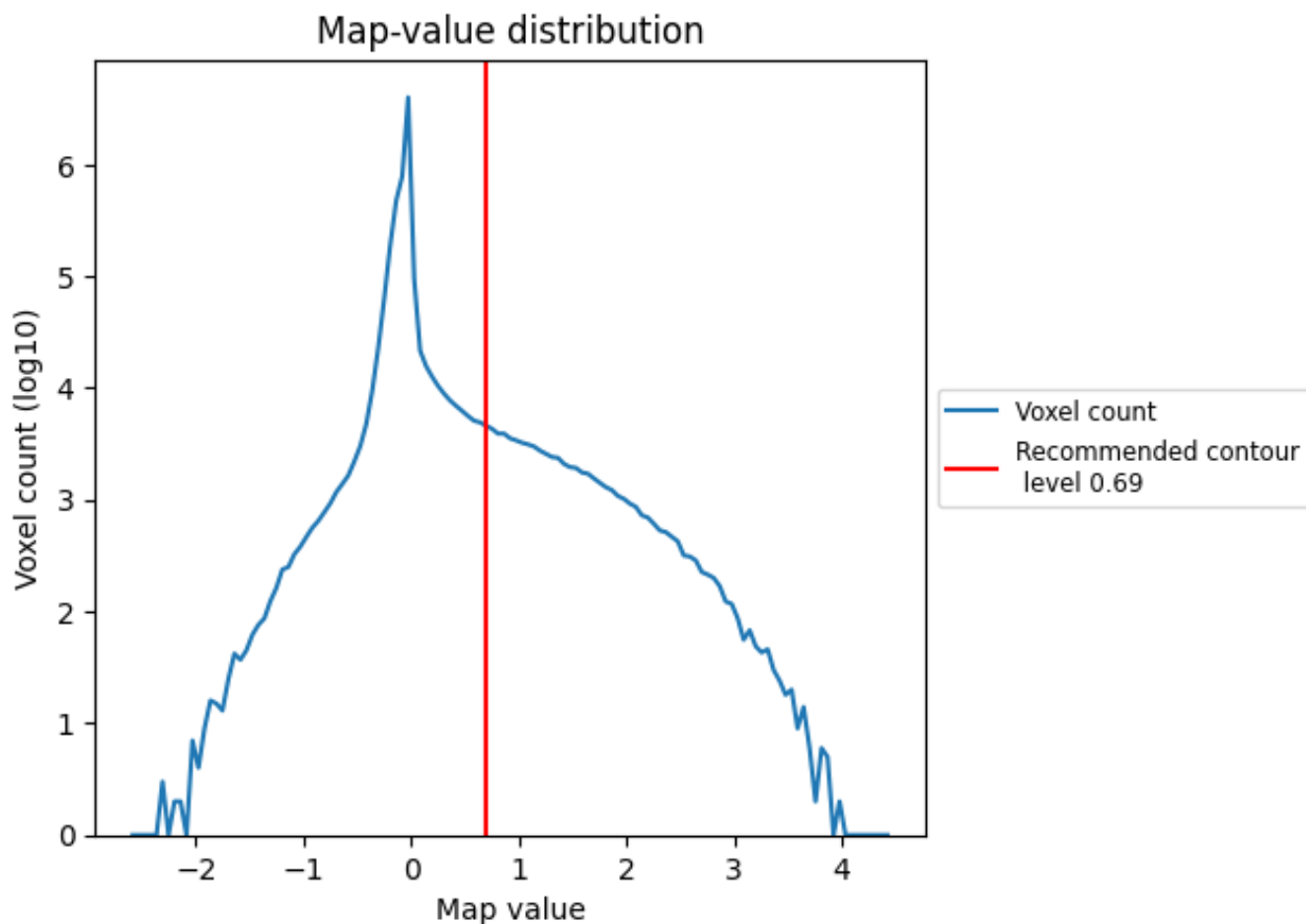

The map-value distribution is plotted in 128 intervals along the x-axis. The y-axis is logarithmic. A spike in this graph at zero usually indicates that the volume has been masked.

7.2 Volume estimate [i](#)

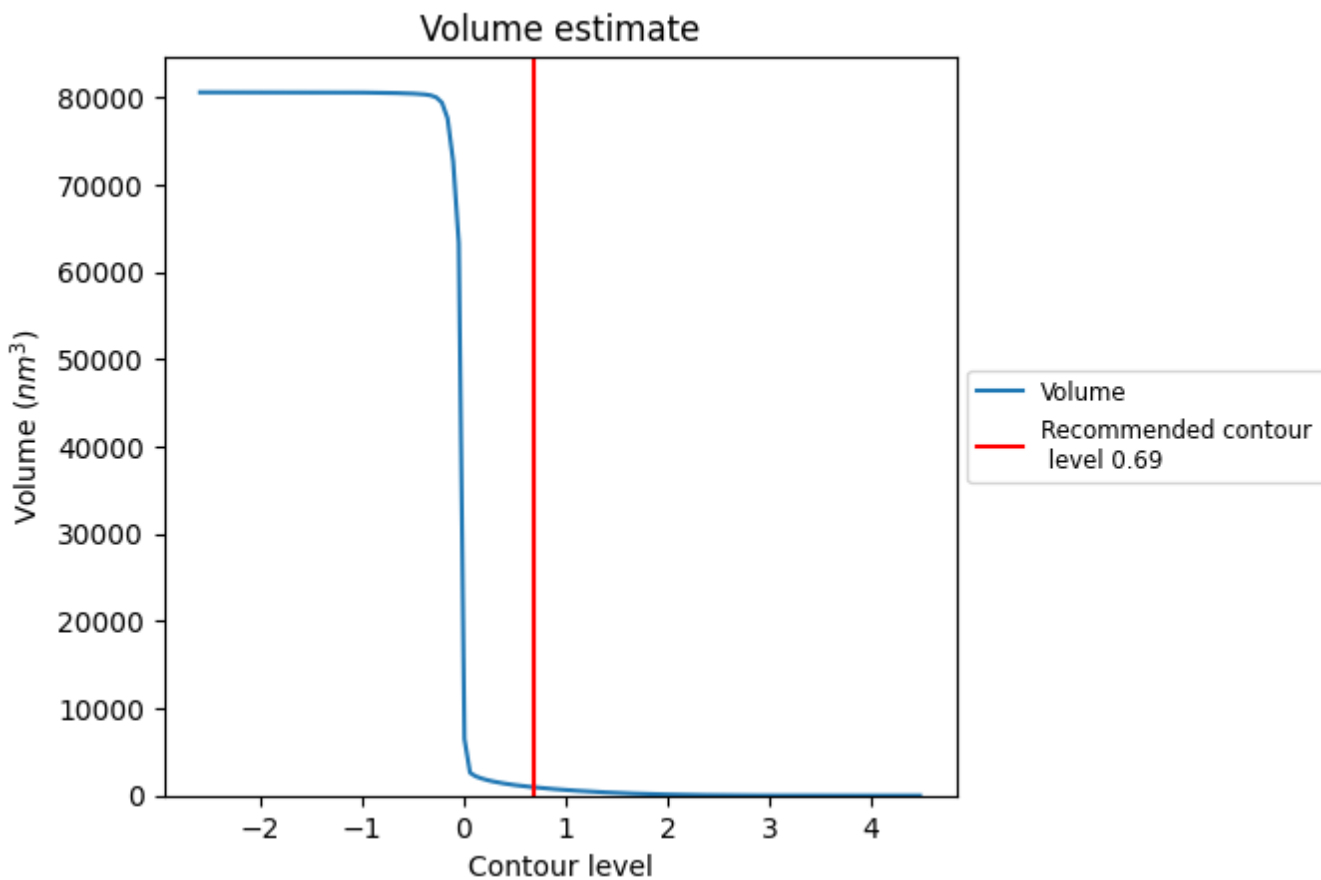

The volume at the recommended contour level is 953 nm³; this corresponds to an approximate mass of 861 kDa.

The volume estimate graph shows how the enclosed volume varies with the contour level. The recommended contour level is shown as a vertical line and the intersection between the line and the curve gives the volume of the enclosed surface at the given level.

7.3 Rotationally averaged power spectrum i

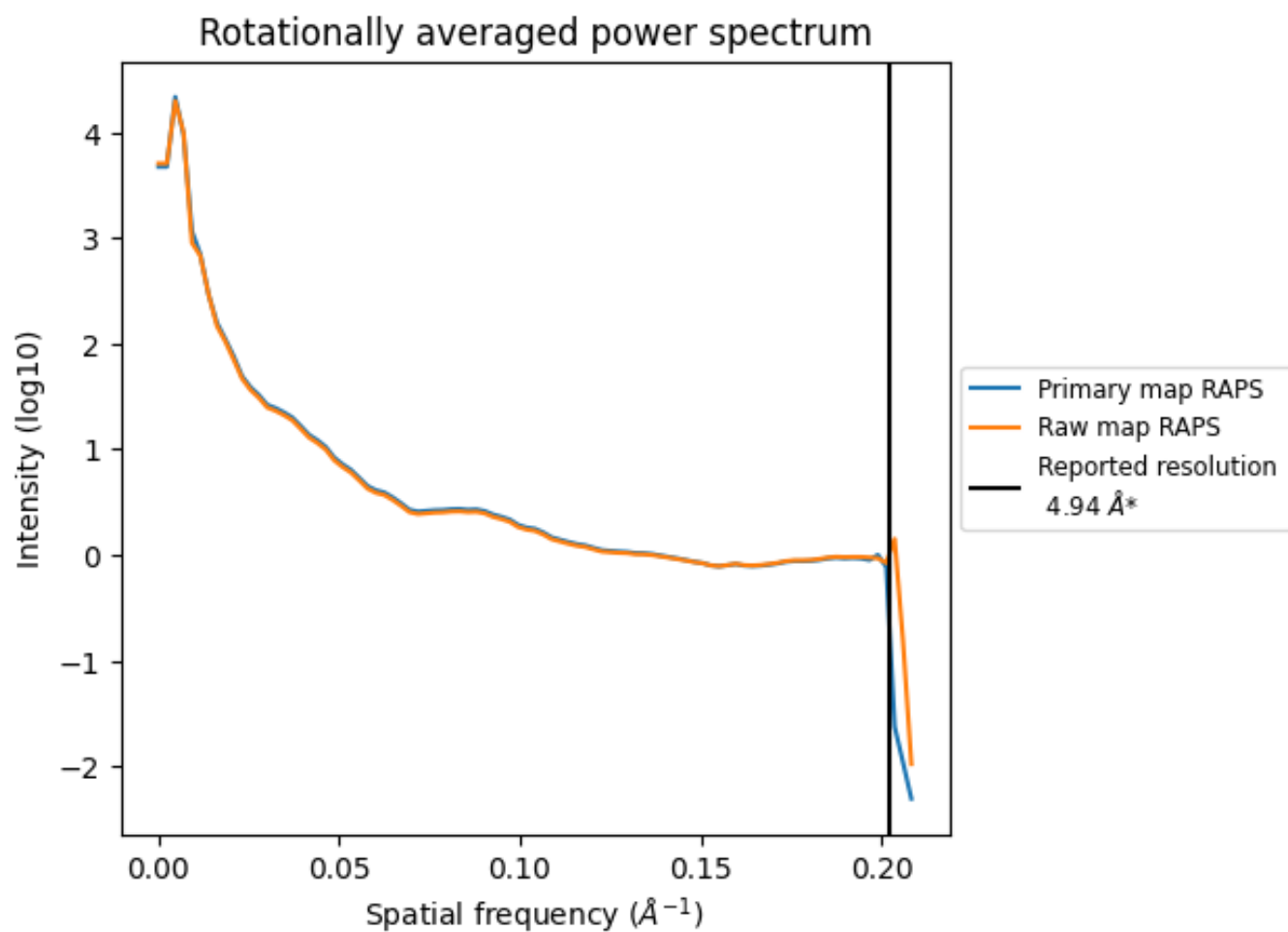

*Reported resolution corresponds to spatial frequency of 0.202 Å⁻¹

8 Fourier-Shell correlation [i](#)

Fourier-Shell Correlation (FSC) is the most commonly used method to estimate the resolution of single-particle and subtomogram-averaged maps. The shape of the curve depends on the imposed symmetry, mask and whether or not the two 3D reconstructions used were processed from a common reference. The reported resolution is shown as a black line. A curve is displayed for the half-bit criterion in addition to lines showing the 0.143 gold standard cut-off and 0.5 cut-off.

8.1 FSC [i](#)

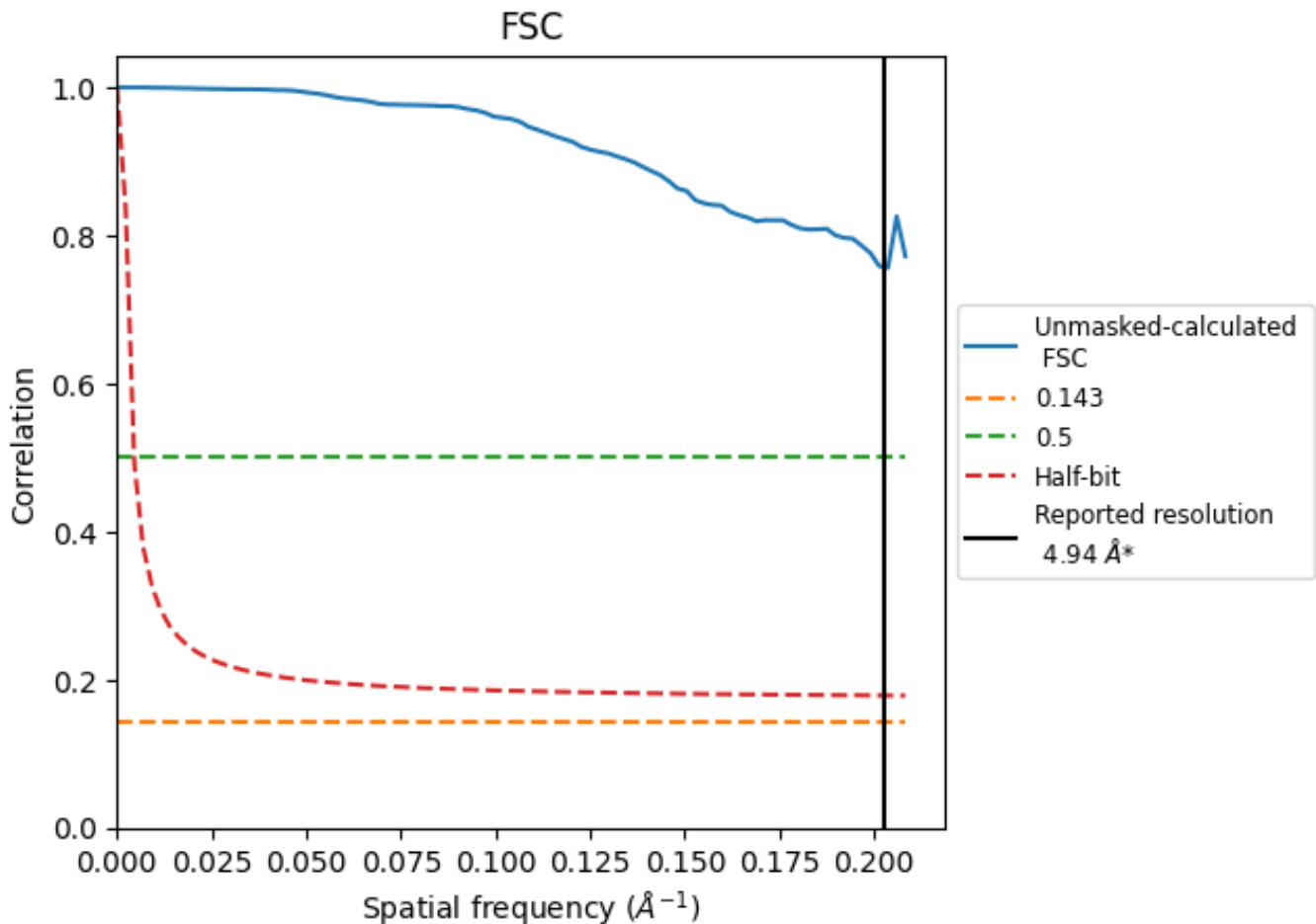

*Reported resolution corresponds to spatial frequency of 0.202 \AA^{-1}

8.2 Resolution estimates [i](#)

Resolution estimate (Å)	Estimation criterion (FSC cut-off)		
	0.143	0.5	Half-bit
Reported by author	4.94	-	-
Author-provided FSC curve	-	-	-
Unmasked-calculated*	-	-	-

*Resolution estimate based on FSC curve calculated by comparison of deposited half-maps.

9 Map-model fit [i](#)

This section contains information regarding the fit between EMDB map EMD-34861 and PDB model 8HKV. Per-residue inclusion information can be found in section 3 on page 11.

9.1 Map-model overlay [i](#)

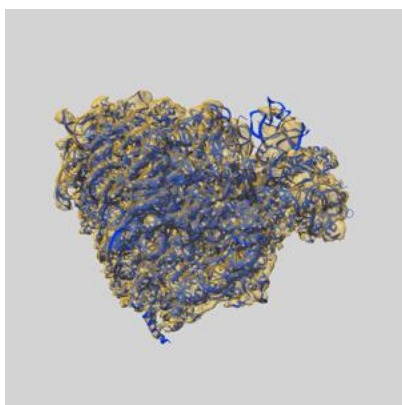

X

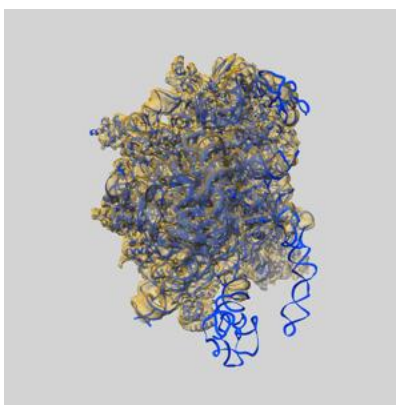

Y

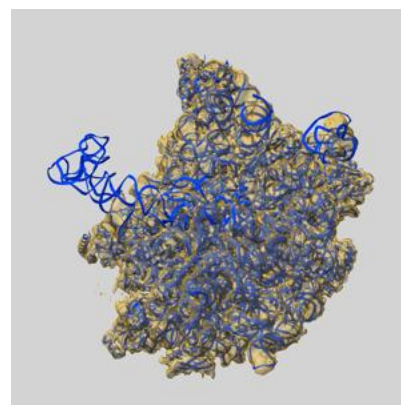

Z

The images above show the 3D surface view of the map at the recommended contour level 0.69 at 50% transparency in yellow overlaid with a ribbon representation of the model coloured in blue. These images allow for the visual assessment of the quality of fit between the atomic model and the map.

9.2 Q-score mapped to coordinate model [i](#)

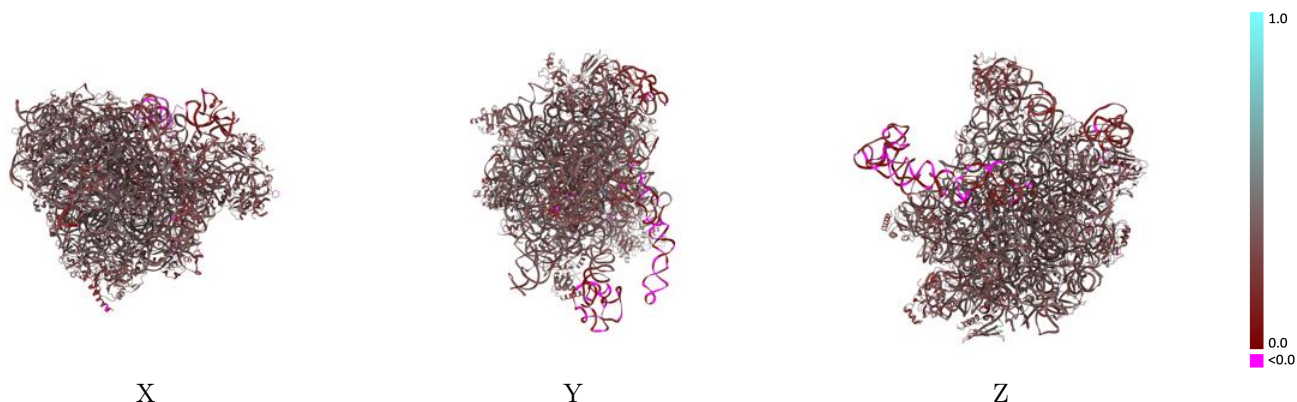

The images above show the model with each residue coloured according to its Q-score. This shows their resolvability in the map with higher Q-score values reflecting better resolvability. Please note: Q-score is calculating the resolvability of atoms, and thus high values are only expected at resolutions at which atoms can be resolved. Low Q-score values may therefore be expected for many entries.

9.3 Atom inclusion mapped to coordinate model [i](#)

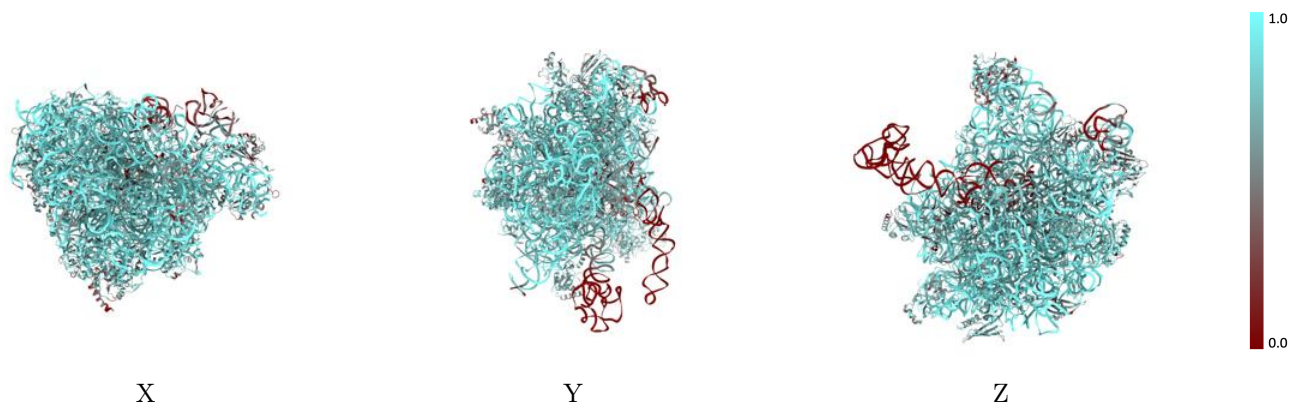

The images above show the model with each residue coloured according to its atom inclusion. This shows to what extent they are inside the map at the recommended contour level (0.69).



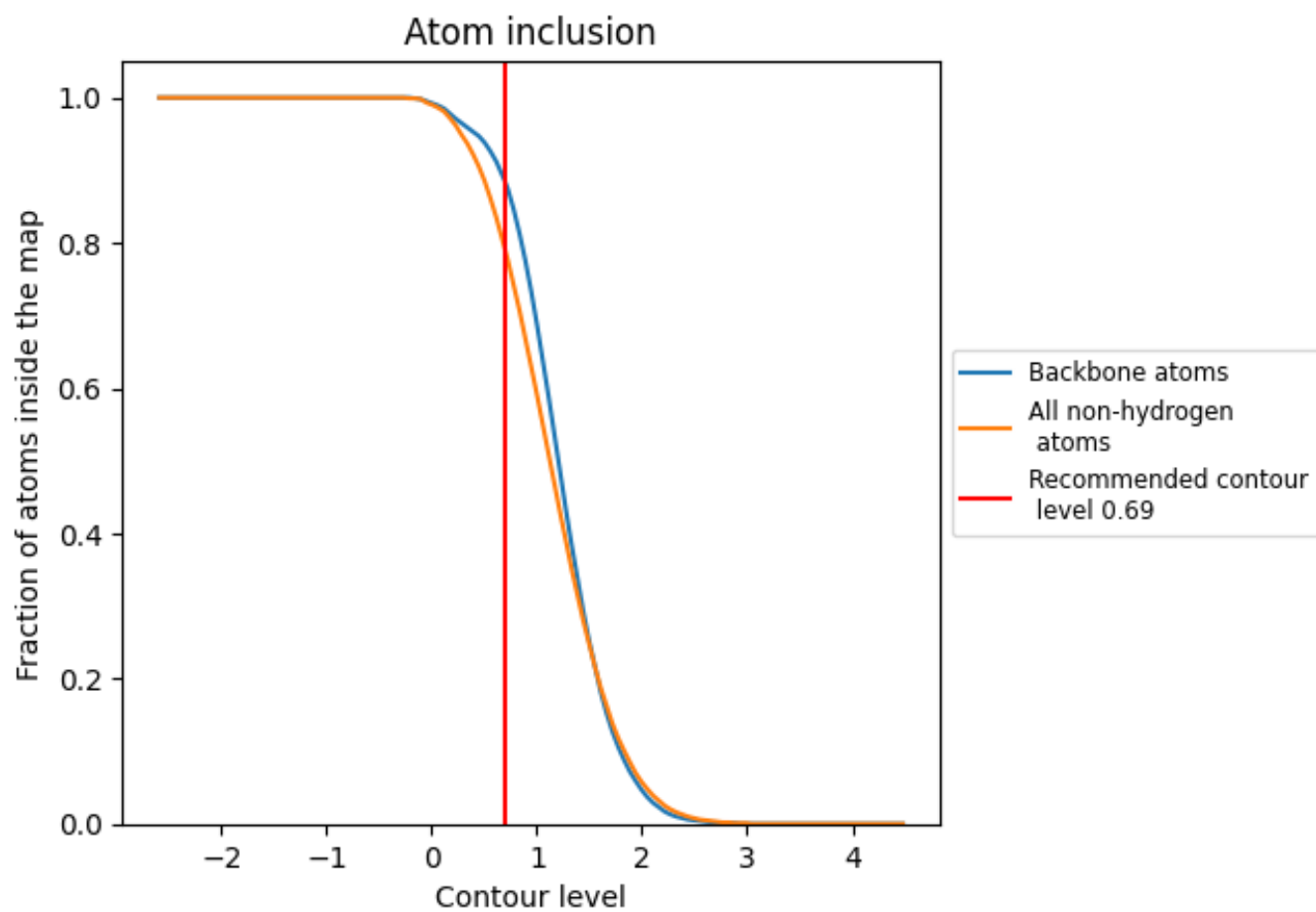



































































9.4 Atom inclusion [i](#)



At the recommended contour level, 89% of all backbone atoms, 80% of all non-hydrogen atoms, are inside the map.

9.5 Map-model fit summary











The table lists the average atom inclusion at the recommended contour level (0.69) and Q-score for the entire model and for each chain.

Chain	Atom inclusion	Q-score
All	 0.7950	 0.3240
A23S	 0.8550	 0.3230
A5S	 0.9440	 0.3270
AL2P	 0.5930	 0.3040
AL3P	 0.7390	 0.3370
AL4P	 0.7680	 0.3660
AL5P	 0.4510	 0.2690
AL6P	 0.6410	 0.3270
ALX0	 0.6370	 0.2910
L10E	 0.6080	 0.3240
L13P	 0.7150	 0.3250
L141	 0.7020	 0.3140
L142	 0.6150	 0.2910
L14P	 0.7560	 0.3410
L15E	 0.6800	 0.3270
L15P	 0.6610	 0.3280
L18E	 0.7540	 0.3570
L18P	 0.6560	 0.2780
L19E	 0.7650	 0.3470
L21E	 0.6980	 0.3510
L22P	 0.7280	 0.3560
L23P	 0.6980	 0.3600
L24E	 0.8440	 0.3630
L24P	 0.6950	 0.3400
L29P	 0.6450	 0.3100
L30E	 0.6990	 0.3060
L30P	 0.6880	 0.2950
L31E	 0.7450	 0.3670
L32E	 0.6570	 0.3640
L34E	 0.6830	 0.2840
L37A	 0.7680	 0.3250
L37E	 0.7720	 0.3440
L39E	 0.7060	 0.3240
L40E	 0.4890	 0.2630
L44E	 0.6560	 0.3200



Continued on next page...

Continued from previous page...

Chain	Atom inclusion	Q-score
L45A	 0.6630	 0.3430
L46A	 0.6560	 0.3500
L47A	 0.5490	 0.3610
L7A1	 0.6780	 0.2980
L7A2	 0.5400	 0.2830