



# Full wwPDB EM Validation Report ⓘ

Apr 3, 2024 – 02:38 am BST

PDB ID : 8R1C  
EMDB ID : EMD-18807  
Title : SD1-2 Fab in complex with SARS-CoV-2 BA.2.12.1 Spike Glycoprotein  
Authors : Duyvesteyn, H.M.E.; Ren, J.; Stuart, D.I.  
Deposited on : 2023-11-01  
Resolution : 2.20 Å (reported)  
Based on initial model : 8CIM

This is a Full wwPDB EM Validation Report for a publicly released PDB entry.

We welcome your comments at [validation@mail.wwpdb.org](mailto:validation@mail.wwpdb.org)

A user guide is available at

<https://www.wwpdb.org/validation/2017/EMValidationReportHelp>

with specific help available everywhere you see the ⓘ symbol.

The types of validation reports are described at

<http://www.wwpdb.org/validation/2017/FAQs#types>.

---

The following versions of software and data (see [references ⓘ](#)) were used in the production of this report:

EMDB validation analysis : 0.0.1.dev92  
Mogul : 1.8.4, CSD as541be (2020)  
MolProbity : 4.02b-467  
Percentile statistics : 20191225.v01 (using entries in the PDB archive December 25th 2019)  
MapQ : 1.9.13  
Ideal geometry (proteins) : Engh & Huber (2001)  
Ideal geometry (DNA, RNA) : Parkinson et al. (1996)  
Validation Pipeline (wwPDB-VP) : 2.36

# 1 Overall quality at a glance i

The following experimental techniques were used to determine the structure:

*ELECTRON MICROSCOPY*

The reported resolution of this entry is 2.20 Å.

Percentile scores (ranging between 0-100) for global validation metrics of the entry are shown in the following graphic. The table shows the number of entries on which the scores are based.

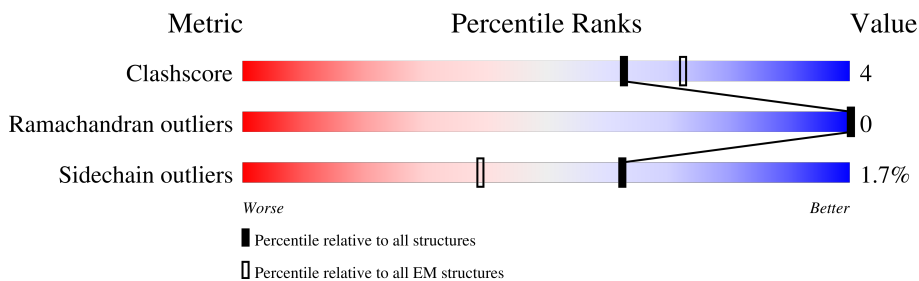

Metric	Whole archive (#Entries)	EM structures (#Entries)
Clashscore	158937	4297
Ramachandran outliers	154571	4023
Sidechain outliers	154315	3826

The table below summarises the geometric issues observed across the polymeric chains and their fit to the map. The red, orange, yellow and green segments of the bar indicate the fraction of residues that contain outliers for  $\geq 3$ , 2, 1 and 0 types of geometric quality criteria respectively. A grey segment represents the fraction of residues that are not modelled. The numeric value for each fraction is indicated below the corresponding segment, with a dot representing fractions  $\leq 5\%$ . The upper red bar (where present) indicates the fraction of residues that have poor fit to the EM map (all-atom inclusion  $< 40\%$ ). The numeric value is given above the bar.

Mol	Chain	Length	Quality of chain
1	A	1285	
1	B	1285	
1	C	1285	
2	D	124	
2	F	124	
2	H	124	
3	E	110	
3	G	110	

Continued on next page...

*Continued from previous page...*

Mol	Chain	Length	Quality of chain
3	L	110	 <p>A horizontal bar chart representing the quality of chain. The bar is divided into three segments: a red segment on the left labeled '31%', a green segment in the middle labeled '84%', and a yellow segment on the right labeled '13%'. There are two small black dots at the end of the bar.</p>

## 2 Entry composition i

There are 4 unique types of molecules in this entry. The entry contains 30426 atoms, of which 0 are hydrogens and 0 are deuteriums.

In the tables below, the AltConf column contains the number of residues with at least one atom in alternate conformation and the Trace column contains the number of residues modelled with at most 2 atoms.

- Molecule 1 is a protein called Spike glycoprotein,Fibritin.

Mol	Chain	Residues	Atoms					AltConf	Trace
			Total	C	N	O	S		
1	A	1056	8276	5300	1373	1565	38	0	0
1	B	1056	8276	5300	1373	1565	38	0	0
1	C	1056	8276	5300	1373	1565	38	0	0

There are 261 discrepancies between the modelled and reference sequences:

Chain	Residue	Modelled	Actual	Comment	Reference
A	19	ILE	THR	variant	UNP P0DTC2
A	?	-	LEU	deletion	UNP P0DTC2
A	?	-	PRO	deletion	UNP P0DTC2
A	?	-	PRO	deletion	UNP P0DTC2
A	24	SER	ALA	variant	UNP P0DTC2
A	139	ASP	GLY	variant	UNP P0DTC2
A	210	GLY	VAL	variant	UNP P0DTC2
A	336	ASP	GLY	variant	UNP P0DTC2
A	368	PHE	SER	variant	UNP P0DTC2
A	370	PRO	SER	variant	UNP P0DTC2
A	372	PHE	SER	variant	UNP P0DTC2
A	373	ALA	THR	variant	UNP P0DTC2
A	402	ASN	ASP	variant	UNP P0DTC2
A	405	SER	ARG	variant	UNP P0DTC2
A	414	ASN	LYS	variant	UNP P0DTC2
A	437	LYS	ASN	variant	UNP P0DTC2
A	449	GLN	LEU	variant	UNP P0DTC2
A	474	ASN	SER	variant	UNP P0DTC2
A	475	LYS	THR	variant	UNP P0DTC2
A	481	ALA	GLU	engineered mutation	UNP P0DTC2
A	490	ARG	GLN	variant	UNP P0DTC2
A	495	ARG	GLN	variant	UNP P0DTC2
A	498	TYR	ASN	variant	UNP P0DTC2
A	502	HIS	TYR	variant	UNP P0DTC2

*Continued on next page...*

*Continued from previous page...*

Chain	Residue	Modelled	Actual	Comment	Reference
A	611	GLY	ASP	variant	UNP P0DTC2
A	652	TYR	HIS	variant	UNP P0DTC2
A	676	LYS	ASN	variant	UNP P0DTC2
A	678	HIS	PRO	variant	UNP P0DTC2
A	701	LEU	SER	variant	UNP P0DTC2
A	761	LYS	ASN	variant	UNP P0DTC2
A	793	TYR	ASP	variant	UNP P0DTC2
A	951	HIS	GLN	variant	UNP P0DTC2
A	966	LYS	ASN	variant	UNP P0DTC2
A	1206	GLY	-	linker	UNP P0DTC2
A	1207	SER	-	linker	UNP P0DTC2
A	1229	LEU	PHE	engineered mutation	UNP P10104
A	1235	GLY	-	expression tag	UNP P10104
A	1236	ARG	-	expression tag	UNP P10104
A	1237	SER	-	expression tag	UNP P10104
A	1238	LEU	-	expression tag	UNP P10104
A	1239	GLU	-	expression tag	UNP P10104
A	1240	VAL	-	expression tag	UNP P10104
A	1241	LEU	-	expression tag	UNP P10104
A	1242	PHE	-	expression tag	UNP P10104
A	1243	GLN	-	expression tag	UNP P10104
A	1244	GLY	-	expression tag	UNP P10104
A	1245	PRO	-	expression tag	UNP P10104
A	1246	GLY	-	expression tag	UNP P10104
A	1247	HIS	-	expression tag	UNP P10104
A	1248	HIS	-	expression tag	UNP P10104
A	1249	HIS	-	expression tag	UNP P10104
A	1250	HIS	-	expression tag	UNP P10104
A	1251	HIS	-	expression tag	UNP P10104
A	1252	HIS	-	expression tag	UNP P10104
A	1253	HIS	-	expression tag	UNP P10104
A	1254	HIS	-	expression tag	UNP P10104
A	1255	GLY	-	expression tag	UNP P10104
A	1256	SER	-	expression tag	UNP P10104
A	1257	ALA	-	expression tag	UNP P10104
A	1258	TRP	-	expression tag	UNP P10104
A	1259	SER	-	expression tag	UNP P10104
A	1260	HIS	-	expression tag	UNP P10104
A	1261	PRO	-	expression tag	UNP P10104
A	1262	GLN	-	expression tag	UNP P10104
A	1263	PHE	-	expression tag	UNP P10104
A	1264	GLU	-	expression tag	UNP P10104

*Continued on next page...*

*Continued from previous page...*

Chain	Residue	Modelled	Actual	Comment	Reference
A	1265	LYS	-	expression tag	UNP P10104
A	1266	GLY	-	expression tag	UNP P10104
A	1267	GLY	-	expression tag	UNP P10104
A	1268	GLY	-	expression tag	UNP P10104
A	1269	SER	-	expression tag	UNP P10104
A	1270	GLY	-	expression tag	UNP P10104
A	1271	GLY	-	expression tag	UNP P10104
A	1272	GLY	-	expression tag	UNP P10104
A	1273	SER	-	expression tag	UNP P10104
A	1274	GLY	-	expression tag	UNP P10104
A	1275	GLY	-	expression tag	UNP P10104
A	1276	SER	-	expression tag	UNP P10104
A	1277	ALA	-	expression tag	UNP P10104
A	1278	TRP	-	expression tag	UNP P10104
A	1279	SER	-	expression tag	UNP P10104
A	1280	HIS	-	expression tag	UNP P10104
A	1281	PRO	-	expression tag	UNP P10104
A	1282	GLN	-	expression tag	UNP P10104
A	1283	PHE	-	expression tag	UNP P10104
A	1284	GLU	-	expression tag	UNP P10104
A	1285	LYS	-	expression tag	UNP P10104
B	19	ILE	THR	variant	UNP P0DTC2
B	?	-	LEU	deletion	UNP P0DTC2
B	?	-	PRO	deletion	UNP P0DTC2
B	?	-	PRO	deletion	UNP P0DTC2
B	24	SER	ALA	variant	UNP P0DTC2
B	139	ASP	GLY	variant	UNP P0DTC2
B	210	GLY	VAL	variant	UNP P0DTC2
B	336	ASP	GLY	variant	UNP P0DTC2
B	368	PHE	SER	variant	UNP P0DTC2
B	370	PRO	SER	variant	UNP P0DTC2
B	372	PHE	SER	variant	UNP P0DTC2
B	373	ALA	THR	variant	UNP P0DTC2
B	402	ASN	ASP	variant	UNP P0DTC2
B	405	SER	ARG	variant	UNP P0DTC2
B	414	ASN	LYS	variant	UNP P0DTC2
B	437	LYS	ASN	variant	UNP P0DTC2
B	449	GLN	LEU	variant	UNP P0DTC2
B	474	ASN	SER	variant	UNP P0DTC2
B	475	LYS	THR	variant	UNP P0DTC2
B	481	ALA	GLU	engineered mutation	UNP P0DTC2
B	490	ARG	GLN	variant	UNP P0DTC2

*Continued on next page...*

*Continued from previous page...*

Chain	Residue	Modelled	Actual	Comment	Reference
B	495	ARG	GLN	variant	UNP P0DTC2
B	498	TYR	ASN	variant	UNP P0DTC2
B	502	HIS	TYR	variant	UNP P0DTC2
B	611	GLY	ASP	variant	UNP P0DTC2
B	652	TYR	HIS	variant	UNP P0DTC2
B	676	LYS	ASN	variant	UNP P0DTC2
B	678	HIS	PRO	variant	UNP P0DTC2
B	701	LEU	SER	variant	UNP P0DTC2
B	761	LYS	ASN	variant	UNP P0DTC2
B	793	TYR	ASP	variant	UNP P0DTC2
B	951	HIS	GLN	variant	UNP P0DTC2
B	966	LYS	ASN	variant	UNP P0DTC2
B	1206	GLY	-	linker	UNP P0DTC2
B	1207	SER	-	linker	UNP P0DTC2
B	1229	LEU	PHE	engineered mutation	UNP P10104
B	1235	GLY	-	expression tag	UNP P10104
B	1236	ARG	-	expression tag	UNP P10104
B	1237	SER	-	expression tag	UNP P10104
B	1238	LEU	-	expression tag	UNP P10104
B	1239	GLU	-	expression tag	UNP P10104
B	1240	VAL	-	expression tag	UNP P10104
B	1241	LEU	-	expression tag	UNP P10104
B	1242	PHE	-	expression tag	UNP P10104
B	1243	GLN	-	expression tag	UNP P10104
B	1244	GLY	-	expression tag	UNP P10104
B	1245	PRO	-	expression tag	UNP P10104
B	1246	GLY	-	expression tag	UNP P10104
B	1247	HIS	-	expression tag	UNP P10104
B	1248	HIS	-	expression tag	UNP P10104
B	1249	HIS	-	expression tag	UNP P10104
B	1250	HIS	-	expression tag	UNP P10104
B	1251	HIS	-	expression tag	UNP P10104
B	1252	HIS	-	expression tag	UNP P10104
B	1253	HIS	-	expression tag	UNP P10104
B	1254	HIS	-	expression tag	UNP P10104
B	1255	GLY	-	expression tag	UNP P10104
B	1256	SER	-	expression tag	UNP P10104
B	1257	ALA	-	expression tag	UNP P10104
B	1258	TRP	-	expression tag	UNP P10104
B	1259	SER	-	expression tag	UNP P10104
B	1260	HIS	-	expression tag	UNP P10104
B	1261	PRO	-	expression tag	UNP P10104

*Continued on next page...*

*Continued from previous page...*

Chain	Residue	Modelled	Actual	Comment	Reference
B	1262	GLN	-	expression tag	UNP P10104
B	1263	PHE	-	expression tag	UNP P10104
B	1264	GLU	-	expression tag	UNP P10104
B	1265	LYS	-	expression tag	UNP P10104
B	1266	GLY	-	expression tag	UNP P10104
B	1267	GLY	-	expression tag	UNP P10104
B	1268	GLY	-	expression tag	UNP P10104
B	1269	SER	-	expression tag	UNP P10104
B	1270	GLY	-	expression tag	UNP P10104
B	1271	GLY	-	expression tag	UNP P10104
B	1272	GLY	-	expression tag	UNP P10104
B	1273	SER	-	expression tag	UNP P10104
B	1274	GLY	-	expression tag	UNP P10104
B	1275	GLY	-	expression tag	UNP P10104
B	1276	SER	-	expression tag	UNP P10104
B	1277	ALA	-	expression tag	UNP P10104
B	1278	TRP	-	expression tag	UNP P10104
B	1279	SER	-	expression tag	UNP P10104
B	1280	HIS	-	expression tag	UNP P10104
B	1281	PRO	-	expression tag	UNP P10104
B	1282	GLN	-	expression tag	UNP P10104
B	1283	PHE	-	expression tag	UNP P10104
B	1284	GLU	-	expression tag	UNP P10104
B	1285	LYS	-	expression tag	UNP P10104
C	19	ILE	THR	variant	UNP P0DTC2
C	?	-	LEU	deletion	UNP P0DTC2
C	?	-	PRO	deletion	UNP P0DTC2
C	?	-	PRO	deletion	UNP P0DTC2
C	24	SER	ALA	variant	UNP P0DTC2
C	139	ASP	GLY	variant	UNP P0DTC2
C	210	GLY	VAL	variant	UNP P0DTC2
C	336	ASP	GLY	variant	UNP P0DTC2
C	368	PHE	SER	variant	UNP P0DTC2
C	370	PRO	SER	variant	UNP P0DTC2
C	372	PHE	SER	variant	UNP P0DTC2
C	373	ALA	THR	variant	UNP P0DTC2
C	402	ASN	ASP	variant	UNP P0DTC2
C	405	SER	ARG	variant	UNP P0DTC2
C	414	ASN	LYS	variant	UNP P0DTC2
C	437	LYS	ASN	variant	UNP P0DTC2
C	449	GLN	LEU	variant	UNP P0DTC2
C	474	ASN	SER	variant	UNP P0DTC2

*Continued on next page...*



*Continued from previous page...*

Chain	Residue	Modelled	Actual	Comment	Reference
C	475	LYS	THR	variant	UNP P0DTC2
C	481	ALA	GLU	engineered mutation	UNP P0DTC2
C	490	ARG	GLN	variant	UNP P0DTC2
C	495	ARG	GLN	variant	UNP P0DTC2
C	498	TYR	ASN	variant	UNP P0DTC2
C	502	HIS	TYR	variant	UNP P0DTC2
C	611	GLY	ASP	variant	UNP P0DTC2
C	652	TYR	HIS	variant	UNP P0DTC2
C	676	LYS	ASN	variant	UNP P0DTC2
C	678	HIS	PRO	variant	UNP P0DTC2
C	701	LEU	SER	variant	UNP P0DTC2
C	761	LYS	ASN	variant	UNP P0DTC2
C	793	TYR	ASP	variant	UNP P0DTC2
C	951	HIS	GLN	variant	UNP P0DTC2
C	966	LYS	ASN	variant	UNP P0DTC2
C	1206	GLY	-	linker	UNP P0DTC2
C	1207	SER	-	linker	UNP P0DTC2
C	1229	LEU	PHE	engineered mutation	UNP P10104
C	1235	GLY	-	expression tag	UNP P10104
C	1236	ARG	-	expression tag	UNP P10104
C	1237	SER	-	expression tag	UNP P10104
C	1238	LEU	-	expression tag	UNP P10104
C	1239	GLU	-	expression tag	UNP P10104
C	1240	VAL	-	expression tag	UNP P10104
C	1241	LEU	-	expression tag	UNP P10104
C	1242	PHE	-	expression tag	UNP P10104
C	1243	GLN	-	expression tag	UNP P10104
C	1244	GLY	-	expression tag	UNP P10104
C	1245	PRO	-	expression tag	UNP P10104
C	1246	GLY	-	expression tag	UNP P10104
C	1247	HIS	-	expression tag	UNP P10104
C	1248	HIS	-	expression tag	UNP P10104
C	1249	HIS	-	expression tag	UNP P10104
C	1250	HIS	-	expression tag	UNP P10104
C	1251	HIS	-	expression tag	UNP P10104
C	1252	HIS	-	expression tag	UNP P10104
C	1253	HIS	-	expression tag	UNP P10104
C	1254	HIS	-	expression tag	UNP P10104
C	1255	GLY	-	expression tag	UNP P10104
C	1256	SER	-	expression tag	UNP P10104
C	1257	ALA	-	expression tag	UNP P10104
C	1258	TRP	-	expression tag	UNP P10104

*Continued on next page...*

*Continued from previous page...*

Chain	Residue	Modelled	Actual	Comment	Reference
C	1259	SER	-	expression tag	UNP P10104
C	1260	HIS	-	expression tag	UNP P10104
C	1261	PRO	-	expression tag	UNP P10104
C	1262	GLN	-	expression tag	UNP P10104
C	1263	PHE	-	expression tag	UNP P10104
C	1264	GLU	-	expression tag	UNP P10104
C	1265	LYS	-	expression tag	UNP P10104
C	1266	GLY	-	expression tag	UNP P10104
C	1267	GLY	-	expression tag	UNP P10104
C	1268	GLY	-	expression tag	UNP P10104
C	1269	SER	-	expression tag	UNP P10104
C	1270	GLY	-	expression tag	UNP P10104
C	1271	GLY	-	expression tag	UNP P10104
C	1272	GLY	-	expression tag	UNP P10104
C	1273	SER	-	expression tag	UNP P10104
C	1274	GLY	-	expression tag	UNP P10104
C	1275	GLY	-	expression tag	UNP P10104
C	1276	SER	-	expression tag	UNP P10104
C	1277	ALA	-	expression tag	UNP P10104
C	1278	TRP	-	expression tag	UNP P10104
C	1279	SER	-	expression tag	UNP P10104
C	1280	HIS	-	expression tag	UNP P10104
C	1281	PRO	-	expression tag	UNP P10104
C	1282	GLN	-	expression tag	UNP P10104
C	1283	PHE	-	expression tag	UNP P10104
C	1284	GLU	-	expression tag	UNP P10104
C	1285	LYS	-	expression tag	UNP P10104

- Molecule 2 is a protein called SD1-2 fab heavy chain.

Mol	Chain	Residues	Atoms					AltConf	Trace
2	H	124	Total	C	N	O	S	0	0
			931	583	158	185	5		
2	D	124	Total	C	N	O	S	0	0
			931	583	158	185	5		
2	F	124	Total	C	N	O	S	0	0
			931	583	158	185	5		

- Molecule 3 is a protein called SD1-2 fab light chain.

Mol	Chain	Residues	Atoms					AltConf	Trace
			Total	C	N	O	S		
3	L	109	Total 795	C 496	N 129	O 166	S 4	0	0
3	E	109	Total 795	C 496	N 129	O 166	S 4	0	0
3	G	109	Total 795	C 496	N 129	O 166	S 4	0	0

- Molecule 4 is 2-acetamido-2-deoxy-beta-D-glucopyranose (three-letter code: NAG) (formula:  $C_8H_{15}NO_6$ ).

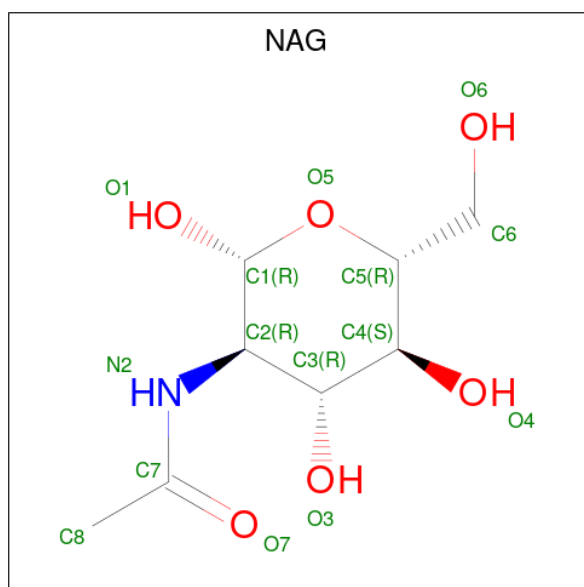

Mol	Chain	Residues	Atoms				AltConf
			Total	C	N	O	
4	A	1	Total 14	C 8	N 1	O 5	0
4	A	1	Total 14	C 8	N 1	O 5	0
4	A	1	Total 14	C 8	N 1	O 5	0
4	A	1	Total 14	C 8	N 1	O 5	0
4	A	1	Total 14	C 8	N 1	O 5	0
4	A	1	Total 14	C 8	N 1	O 5	0
4	A	1	Total 14	C 8	N 1	O 5	0
4	A	1	Total 14	C 8	N 1	O 5	0

*Continued on next page...*

*Continued from previous page...*

Mol	Chain	Residues	Atoms				AltConf
			Total	C	N	O	
4	A	1	Total 14	C 8	N 1	O 5	0
4	A	1	Total 14	C 8	N 1	O 5	0
4	B	1	Total 14	C 8	N 1	O 5	0
4	B	1	Total 14	C 8	N 1	O 5	0
4	B	1	Total 14	C 8	N 1	O 5	0
4	B	1	Total 14	C 8	N 1	O 5	0
4	B	1	Total 14	C 8	N 1	O 5	0
4	B	1	Total 14	C 8	N 1	O 5	0
4	B	1	Total 14	C 8	N 1	O 5	0
4	B	1	Total 14	C 8	N 1	O 5	0
4	B	1	Total 14	C 8	N 1	O 5	0
4	B	1	Total 14	C 8	N 1	O 5	0
4	B	1	Total 14	C 8	N 1	O 5	0
4	B	1	Total 14	C 8	N 1	O 5	0
4	C	1	Total 14	C 8	N 1	O 5	0
4	C	1	Total 14	C 8	N 1	O 5	0
4	C	1	Total 14	C 8	N 1	O 5	0
4	C	1	Total 14	C 8	N 1	O 5	0
4	C	1	Total 14	C 8	N 1	O 5	0
4	C	1	Total 14	C 8	N 1	O 5	0
4	C	1	Total 14	C 8	N 1	O 5	0
4	C	1	Total 14	C 8	N 1	O 5	0
4	C	1	Total 14	C 8	N 1	O 5	0

*Continued on next page...*

*Continued from previous page...*

Mol	Chain	Residues	Atoms				AltConf
			Total	C	N	O	
4	C	1	14	8	1	5	0

### 3 Residue-property plots

These plots are drawn for all protein, RNA, DNA and oligosaccharide chains in the entry. The first graphic for a chain summarises the proportions of the various outlier classes displayed in the second graphic. The second graphic shows the sequence view annotated by issues in geometry and atom inclusion in map density. Residues are color-coded according to the number of geometric quality criteria for which they contain at least one outlier: green = 0, yellow = 1, orange = 2 and red = 3 or more. A red diamond above a residue indicates a poor fit to the EM map for this residue (all-atom inclusion < 40%). Stretches of 2 or more consecutive residues without any outlier are shown as a green connector. Residues present in the sample, but not in the model, are shown in grey.

- Molecule 1: Spike glycoprotein,Fibrin

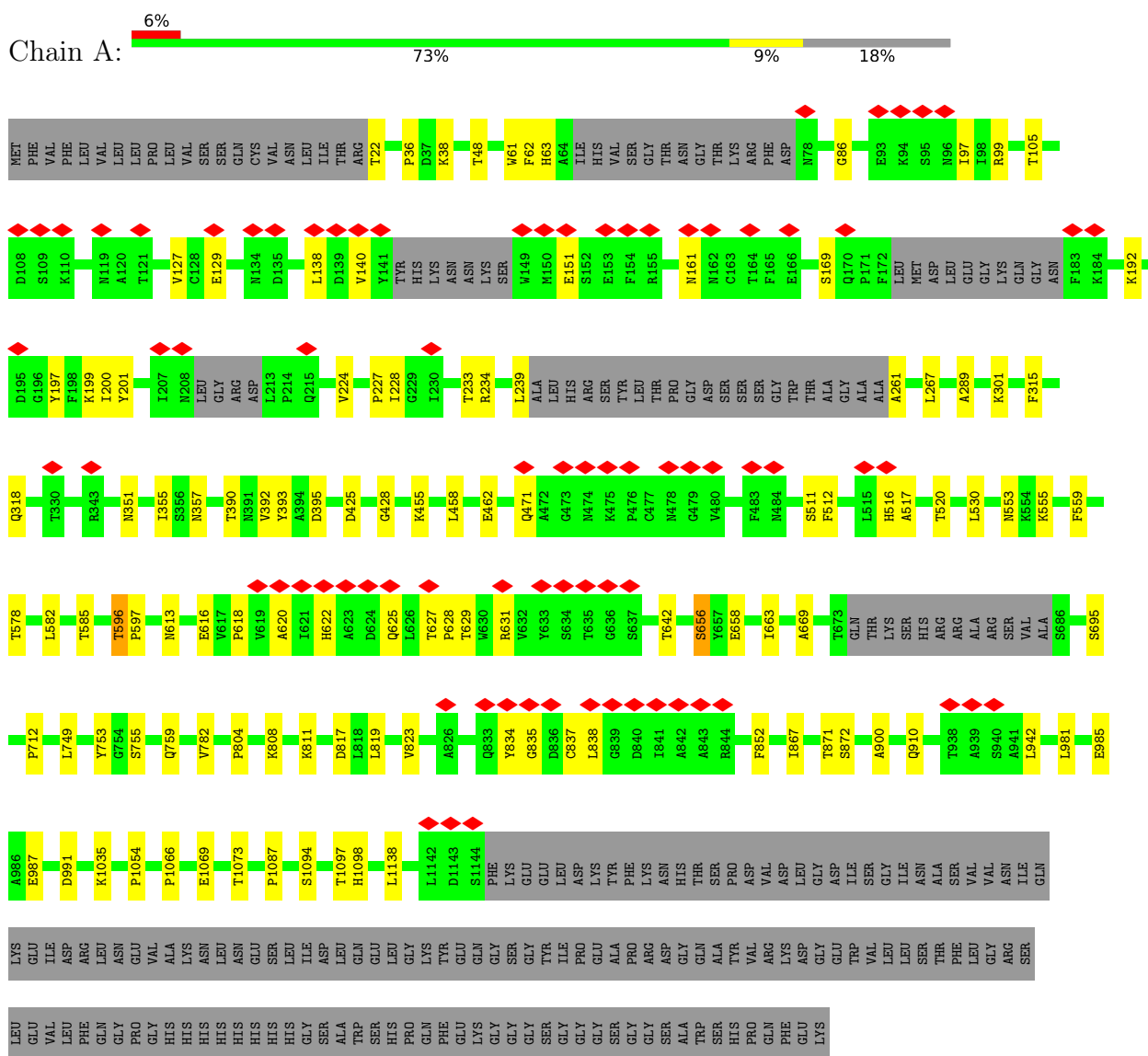

- Molecule 1: Spike glycoprotein,Fibrin

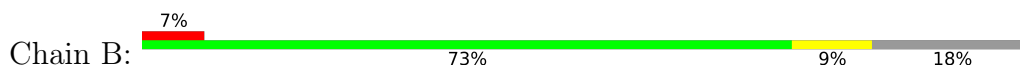

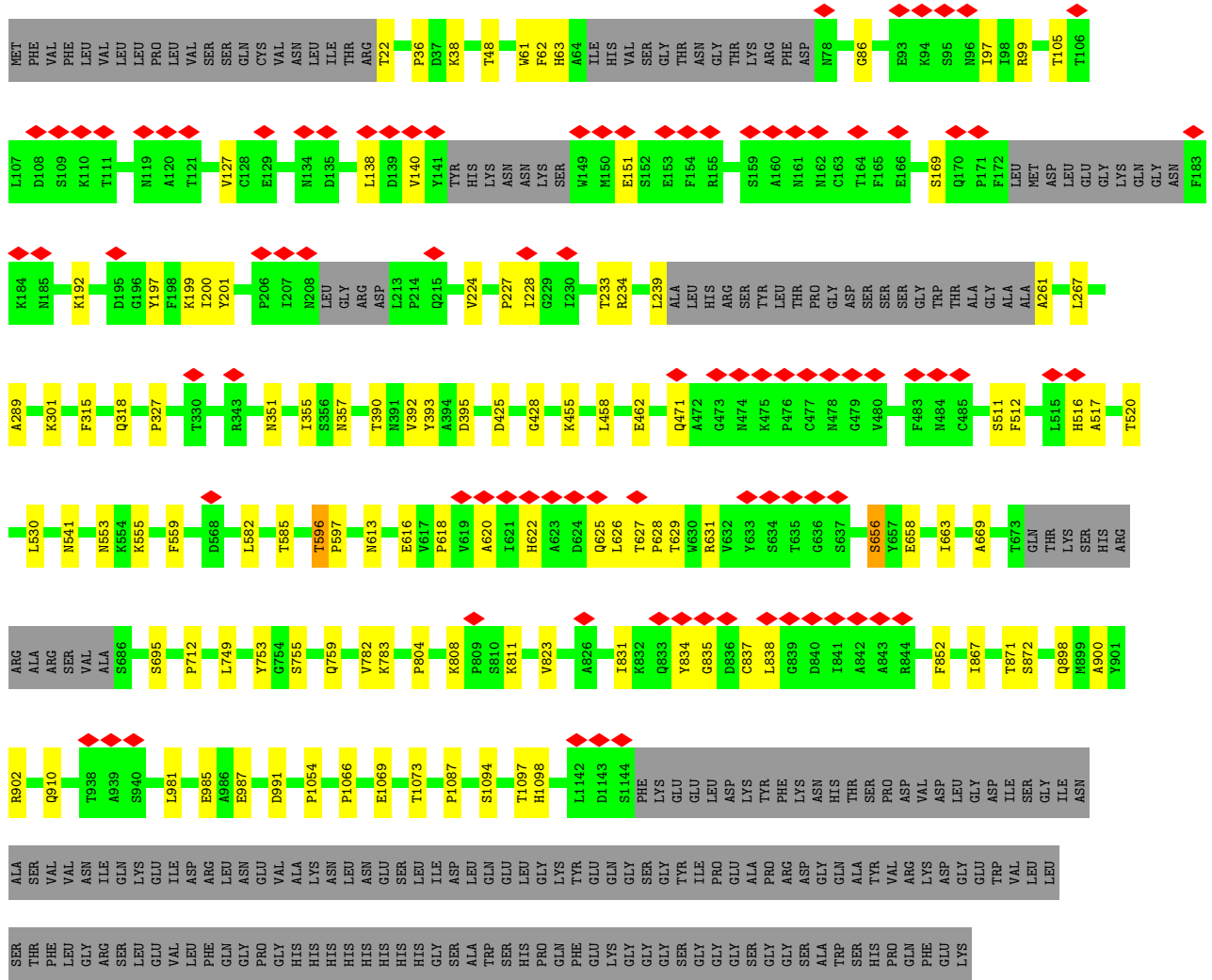

● Molecule 1: Spike glycoprotein, Fibrin

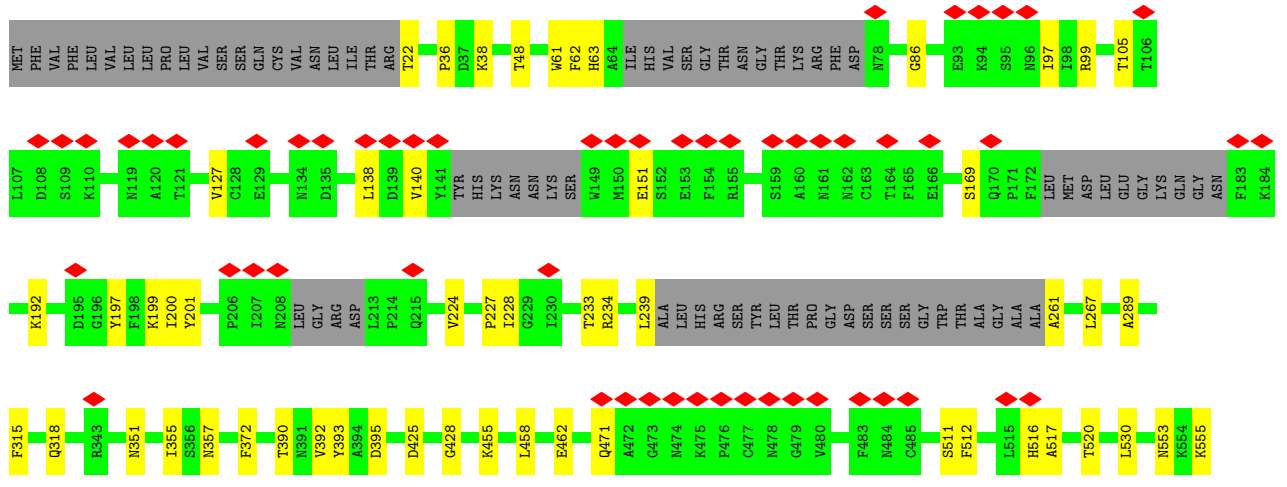





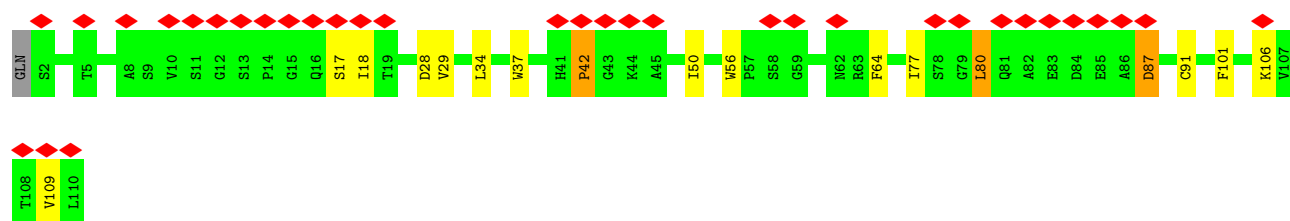
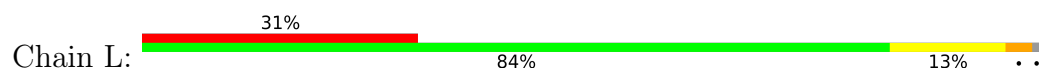

- Molecule 3: SD1-2 fab light chain

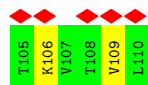
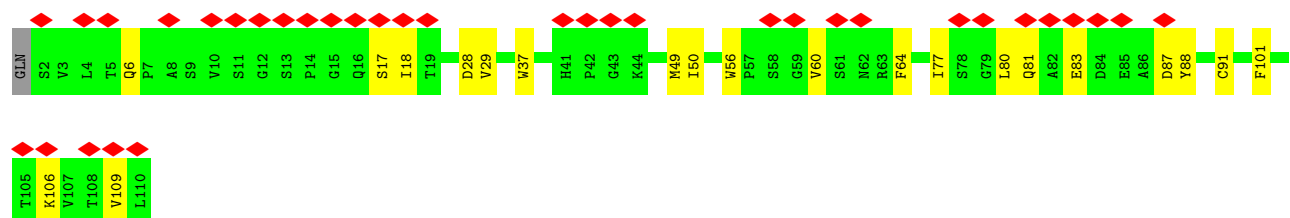
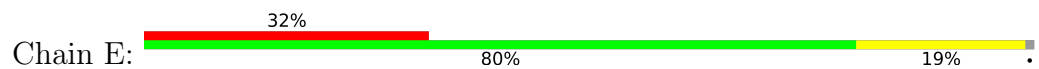

- Molecule 3: SD1-2 fab light chain

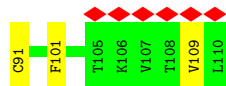
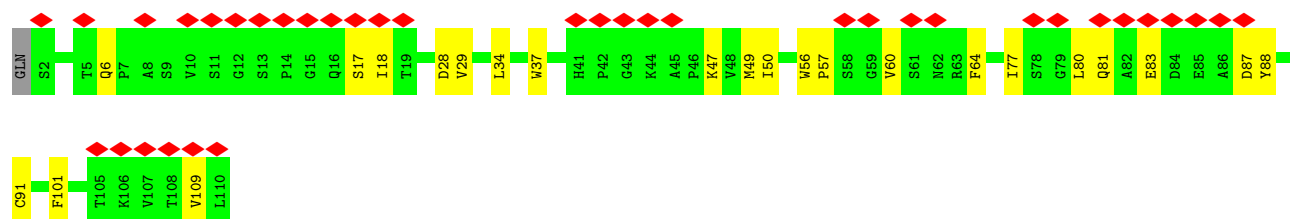
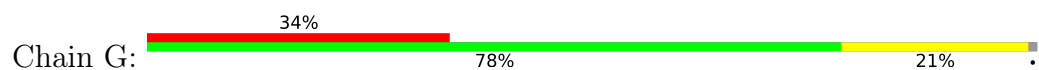

## 4 Experimental information

Property	Value	Source
EM reconstruction method	SINGLE PARTICLE	Depositor
Imposed symmetry	POINT, C3	Depositor
Number of particles used	503734	Depositor
Resolution determination method	FSC 0.143 CUT-OFF	Depositor
CTF correction method	PHASE FLIPPING AND AMPLITUDE CORRECTION; Patch CTF and Motion correction, on-the-fly.	Depositor
Microscope	FEI TITAN KRIOS	Depositor
Voltage (kV)	300	Depositor
Electron dose ( $e^-/\text{\AA}^2$ )	50	Depositor
Minimum defocus (nm)	800	Depositor
Maximum defocus (nm)	2600	Depositor
Magnification	165000	Depositor
Image detector	FEI FALCON IV (4k x 4k)	Depositor
Maximum map value	1.872	Depositor
Minimum map value	-1.186	Depositor
Average map value	0.007	Depositor
Map value standard deviation	0.081	Depositor
Recommended contour level	0.148	Depositor
Map size (Å)	163.5872, 164.3175, 184.0356	wwPDB
Map dimensions	224, 225, 252	wwPDB
Map angles (°)	90.0, 90.0, 90.0	wwPDB
Pixel spacing (Å)	0.7303, 0.7303, 0.7303	Depositor

## 5 Model quality [i](#)

### 5.1 Standard geometry [i](#)

Bond lengths and bond angles in the following residue types are not validated in this section: NAG

The Z score for a bond length (or angle) is the number of standard deviations the observed value is removed from the expected value. A bond length (or angle) with  $|Z| > 5$  is considered an outlier worth inspection. RMSZ is the root-mean-square of all Z scores of the bond lengths (or angles).

Mol	Chain	Bond lengths		Bond angles	
		RMSZ	# Z  >5	RMSZ	# Z  >5
1	A	0.29	0/8470	0.48	0/11524
1	B	0.29	0/8470	0.48	0/11524
1	C	0.29	0/8470	0.48	0/11524
2	D	0.69	1/952 (0.1%)	1.29	4/1298 (0.3%)
2	F	0.88	3/952 (0.3%)	1.15	5/1298 (0.4%)
2	H	0.48	3/952 (0.3%)	1.14	5/1298 (0.4%)
3	E	0.27	0/813	0.47	0/1107
3	G	0.26	0/813	0.46	0/1107
3	L	0.29	0/813	0.54	2/1107 (0.2%)
All	All	0.35	7/30705 (0.0%)	0.59	16/41787 (0.0%)

All (7) bond length outliers are listed below:

Mol	Chain	Res	Type	Atoms	Z	Observed(Å)	Ideal(Å)
2	F	9	PRO	CG-CD	-22.50	0.76	1.50
2	D	9	PRO	CG-CD	-18.42	0.89	1.50
2	F	9	PRO	CB-CG	10.12	2.00	1.50
2	H	9	PRO	CB-CG	-7.81	1.10	1.50
2	H	9	PRO	CG-CD	-5.83	1.31	1.50
2	H	9	PRO	N-CA	5.67	1.56	1.47
2	F	9	PRO	N-CD	5.11	1.54	1.47

All (16) bond angle outliers are listed below:

Mol	Chain	Res	Type	Atoms	Z	Observed(°)	Ideal(°)
2	D	9	PRO	N-CD-CG	-34.66	51.20	103.20
2	F	9	PRO	N-CD-CG	-27.03	62.66	103.20
2	H	9	PRO	N-CD-CG	-23.89	67.36	103.20
2	D	9	PRO	CA-CB-CG	-22.57	61.12	104.00
2	F	9	PRO	CA-CB-CG	-19.57	66.81	104.00

*Continued on next page...*

Continued from previous page...

Mol	Chain	Res	Type	Atoms	Z	Observed(°)	Ideal(°)
2	H	9	PRO	CB-CG-CD	18.84	179.97	106.50
2	H	9	PRO	CA-CB-CG	-18.83	68.23	104.00
2	F	9	PRO	N-CA-CB	-10.67	90.50	103.30
2	F	9	PRO	CA-N-CD	-9.67	97.97	111.50
2	D	9	PRO	N-CA-CB	-8.18	93.48	103.30
2	F	9	PRO	CB-CG-CD	-8.11	74.87	106.50
3	L	42	PRO	CA-N-CD	-7.52	100.97	111.50
2	H	9	PRO	CA-N-CD	-6.49	102.41	111.50
3	L	42	PRO	N-CD-CG	-5.76	94.56	103.20
2	H	9	PRO	N-CA-CB	-5.45	96.60	102.60
2	D	9	PRO	CA-N-CD	-5.35	104.01	111.50

There are no chirality outliers.

There are no planarity outliers.

## 5.2 Too-close contacts

In the following table, the Non-H and H(model) columns list the number of non-hydrogen atoms and hydrogen atoms in the chain respectively. The H(added) column lists the number of hydrogen atoms added and optimized by MolProbity. The Clashes column lists the number of clashes within the asymmetric unit, whereas Symm-Clashes lists symmetry-related clashes.

Mol	Chain	Non-H	H(model)	H(added)	Clashes	Symm-Clashes
1	A	8276	0	8073	69	0
1	B	8276	0	8073	68	0
1	C	8276	0	8073	69	0
2	D	931	0	904	14	0
2	F	931	0	904	12	0
2	H	931	0	904	14	0
3	E	795	0	758	10	0
3	G	795	0	758	13	0
3	L	795	0	758	10	0
4	A	140	0	130	1	0
4	B	140	0	130	1	0
4	C	140	0	130	1	0
All	All	30426	0	29595	263	0

The all-atom clashscore is defined as the number of clashes found per 1000 atoms (including hydrogen atoms). The all-atom clashscore for this structure is 4.

All (263) close contacts within the same asymmetric unit are listed below, sorted by their clash magnitude.

Atom-1	Atom-2	Interatomic distance (Å)	Clash overlap (Å)
3:E:17:SER:HA	3:E:77:ILE:O	1.81	0.81
3:G:17:SER:HA	3:G:77:ILE:O	1.81	0.80
3:L:17:SER:HA	3:L:77:ILE:O	1.82	0.80
2:H:40:ARG:HB3	2:H:50:ILE:HD11	1.72	0.71
3:E:80:LEU:HD21	3:E:109:VAL:HG22	1.73	0.71
3:L:80:LEU:HD21	3:L:109:VAL:HG22	1.73	0.70
1:B:596:THR:OG1	1:B:597:PRO:O	2.09	0.70
3:G:80:LEU:HD21	3:G:109:VAL:HG22	1.73	0.70
3:L:56:TRP:NE1	3:L:64:PHE:O	2.24	0.69
1:C:596:THR:OG1	1:C:597:PRO:O	2.09	0.69
1:A:596:THR:OG1	1:A:597:PRO:O	2.09	0.69
1:C:390:THR:O	1:C:520:THR:OG1	2.11	0.68
1:B:390:THR:O	1:B:520:THR:OG1	2.11	0.68
2:D:92:THR:HA	2:D:120:VAL:O	1.94	0.68
3:E:56:TRP:NE1	3:E:64:PHE:O	2.23	0.68
1:A:390:THR:O	1:A:520:THR:OG1	2.11	0.67
1:A:559:PHE:HD2	1:B:38:LYS:HD2	1.59	0.67
2:F:92:THR:HA	2:F:120:VAL:O	1.93	0.67
1:A:38:LYS:HD2	1:C:559:PHE:HD2	1.60	0.66
1:B:559:PHE:HD2	1:C:38:LYS:HD2	1.59	0.66
1:A:835:GLY:H	1:A:838:LEU:HG	1.60	0.66
2:D:40:ARG:HB3	2:D:50:ILE:HD11	1.77	0.65
1:B:835:GLY:H	1:B:838:LEU:HG	1.60	0.65
1:C:663:ILE:HD11	1:C:669:ALA:HB2	1.78	0.65
1:A:663:ILE:HD11	1:A:669:ALA:HB2	1.78	0.65
1:C:981:LEU:HD13	1:C:985:GLU:HG3	1.79	0.65
1:C:835:GLY:H	1:C:838:LEU:HG	1.60	0.65
1:A:981:LEU:HD13	1:A:985:GLU:HG3	1.79	0.64
1:B:663:ILE:HD11	1:B:669:ALA:HB2	1.79	0.64
1:A:808:LYS:NZ	1:A:817:ASP:OD2	2.26	0.64
2:H:92:THR:HA	2:H:120:VAL:O	1.98	0.64
2:D:42:PRO:HG2	2:D:45:GLN:HB2	1.80	0.64
1:B:834:TYR:HB2	1:B:838:LEU:HD11	1.80	0.63
1:C:834:TYR:HB2	1:C:838:LEU:HD11	1.80	0.63
1:A:834:TYR:HB2	1:A:838:LEU:HD11	1.80	0.63
1:B:981:LEU:HD13	1:B:985:GLU:HG3	1.79	0.63
2:H:42:PRO:HG2	2:H:45:GLN:HB2	1.79	0.62
2:F:42:PRO:HG2	2:F:45:GLN:HB2	1.79	0.62
3:G:56:TRP:NE1	3:G:64:PHE:O	2.25	0.62
1:C:22:THR:HB	1:C:63:HIS:HB2	1.82	0.62
1:A:22:THR:HB	1:A:63:HIS:HB2	1.82	0.62
1:C:127:VAL:HG21	1:C:228:ILE:HG21	1.82	0.61

*Continued on next page...*

*Continued from previous page...*

Atom-1	Atom-2	Interatomic distance (Å)	Clash overlap (Å)
2:F:40:ARG:HB3	2:F:50:ILE:HD11	1.82	0.61
1:C:355:ILE:HB	1:C:392:VAL:HB	1.82	0.61
1:B:355:ILE:HB	1:B:392:VAL:HB	1.83	0.61
1:B:22:THR:HB	1:B:63:HIS:HB2	1.82	0.60
1:B:105:THR:HG22	1:B:233:THR:HG22	1.84	0.60
1:C:105:THR:HG22	1:C:233:THR:HG22	1.84	0.60
2:D:53:VAL:HG23	2:D:59:THR:HG22	1.83	0.60
1:B:127:VAL:HG21	1:B:228:ILE:HG21	1.82	0.60
1:B:900:ALA:HB1	1:B:910:GLN:HB2	1.84	0.59
1:A:127:VAL:HG21	1:A:228:ILE:HG21	1.82	0.59
1:B:620:ALA:HB1	1:B:625:GLN:HG3	1.85	0.59
1:A:357:ASN:H	1:A:520:THR:HB	1.68	0.59
1:A:900:ALA:HB1	1:A:910:GLN:HB2	1.84	0.59
1:A:355:ILE:HB	1:A:392:VAL:HB	1.83	0.59
1:C:900:ALA:HB1	1:C:910:GLN:HB2	1.84	0.59
1:B:357:ASN:H	1:B:520:THR:HB	1.68	0.59
1:B:749:LEU:HD11	1:B:987:GLU:HG2	1.85	0.58
1:C:628:PRO:O	1:C:631:ARG:NH1	2.36	0.58
1:C:755:SER:O	1:C:759:GLN:HG3	2.03	0.58
1:A:105:THR:HG22	1:A:233:THR:HG22	1.84	0.58
1:C:357:ASN:H	1:C:520:THR:HB	1.68	0.58
1:A:620:ALA:HB1	1:A:625:GLN:HG3	1.85	0.58
1:C:749:LEU:HD11	1:C:987:GLU:HG2	1.85	0.58
1:A:755:SER:O	1:A:759:GLN:HG3	2.03	0.57
1:C:620:ALA:HB1	1:C:625:GLN:HG3	1.85	0.57
1:B:755:SER:O	1:B:759:GLN:HG3	2.03	0.57
1:A:749:LEU:HD11	1:A:987:GLU:HG2	1.85	0.57
1:A:628:PRO:O	1:A:631:ARG:NH1	2.36	0.57
2:F:53:VAL:HG23	2:F:59:THR:HG22	1.86	0.57
1:C:1097:THR:OG1	1:C:1098:HIS:ND1	2.36	0.57
1:C:200:ILE:HB	1:C:224:VAL:HG12	1.87	0.56
1:C:97:ILE:HG12	1:C:239:LEU:HD22	1.88	0.56
1:A:97:ILE:HG12	1:A:239:LEU:HD22	1.88	0.56
1:A:200:ILE:HB	1:A:224:VAL:HG12	1.87	0.56
1:B:97:ILE:HG12	1:B:239:LEU:HD22	1.88	0.56
1:B:200:ILE:HB	1:B:224:VAL:HG12	1.87	0.56
1:B:140:VAL:HG22	1:B:151:GLU:HG3	1.89	0.55
3:G:49:MET:CE	3:G:60:VAL:HG13	2.36	0.55
1:A:140:VAL:HG22	1:A:151:GLU:HG3	1.89	0.55
2:H:98:VAL:HG21	2:H:111:PHE:HB3	1.89	0.55
1:C:140:VAL:HG22	1:C:151:GLU:HG3	1.89	0.55

*Continued on next page...*

*Continued from previous page...*

Atom-1	Atom-2	Interatomic distance (Å)	Clash overlap (Å)
1:B:622:HIS:HB2	1:B:625:GLN:HG2	1.89	0.54
1:A:622:HIS:HB2	1:A:625:GLN:HG2	1.90	0.54
1:B:628:PRO:O	1:B:631:ARG:NH1	2.36	0.54
2:H:53:VAL:HG23	2:H:59:THR:HG22	1.88	0.54
1:C:622:HIS:HB2	1:C:625:GLN:HG2	1.89	0.54
1:A:1097:THR:OG1	1:A:1098:HIS:ND1	2.36	0.54
1:A:613:ASN:OD1	4:A:1306:NAG:N2	2.42	0.53
2:F:98:VAL:HG21	2:F:111:PHE:HB3	1.89	0.53
3:E:37:TRP:HB2	3:E:50:ILE:HB	1.90	0.53
1:B:458:LEU:HD22	1:B:462:GLU:HG2	1.90	0.53
1:A:834:TYR:HE2	1:C:616:GLU:HB3	1.74	0.53
2:D:98:VAL:HG21	2:D:111:PHE:HB3	1.90	0.53
1:B:613:ASN:OD1	4:B:1306:NAG:N2	2.42	0.53
3:L:37:TRP:HB2	3:L:50:ILE:HB	1.90	0.53
3:G:37:TRP:HB2	3:G:50:ILE:HB	1.91	0.53
1:C:613:ASN:OD1	4:C:1306:NAG:N2	2.42	0.53
1:A:458:LEU:HD22	1:A:462:GLU:HG2	1.90	0.52
1:C:458:LEU:HD22	1:C:462:GLU:HG2	1.90	0.52
3:G:81:GLN:HG3	3:G:83:GLU:H	1.74	0.52
1:B:616:GLU:HB3	1:C:834:TYR:HE2	1.74	0.52
3:L:42:PRO:HD2	3:L:42:PRO:O	2.10	0.52
1:A:616:GLU:HB3	1:B:834:TYR:HE2	1.74	0.51
1:B:516:HIS:CD2	1:B:517:ALA:H	2.28	0.51
1:B:1097:THR:OG1	1:B:1098:HIS:ND1	2.36	0.51
1:A:516:HIS:CD2	1:A:517:ALA:H	2.29	0.51
3:E:81:GLN:HG3	3:E:83:GLU:H	1.76	0.51
1:A:428:GLY:HA2	1:A:512:PHE:CD2	2.45	0.51
1:B:197:TYR:CZ	1:B:227:PRO:HB3	2.45	0.51
1:A:99:ARG:HH12	1:A:151:GLU:HG2	1.75	0.51
1:B:455:LYS:NZ	1:B:471:GLN:O	2.44	0.51
1:C:516:HIS:CD2	1:C:517:ALA:H	2.29	0.51
1:A:197:TYR:CZ	1:A:227:PRO:HB3	2.45	0.51
1:C:99:ARG:HH12	1:C:151:GLU:HG2	1.75	0.51
1:C:428:GLY:HA2	1:C:512:PHE:CD2	2.45	0.51
1:C:808:LYS:NZ	1:C:817:ASP:OD2	2.26	0.50
1:C:62:PHE:O	1:C:261:ALA:HA	2.11	0.50
1:A:62:PHE:O	1:A:261:ALA:HA	2.11	0.50
1:C:197:TYR:CZ	1:C:227:PRO:HB3	2.45	0.50
1:B:99:ARG:HH12	1:B:151:GLU:HG2	1.75	0.50
1:B:428:GLY:HA2	1:B:512:PHE:CD2	2.45	0.50
1:A:455:LYS:NZ	1:A:471:GLN:O	2.44	0.50

*Continued on next page...*

*Continued from previous page...*

Atom-1	Atom-2	Interatomic distance (Å)	Clash overlap (Å)
1:B:62:PHE:O	1:B:261:ALA:HA	2.11	0.50
1:A:753:TYR:OH	1:A:991:ASP:OD1	2.27	0.49
1:C:455:LYS:NZ	1:C:471:GLN:O	2.44	0.49
3:L:18:ILE:HD11	3:L:77:ILE:HD12	1.95	0.49
1:B:61:TRP:HE1	1:B:261:ALA:HB1	1.78	0.48
2:H:8:GLY:HA3	2:H:20:LEU:HD22	1.94	0.48
1:B:804:PRO:HG3	1:B:872:SER:HB2	1.95	0.48
1:A:61:TRP:HE1	1:A:261:ALA:HB1	1.78	0.48
1:B:835:GLY:N	1:B:838:LEU:HG	2.28	0.48
2:F:81:SER:HB2	2:F:83:LYS:NZ	2.28	0.48
1:B:823:VAL:HB	1:B:1054:PRO:HG2	1.96	0.48
1:C:61:TRP:HE1	1:C:261:ALA:HB1	1.79	0.48
1:A:804:PRO:HG3	1:A:872:SER:HB2	1.95	0.48
2:F:4:LEU:HG	2:F:24:VAL:HG22	1.96	0.48
1:C:712:PRO:HA	1:C:1069:GLU:HA	1.96	0.48
1:B:712:PRO:HA	1:B:1069:GLU:HA	1.96	0.47
1:C:823:VAL:HB	1:C:1054:PRO:HG2	1.96	0.47
1:C:1073:THR:HB	1:C:1094:SER:HB3	1.97	0.47
1:A:315:PHE:CD1	1:A:618:PRO:HG3	2.50	0.47
1:A:823:VAL:HB	1:A:1054:PRO:HG2	1.96	0.47
3:E:28:ASP:OD1	3:E:29:VAL:N	2.47	0.47
1:C:753:TYR:OH	1:C:991:ASP:OD1	2.27	0.47
1:C:835:GLY:N	1:C:838:LEU:HG	2.28	0.47
1:A:656:SER:HB3	1:A:695:SER:HB2	1.96	0.47
1:B:315:PHE:CD1	1:B:618:PRO:HG3	2.50	0.47
1:B:1073:THR:HB	1:B:1094:SER:HB3	1.97	0.47
1:C:804:PRO:HG3	1:C:872:SER:HB2	1.95	0.47
2:D:4:LEU:HG	2:D:24:VAL:HG22	1.96	0.47
2:F:12:VAL:HG11	2:F:87:VAL:HG21	1.97	0.47
1:C:315:PHE:CD1	1:C:618:PRO:HG3	2.50	0.47
1:C:656:SER:HB3	1:C:695:SER:HB2	1.97	0.47
3:L:87:ASP:OD1	3:L:106:LYS:HG2	2.15	0.47
2:D:12:VAL:HG11	2:D:87:VAL:HG21	1.97	0.46
3:G:18:ILE:HD11	3:G:77:ILE:HD12	1.96	0.46
1:A:712:PRO:HA	1:A:1069:GLU:HA	1.96	0.46
2:H:12:VAL:HG11	2:H:87:VAL:HG21	1.98	0.46
3:L:28:ASP:OD1	3:L:29:VAL:N	2.46	0.46
1:B:656:SER:HB3	1:B:695:SER:HB2	1.97	0.46
1:A:351:ASN:O	1:A:395:ASP:HA	2.16	0.46
1:C:351:ASN:O	1:C:395:ASP:HA	2.16	0.46
1:A:1073:THR:HB	1:A:1094:SER:HB3	1.96	0.46

*Continued on next page...*



*Continued from previous page...*

Atom-1	Atom-2	Interatomic distance (Å)	Clash overlap (Å)
3:E:18:ILE:HD11	3:E:77:ILE:HD12	1.97	0.46
1:B:192:LYS:HE2	1:B:201:TYR:HE1	1.81	0.46
1:B:712:PRO:HG3	1:B:1066:PRO:HB3	1.97	0.46
1:C:712:PRO:HG3	1:C:1066:PRO:HB3	1.97	0.46
1:A:233:THR:HG23	1:A:234:ARG:HG3	1.99	0.45
1:C:233:THR:HG23	1:C:234:ARG:HG3	1.98	0.45
3:G:28:ASP:OD1	3:G:29:VAL:N	2.46	0.45
1:B:36:PRO:HG3	1:B:48:THR:HG21	1.99	0.45
1:B:753:TYR:OH	1:B:991:ASP:OD1	2.27	0.45
1:A:712:PRO:HG3	1:A:1066:PRO:HB3	1.97	0.45
1:B:351:ASN:O	1:B:395:ASP:HA	2.16	0.45
2:H:80:PHE:CZ	2:H:97:CYS:HB2	2.52	0.45
1:C:808:LYS:HE2	1:C:808:LYS:HB3	1.83	0.45
2:D:8:GLY:HA3	2:D:20:LEU:HD22	1.99	0.45
1:B:233:THR:HG23	1:B:234:ARG:HG3	1.99	0.45
3:G:57:PRO:HD2	3:G:60:VAL:HG21	1.99	0.44
1:A:835:GLY:N	1:A:838:LEU:HG	2.28	0.44
1:A:838:LEU:HD22	1:C:585:THR:HG21	2.00	0.44
2:H:39:ILE:HD12	2:H:98:VAL:HG11	1.99	0.44
1:B:301:LYS:HB3	1:B:301:LYS:HE2	1.61	0.44
1:A:86:GLY:HA3	1:A:267:LEU:HD12	2.00	0.44
1:C:192:LYS:HE2	1:C:201:TYR:HE1	1.81	0.44
1:A:36:PRO:HG3	1:A:48:THR:HG21	1.98	0.44
1:B:289:ALA:HB1	1:B:629:THR:OG1	2.18	0.44
1:A:192:LYS:HE2	1:A:201:TYR:HE1	1.81	0.44
1:C:289:ALA:HB1	1:C:629:THR:OG1	2.18	0.44
1:B:86:GLY:HA3	1:B:267:LEU:HD12	2.00	0.43
1:A:315:PHE:HA	1:A:628:PRO:HD3	2.01	0.43
1:C:315:PHE:HA	1:C:628:PRO:HD3	2.01	0.43
1:A:578:THR:HB	3:L:34:LEU:HD21	2.01	0.43
2:D:39:ILE:HD12	2:D:98:VAL:HG11	1.99	0.43
1:B:1087:PRO:HD2	1:C:910:GLN:NE2	2.33	0.43
2:D:80:PHE:CZ	2:D:97:CYS:HB2	2.54	0.43
3:G:34:LEU:HD21	1:C:578:THR:HB	2.00	0.43
1:C:1035:LYS:HD3	1:C:1035:LYS:HA	1.78	0.43
3:G:6:GLN:NE2	3:G:88:TYR:O	2.52	0.43
1:C:36:PRO:HG3	1:C:48:THR:HG21	1.99	0.43
1:A:1087:PRO:HD2	1:B:910:GLN:NE2	2.34	0.43
2:F:112:ASP:OD1	2:F:112:ASP:N	2.51	0.43
1:B:315:PHE:HA	1:B:628:PRO:HD3	2.01	0.43
1:C:530:LEU:HD21	1:C:582:LEU:HD11	2.01	0.43

*Continued on next page...*

*Continued from previous page...*

Atom-1	Atom-2	Interatomic distance (Å)	Clash overlap (Å)
1:C:86:GLY:HA3	1:C:267:LEU:HD12	2.00	0.42
1:A:289:ALA:HB1	1:A:629:THR:OG1	2.18	0.42
2:F:39:ILE:HD12	2:F:98:VAL:HG11	2.01	0.42
2:F:80:PHE:CZ	2:F:97:CYS:HB2	2.54	0.42
1:B:585:THR:HG21	1:C:838:LEU:HD22	2.01	0.42
1:B:783:LYS:H	1:B:783:LYS:HG2	1.61	0.42
3:E:49:MET:HE3	3:E:60:VAL:HG13	2.01	0.42
3:G:91:CYS:HB2	3:G:101:PHE:CE1	2.55	0.42
1:B:837:CYS:HB3	1:B:852:PHE:CZ	2.55	0.42
1:C:837:CYS:HB3	1:C:852:PHE:CZ	2.55	0.42
1:A:530:LEU:HD21	1:A:582:LEU:HD11	2.01	0.42
1:A:837:CYS:HB3	1:A:852:PHE:CZ	2.55	0.42
1:B:530:LEU:HD21	1:B:582:LEU:HD11	2.01	0.42
1:C:867:ILE:O	1:C:871:THR:HG23	2.20	0.42
2:H:112:ASP:OD1	2:H:112:ASP:N	2.51	0.42
3:G:49:MET:HE1	3:G:60:VAL:HG13	2.01	0.42
1:B:867:ILE:O	1:B:871:THR:HG23	2.20	0.42
1:A:585:THR:HG21	1:B:838:LEU:HD22	2.01	0.41
1:A:1035:LYS:HA	1:A:1035:LYS:HD3	1.78	0.41
1:B:618:PRO:HB2	1:B:626:LEU:HD21	2.02	0.41
2:H:4:LEU:HG	2:H:24:VAL:HG22	2.01	0.41
1:C:318:GLN:HB2	1:C:625:GLN:HA	2.03	0.41
3:E:91:CYS:HB2	3:E:101:PHE:CE1	2.55	0.41
1:A:910:GLN:NE2	1:C:1087:PRO:HD2	2.35	0.41
1:A:867:ILE:O	1:A:871:THR:HG23	2.20	0.41
1:C:961:LYS:HE2	1:C:961:LYS:HB2	1.87	0.41
3:L:91:CYS:HB2	3:L:101:PHE:CE1	2.55	0.41
2:F:95:TYR:O	2:F:117:GLY:HA2	2.21	0.41
2:H:40:ARG:HG3	2:H:42:PRO:HD3	2.02	0.41
1:B:327:PRO:HD3	1:B:541:ASN:OD1	2.21	0.41
1:C:1138:LEU:HD13	1:C:1138:LEU:O	2.21	0.41
2:D:16:GLN:O	2:D:87:VAL:HG23	2.21	0.41
2:D:74:ASP:HB2	2:D:79:ASN:OD1	2.21	0.41
1:B:393:TYR:HB2	1:B:511:SER:HB2	2.03	0.41
1:B:808:LYS:HE2	1:B:808:LYS:HB3	1.83	0.41
1:C:618:PRO:HB2	1:C:626:LEU:HD21	2.03	0.41
1:B:318:GLN:HB2	1:B:625:GLN:HA	2.03	0.41
1:A:129:GLU:HB2	1:A:161:ASN:O	2.21	0.40
1:A:516:HIS:CG	1:A:517:ALA:H	2.39	0.40
1:B:898:GLN:O	1:B:902:ARG:HG2	2.21	0.40
1:A:192:LYS:HE2	1:A:201:TYR:CE1	2.56	0.40

*Continued on next page...*

Continued from previous page...

Atom-1	Atom-2	Interatomic distance (Å)	Clash overlap (Å)
1:A:318:GLN:HB2	1:A:625:GLN:HA	2.03	0.40
1:A:393:TYR:HB2	1:A:511:SER:HB2	2.03	0.40
1:A:642:THR:O	1:B:831:ILE:HD11	2.21	0.40
2:H:94:VAL:HG22	2:H:119:MET:HG2	2.03	0.40
2:D:116:GLN:HG2	2:D:117:GLY:N	2.36	0.40
1:B:516:HIS:CG	1:B:517:ALA:H	2.39	0.40
1:C:783:LYS:H	1:C:783:LYS:HG2	1.61	0.40
1:A:819:LEU:HD22	1:A:942:LEU:HD11	2.03	0.40
1:C:393:TYR:HB2	1:C:511:SER:HB2	2.03	0.40
1:A:301:LYS:HE2	1:A:301:LYS:HB3	1.61	0.40
2:D:95:TYR:O	2:D:117:GLY:HA2	2.22	0.40
1:C:898:GLN:O	1:C:902:ARG:HG2	2.21	0.40
1:A:1138:LEU:O	1:A:1138:LEU:HD13	2.21	0.40
2:H:74:ASP:HB2	2:H:79:ASN:OD1	2.21	0.40
3:E:6:GLN:NE2	3:E:88:TYR:O	2.54	0.40
1:B:712:PRO:HD3	1:C:891:LEU:HD13	2.04	0.40

There are no symmetry-related clashes.

## 5.3 Torsion angles [i](#)

### 5.3.1 Protein backbone [i](#)

In the following table, the Percentiles column shows the percent Ramachandran outliers of the chain as a percentile score with respect to all PDB entries followed by that with respect to all EM entries.

The Analysed column shows the number of residues for which the backbone conformation was analysed, and the total number of residues.

Mol	Chain	Analysed	Favoured	Allowed	Outliers	Percentiles	
1	A	1042/1285 (81%)	1012 (97%)	30 (3%)	0	100	100
1	B	1042/1285 (81%)	1013 (97%)	29 (3%)	0	100	100
1	C	1042/1285 (81%)	1013 (97%)	29 (3%)	0	100	100
2	D	122/124 (98%)	117 (96%)	5 (4%)	0	100	100
2	F	122/124 (98%)	116 (95%)	6 (5%)	0	100	100
2	H	122/124 (98%)	116 (95%)	6 (5%)	0	100	100
3	E	107/110 (97%)	105 (98%)	2 (2%)	0	100	100

Continued on next page...

Continued from previous page...

Mol	Chain	Analysed	Favoured	Allowed	Outliers	Percentiles	
3	G	107/110 (97%)	105 (98%)	2 (2%)	0	100	100
3	L	107/110 (97%)	105 (98%)	2 (2%)	0	100	100
All	All	3813/4557 (84%)	3702 (97%)	111 (3%)	0	100	100

There are no Ramachandran outliers to report.

### 5.3.2 Protein sidechains [i](#)

In the following table, the Percentiles column shows the percent sidechain outliers of the chain as a percentile score with respect to all PDB entries followed by that with respect to all EM entries.

The Analysed column shows the number of residues for which the sidechain conformation was analysed, and the total number of residues.

Mol	Chain	Analysed	Rotameric	Outliers	Percentiles	
1	A	920/1110 (83%)	908 (99%)	12 (1%)	69	81
1	B	920/1110 (83%)	908 (99%)	12 (1%)	69	81
1	C	920/1110 (83%)	907 (99%)	13 (1%)	67	80
2	D	107/107 (100%)	104 (97%)	3 (3%)	43	56
2	F	107/107 (100%)	101 (94%)	6 (6%)	21	25
2	H	107/107 (100%)	102 (95%)	5 (5%)	26	33
3	E	90/91 (99%)	88 (98%)	2 (2%)	52	65
3	G	90/91 (99%)	88 (98%)	2 (2%)	52	65
3	L	90/91 (99%)	88 (98%)	2 (2%)	52	65
All	All	3351/3924 (85%)	3294 (98%)	57 (2%)	62	74

All (57) residues with a non-rotameric sidechain are listed below:

Mol	Chain	Res	Type
1	A	138	LEU
1	A	169	SER
1	A	199	LYS
1	A	425	ASP
1	A	553	ASN
1	A	555	LYS
1	A	596	THR
1	A	627	THR

Continued on next page...

*Continued from previous page...*

<b>Mol</b>	<b>Chain</b>	<b>Res</b>	<b>Type</b>
1	A	656	SER
1	A	658	GLU
1	A	782	VAL
1	A	811	LYS
2	H	3	GLN
2	H	25	SER
2	H	40	ARG
2	H	92	THR
2	H	116	GLN
3	L	80	LEU
3	L	87	ASP
2	D	40	ARG
2	D	92	THR
2	D	119	MET
3	E	87	ASP
3	E	106	LYS
2	F	9	PRO
2	F	13	LYS
2	F	25	SER
2	F	40	ARG
2	F	83	LYS
2	F	92	THR
3	G	47	LYS
3	G	87	ASP
1	B	138	LEU
1	B	169	SER
1	B	199	LYS
1	B	425	ASP
1	B	553	ASN
1	B	555	LYS
1	B	596	THR
1	B	627	THR
1	B	656	SER
1	B	658	GLU
1	B	782	VAL
1	B	811	LYS
1	C	138	LEU
1	C	169	SER
1	C	199	LYS
1	C	372	PHE
1	C	425	ASP
1	C	553	ASN

*Continued on next page...*

*Continued from previous page...*

Mol	Chain	Res	Type
1	C	555	LYS
1	C	596	THR
1	C	627	THR
1	C	656	SER
1	C	658	GLU
1	C	782	VAL
1	C	811	LYS

Sometimes sidechains can be flipped to improve hydrogen bonding and reduce clashes. All (3) such sidechains are listed below:

Mol	Chain	Res	Type
1	A	932	GLN
1	B	932	GLN
1	C	932	GLN

### 5.3.3 RNA [i](#)

There are no RNA molecules in this entry.

### 5.4 Non-standard residues in protein, DNA, RNA chains [i](#)

There are no non-standard protein/DNA/RNA residues in this entry.

### 5.5 Carbohydrates [i](#)

There are no monosaccharides in this entry.

### 5.6 Ligand geometry [i](#)

30 ligands are modelled in this entry.

In the following table, the Counts columns list the number of bonds (or angles) for which Mogul statistics could be retrieved, the number of bonds (or angles) that are observed in the model and the number of bonds (or angles) that are defined in the Chemical Component Dictionary. The Link column lists molecule types, if any, to which the group is linked. The Z score for a bond length (or angle) is the number of standard deviations the observed value is removed from the expected value. A bond length (or angle) with  $|Z| > 2$  is considered an outlier worth inspection. RMSZ is the root-mean-square of all Z scores of the bond lengths (or angles).

Mol	Type	Chain	Res	Link	Bond lengths			Bond angles		
					Counts	RMSZ	# Z  > 2	Counts	RMSZ	# Z  > 2
4	NAG	C	1305	1	14,14,15	0.23	0	17,19,21	0.47	0
4	NAG	A	1305	1	14,14,15	0.23	0	17,19,21	0.48	0
4	NAG	C	1303	1	14,14,15	0.34	0	17,19,21	0.55	0
4	NAG	B	1306	1	14,14,15	0.42	0	17,19,21	0.50	0
4	NAG	C	1301	1	14,14,15	0.20	0	17,19,21	0.36	0
4	NAG	B	1308	1	14,14,15	0.20	0	17,19,21	0.41	0
4	NAG	A	1306	1	14,14,15	0.43	0	17,19,21	0.51	0
4	NAG	C	1310	1	14,14,15	0.30	0	17,19,21	0.46	0
4	NAG	A	1310	1	14,14,15	0.30	0	17,19,21	0.47	0
4	NAG	C	1306	1	14,14,15	0.44	0	17,19,21	0.51	0
4	NAG	B	1309	1	14,14,15	0.32	0	17,19,21	0.52	0
4	NAG	A	1307	1	14,14,15	0.31	0	17,19,21	0.49	0
4	NAG	A	1302	1	14,14,15	0.30	0	17,19,21	0.51	0
4	NAG	C	1304	1	14,14,15	0.20	0	17,19,21	0.46	0
4	NAG	A	1303	1	14,14,15	0.34	0	17,19,21	0.55	0
4	NAG	B	1305	1	14,14,15	0.23	0	17,19,21	0.47	0
4	NAG	C	1309	1	14,14,15	0.31	0	17,19,21	0.52	0
4	NAG	A	1309	1	14,14,15	0.32	0	17,19,21	0.52	0
4	NAG	A	1301	1	14,14,15	0.19	0	17,19,21	0.36	0
4	NAG	A	1304	1	14,14,15	0.19	0	17,19,21	0.46	0
4	NAG	B	1301	1	14,14,15	0.19	0	17,19,21	0.36	0
4	NAG	C	1308	1	14,14,15	0.20	0	17,19,21	0.41	0
4	NAG	A	1308	1	14,14,15	0.20	0	17,19,21	0.41	0
4	NAG	B	1302	1	14,14,15	0.31	0	17,19,21	0.51	0
4	NAG	B	1307	1	14,14,15	0.33	0	17,19,21	0.49	0
4	NAG	B	1304	1	14,14,15	0.19	0	17,19,21	0.46	0
4	NAG	B	1303	1	14,14,15	0.34	0	17,19,21	0.55	0
4	NAG	C	1307	1	14,14,15	0.31	0	17,19,21	0.49	0
4	NAG	C	1302	1	14,14,15	0.30	0	17,19,21	0.51	0
4	NAG	B	1310	1	14,14,15	0.30	0	17,19,21	0.47	0

In the following table, the Chirals column lists the number of chiral outliers, the number of chiral centers analysed, the number of these observed in the model and the number defined in the Chemical Component Dictionary. Similar counts are reported in the Torsion and Rings columns. '-' means no outliers of that kind were identified.

Mol	Type	Chain	Res	Link	Chirals	Torsions	Rings
4	NAG	C	1305	1	-	0/6/23/26	0/1/1/1
4	NAG	A	1305	1	-	0/6/23/26	0/1/1/1
4	NAG	C	1303	1	-	2/6/23/26	0/1/1/1
4	NAG	B	1306	1	-	3/6/23/26	0/1/1/1
4	NAG	C	1301	1	-	0/6/23/26	0/1/1/1

*Continued on next page...*

*Continued from previous page...*

Mol	Type	Chain	Res	Link	Chirals	Torsions	Rings
4	NAG	B	1308	1	-	0/6/23/26	0/1/1/1
4	NAG	A	1306	1	-	3/6/23/26	0/1/1/1
4	NAG	C	1310	1	-	0/6/23/26	0/1/1/1
4	NAG	A	1310	1	-	0/6/23/26	0/1/1/1
4	NAG	C	1306	1	-	3/6/23/26	0/1/1/1
4	NAG	B	1309	1	-	0/6/23/26	0/1/1/1
4	NAG	A	1307	1	-	4/6/23/26	0/1/1/1
4	NAG	A	1302	1	-	2/6/23/26	0/1/1/1
4	NAG	C	1304	1	-	2/6/23/26	0/1/1/1
4	NAG	A	1303	1	-	2/6/23/26	0/1/1/1
4	NAG	B	1305	1	-	0/6/23/26	0/1/1/1
4	NAG	C	1309	1	-	0/6/23/26	0/1/1/1
4	NAG	A	1309	1	-	0/6/23/26	0/1/1/1
4	NAG	A	1301	1	-	0/6/23/26	0/1/1/1
4	NAG	A	1304	1	-	2/6/23/26	0/1/1/1
4	NAG	B	1301	1	-	0/6/23/26	0/1/1/1
4	NAG	C	1308	1	-	0/6/23/26	0/1/1/1
4	NAG	A	1308	1	-	0/6/23/26	0/1/1/1
4	NAG	B	1302	1	-	2/6/23/26	0/1/1/1
4	NAG	B	1307	1	-	4/6/23/26	0/1/1/1
4	NAG	B	1304	1	-	2/6/23/26	0/1/1/1
4	NAG	B	1303	1	-	2/6/23/26	0/1/1/1
4	NAG	C	1307	1	-	4/6/23/26	0/1/1/1
4	NAG	C	1302	1	-	2/6/23/26	0/1/1/1
4	NAG	B	1310	1	-	0/6/23/26	0/1/1/1

There are no bond length outliers.

There are no bond angle outliers.

There are no chirality outliers.

All (39) torsion outliers are listed below:

Mol	Chain	Res	Type	Atoms
4	A	1302	NAG	O5-C5-C6-O6
4	B	1302	NAG	O5-C5-C6-O6
4	C	1302	NAG	O5-C5-C6-O6
4	A	1307	NAG	C8-C7-N2-C2
4	A	1307	NAG	O7-C7-N2-C2
4	B	1307	NAG	C8-C7-N2-C2

*Continued on next page...*



*Continued from previous page...*

Mol	Chain	Res	Type	Atoms
4	B	1307	NAG	O7-C7-N2-C2
4	C	1307	NAG	C8-C7-N2-C2
4	C	1307	NAG	O7-C7-N2-C2
4	B	1302	NAG	C4-C5-C6-O6
4	A	1302	NAG	C4-C5-C6-O6
4	C	1302	NAG	C4-C5-C6-O6
4	A	1307	NAG	O5-C5-C6-O6
4	B	1307	NAG	O5-C5-C6-O6
4	C	1307	NAG	O5-C5-C6-O6
4	A	1304	NAG	O5-C5-C6-O6
4	B	1304	NAG	O5-C5-C6-O6
4	C	1304	NAG	O5-C5-C6-O6
4	A	1304	NAG	C4-C5-C6-O6
4	A	1307	NAG	C4-C5-C6-O6
4	B	1304	NAG	C4-C5-C6-O6
4	B	1307	NAG	C4-C5-C6-O6
4	C	1304	NAG	C4-C5-C6-O6
4	C	1307	NAG	C4-C5-C6-O6
4	A	1306	NAG	C4-C5-C6-O6
4	B	1306	NAG	C4-C5-C6-O6
4	C	1306	NAG	C4-C5-C6-O6
4	A	1306	NAG	O5-C5-C6-O6
4	B	1306	NAG	O5-C5-C6-O6
4	C	1306	NAG	O5-C5-C6-O6
4	A	1303	NAG	C4-C5-C6-O6
4	C	1303	NAG	C4-C5-C6-O6
4	B	1303	NAG	C4-C5-C6-O6
4	A	1303	NAG	O5-C5-C6-O6
4	B	1303	NAG	O5-C5-C6-O6
4	C	1303	NAG	O5-C5-C6-O6
4	A	1306	NAG	C1-C2-N2-C7
4	B	1306	NAG	C1-C2-N2-C7
4	C	1306	NAG	C1-C2-N2-C7

There are no ring outliers.

3 monomers are involved in 3 short contacts:

Mol	Chain	Res	Type	Clashes	Symm-Clashes
4	B	1306	NAG	1	0
4	A	1306	NAG	1	0
4	C	1306	NAG	1	0

## 5.7 Other polymers [i](#)

There are no such residues in this entry.

## 5.8 Polymer linkage issues [i](#)

There are no chain breaks in this entry.

## 6 Map visualisation [i](#)

This section contains visualisations of the EMDB entry EMD-18807. These allow visual inspection of the internal detail of the map and identification of artifacts.

Images derived from a raw map, generated by summing the deposited half-maps, are presented below the corresponding image components of the primary map to allow further visual inspection and comparison with those of the primary map.

### 6.1 Orthogonal projections [i](#)

#### 6.1.1 Primary map

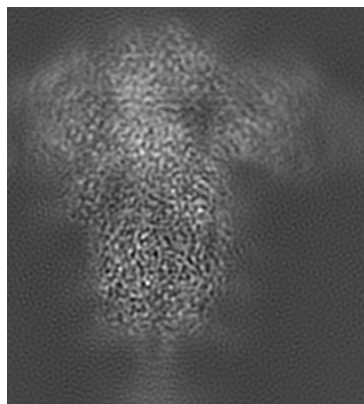

X

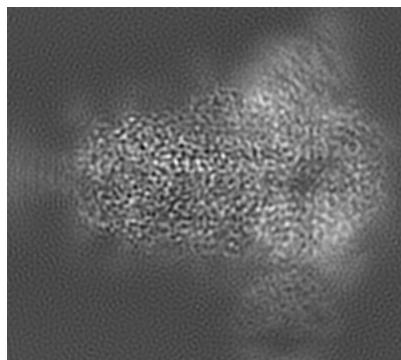

Y

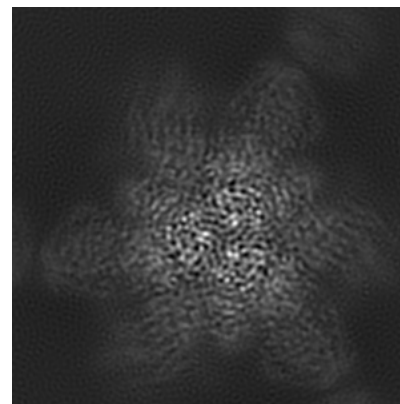

Z

#### 6.1.2 Raw map

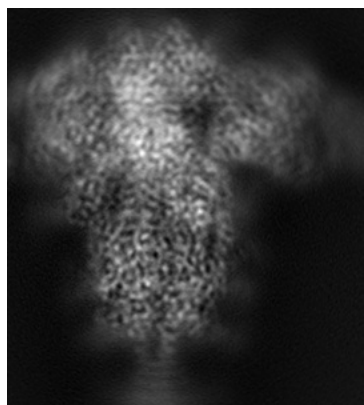

X

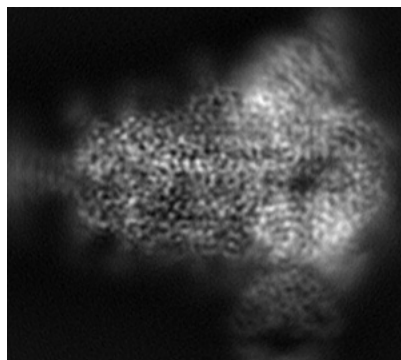

Y

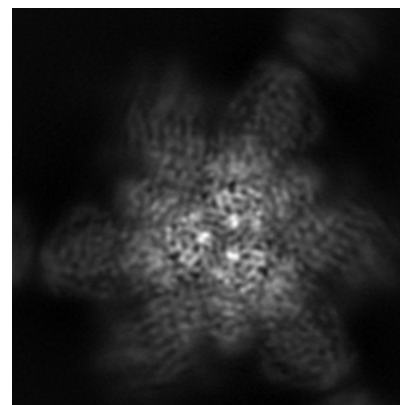

Z

The images above show the map projected in three orthogonal directions.

## 6.2 Central slices [i](#)

### 6.2.1 Primary map

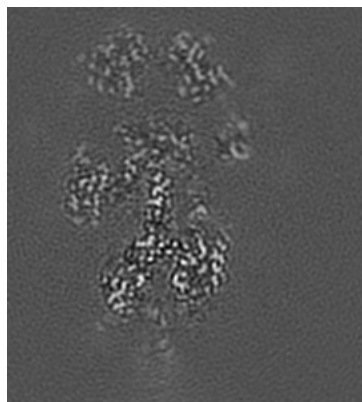

X Index: 112

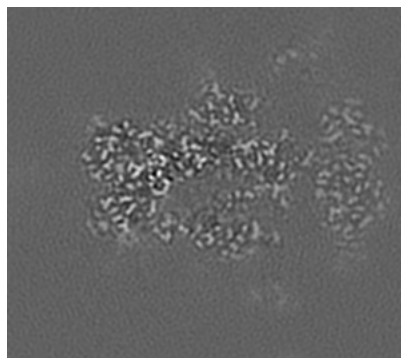

Y Index: 112

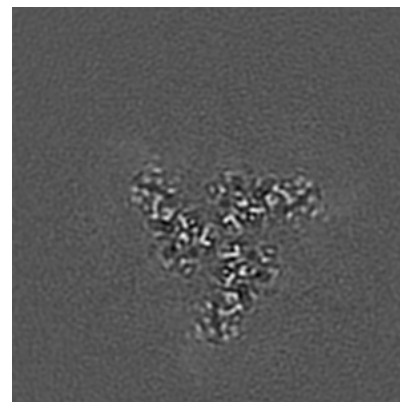

Z Index: 126

### 6.2.2 Raw map

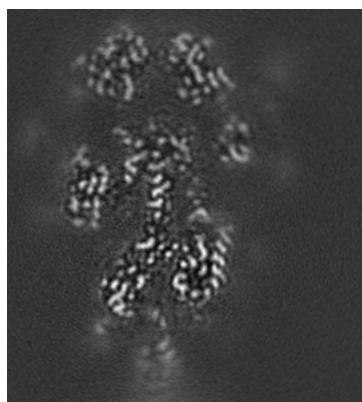

X Index: 112

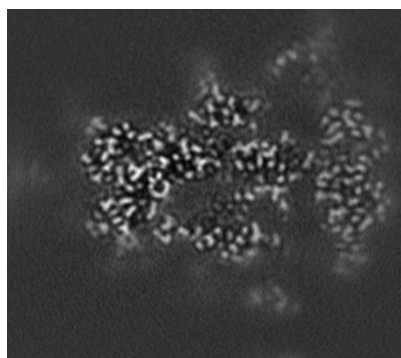

Y Index: 112

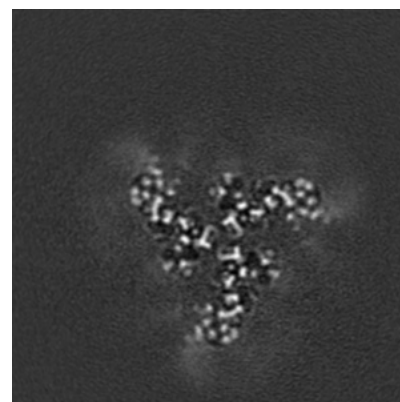

Z Index: 126

The images above show central slices of the map in three orthogonal directions.

## 6.3 Largest variance slices [i](#)

### 6.3.1 Primary map

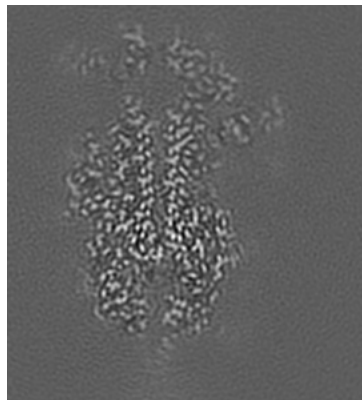

X Index: 125

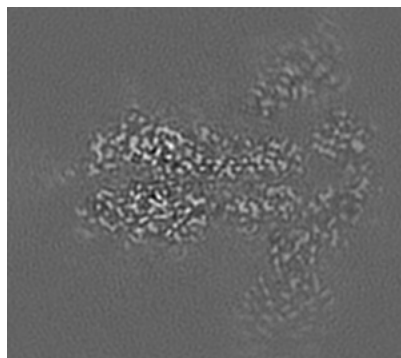

Y Index: 87

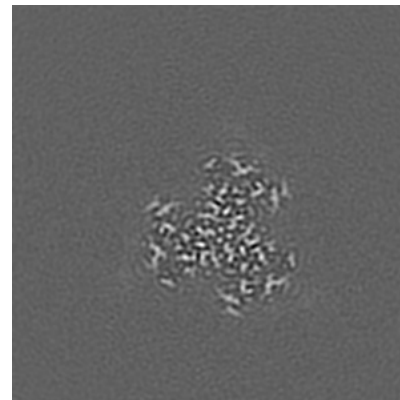

Z Index: 101

### 6.3.2 Raw map

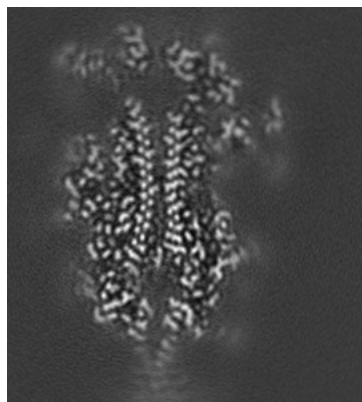

X Index: 124

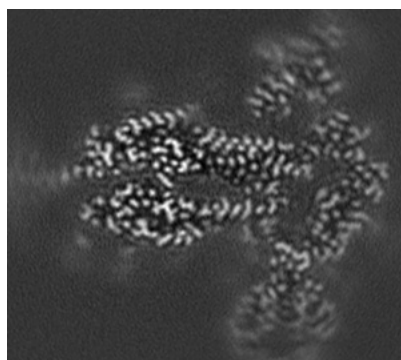

Y Index: 82

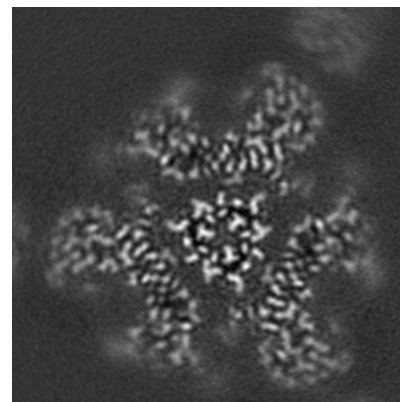

Z Index: 168

The images above show the largest variance slices of the map in three orthogonal directions.

## 6.4 Orthogonal standard-deviation projections (False-color) [i](#)

### 6.4.1 Primary map

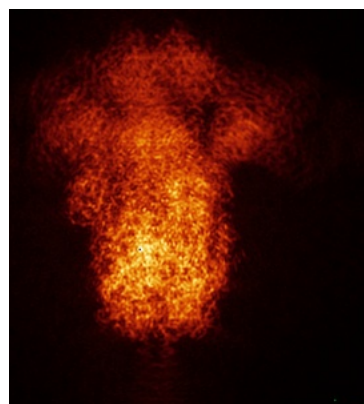

X

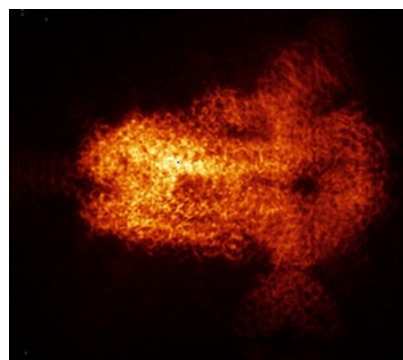

Y

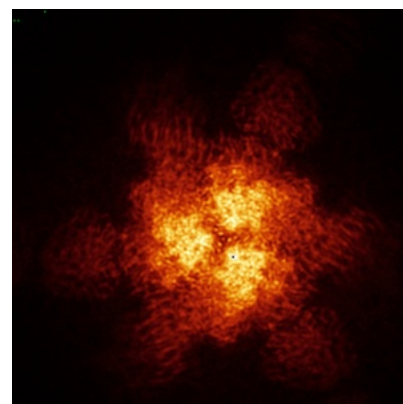

Z

### 6.4.2 Raw map

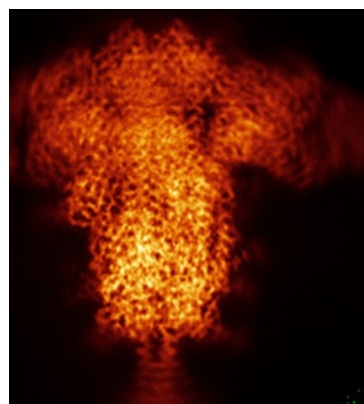

X

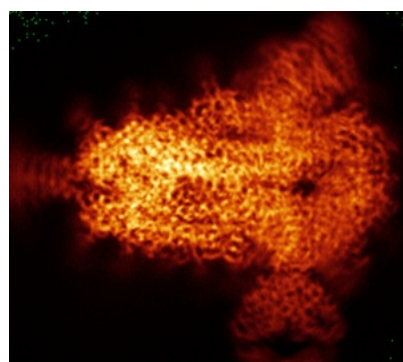

Y

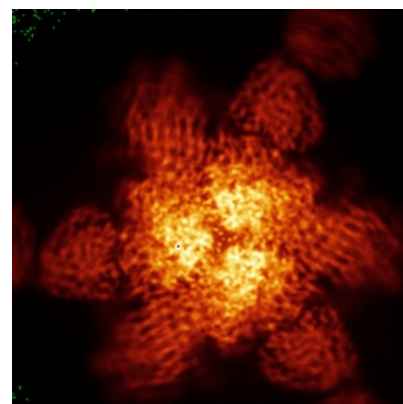

Z

The images above show the map standard deviation projections with false color in three orthogonal directions. Minimum values are shown in green, max in blue, and dark to light orange shades represent small to large values respectively.



## 6.5 Orthogonal surface views [i](#)

### 6.5.1 Primary map

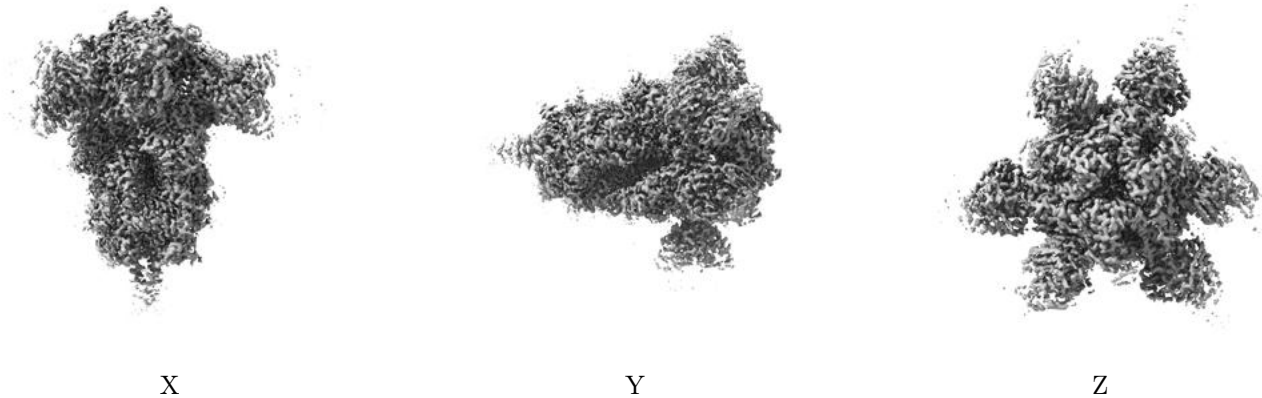

The images above show the 3D surface view of the map at the recommended contour level 0.148. These images, in conjunction with the slice images, may facilitate assessment of whether an appropriate contour level has been provided.

### 6.5.2 Raw map

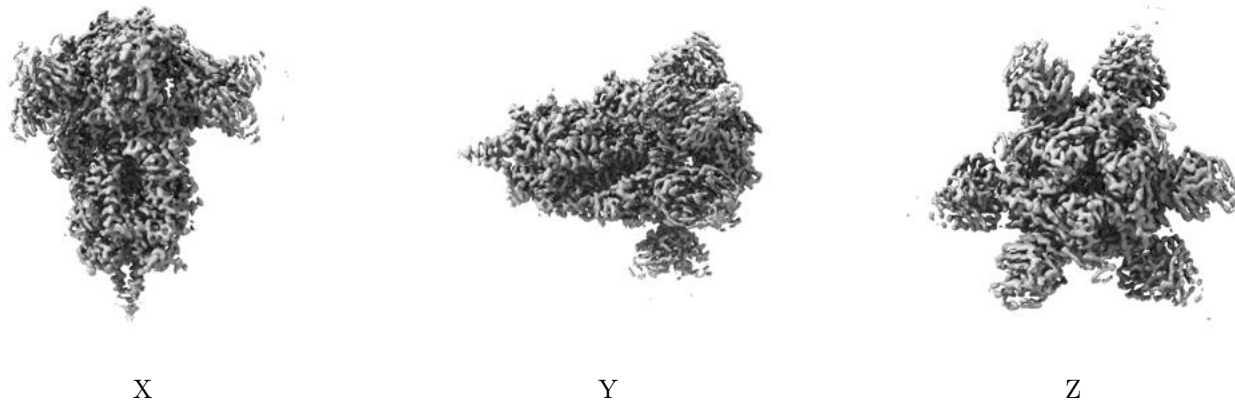

These images show the 3D surface of the raw map. The raw map's contour level was selected so that its surface encloses the same volume as the primary map does at its recommended contour level.

## 6.6 Mask visualisation [i](#)

This section was not generated. No masks/segmentation were deposited.

## 7 Map analysis [i](#)

This section contains the results of statistical analysis of the map.

### 7.1 Map-value distribution [i](#)

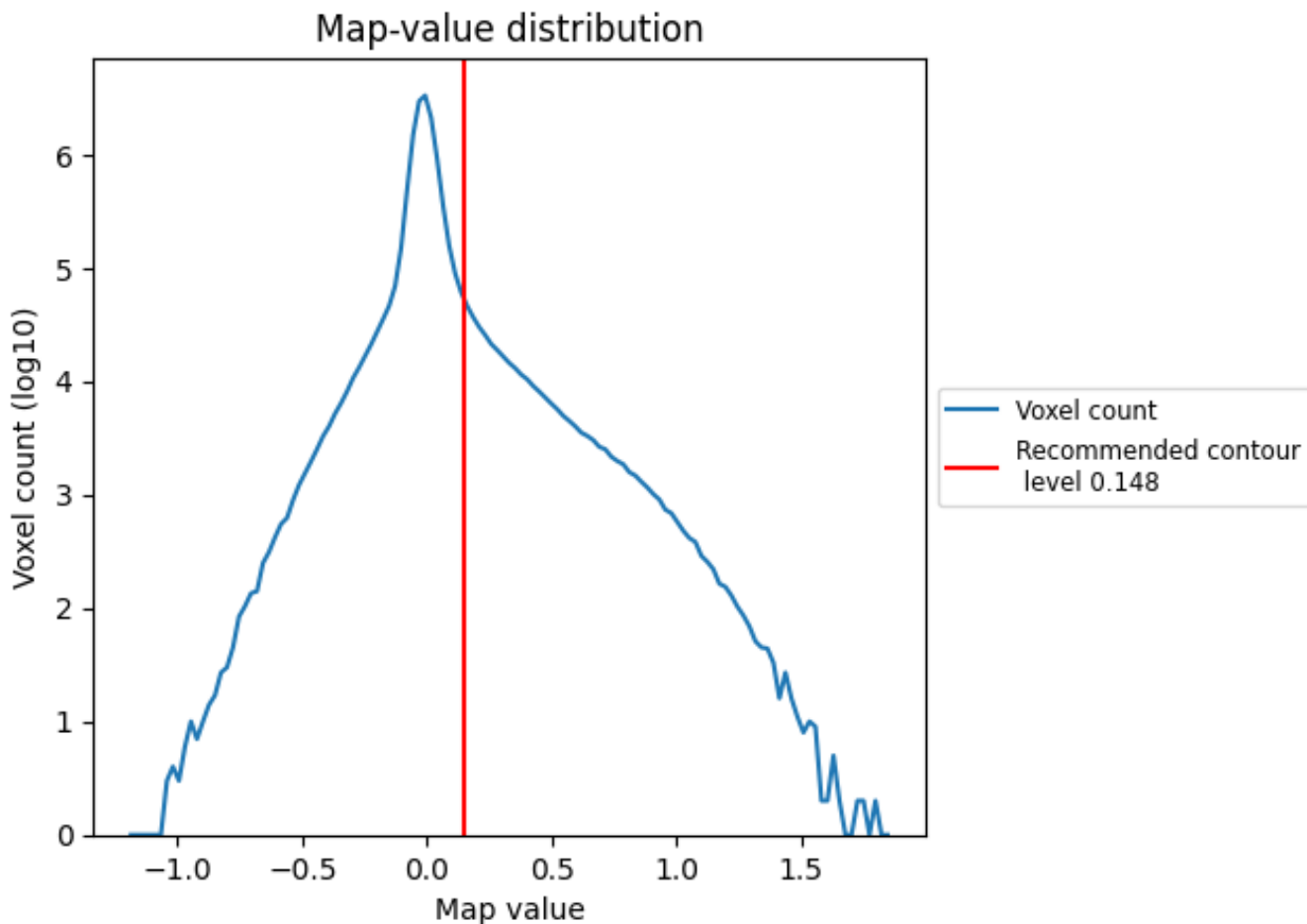

The map-value distribution is plotted in 128 intervals along the x-axis. The y-axis is logarithmic. A spike in this graph at zero usually indicates that the volume has been masked.



## 7.2 Volume estimate [i](#)

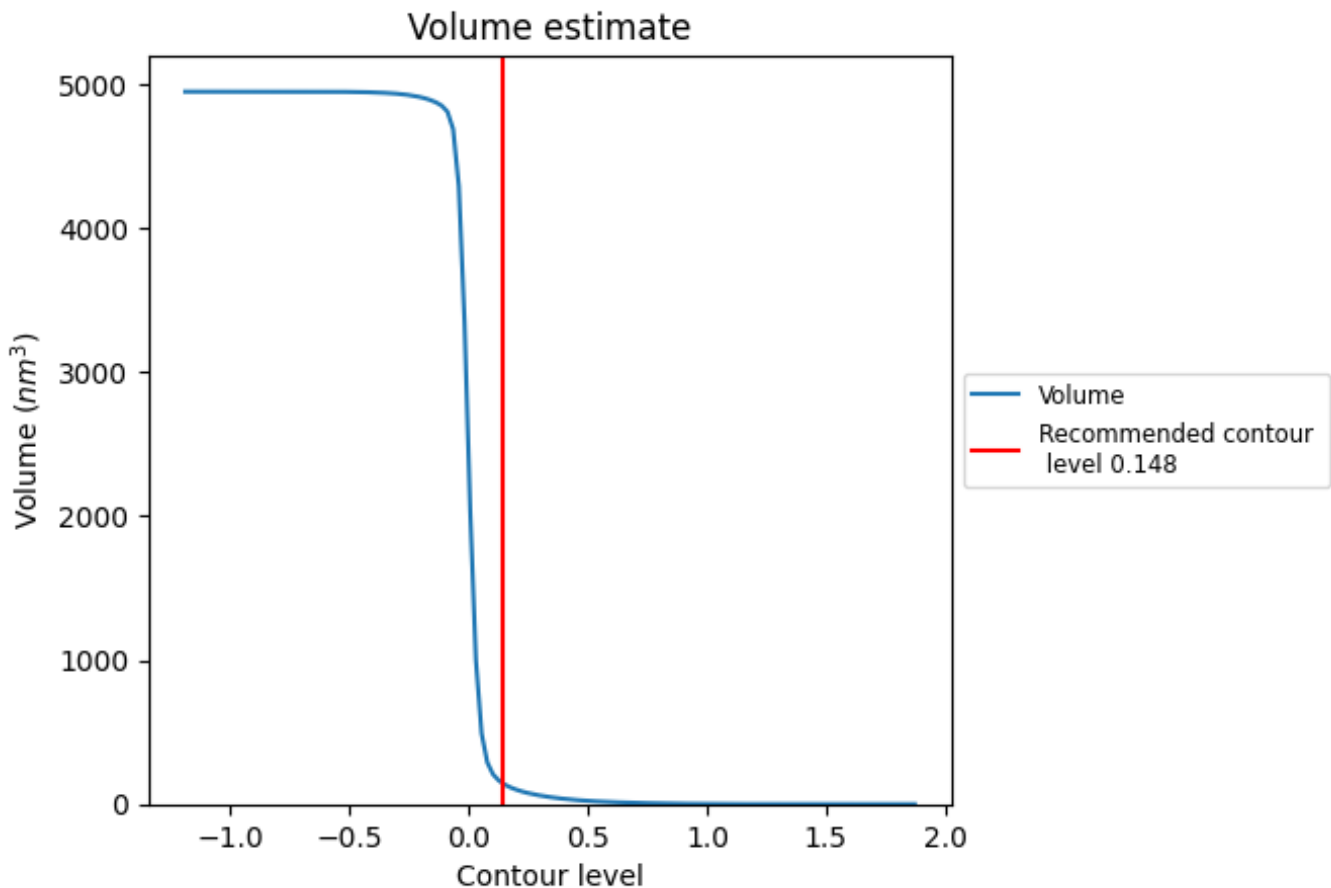

The volume at the recommended contour level is 141 nm<sup>3</sup>; this corresponds to an approximate mass of 128 kDa.

The volume estimate graph shows how the enclosed volume varies with the contour level. The recommended contour level is shown as a vertical line and the intersection between the line and the curve gives the volume of the enclosed surface at the given level.

## 7.3 Rotationally averaged power spectrum [i](#)

This section was not generated. The rotationally averaged power spectrum is only generated for cubic maps.

## 8 Fourier-Shell correlation [i](#)

Fourier-Shell Correlation (FSC) is the most commonly used method to estimate the resolution of single-particle and subtomogram-averaged maps. The shape of the curve depends on the imposed symmetry, mask and whether or not the two 3D reconstructions used were processed from a common reference. The reported resolution is shown as a black line. A curve is displayed for the half-bit criterion in addition to lines showing the 0.143 gold standard cut-off and 0.5 cut-off.

### 8.1 FSC [i](#)

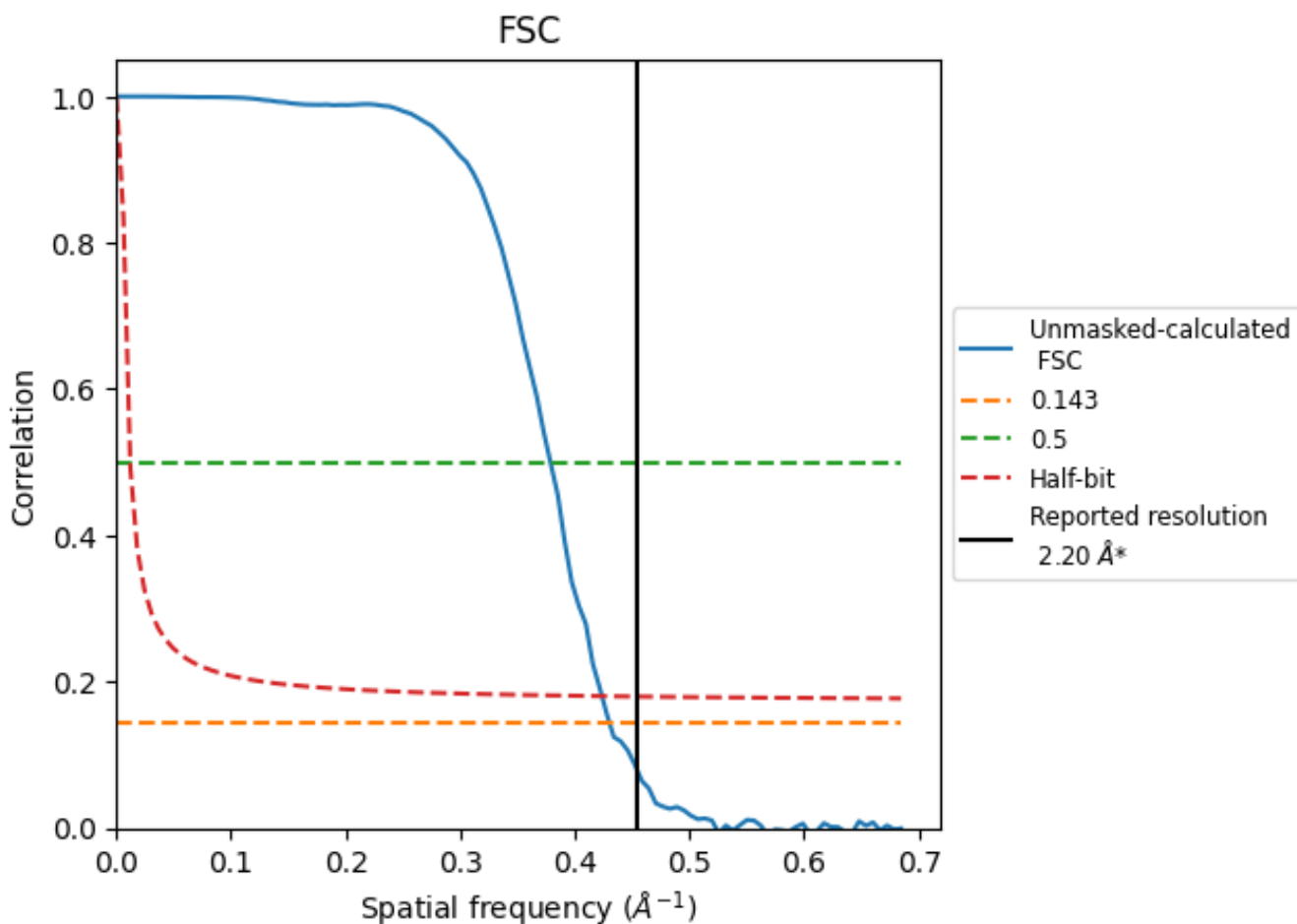

\*Reported resolution corresponds to spatial frequency of  $0.455 \text{\AA}^{-1}$

## 8.2 Resolution estimates [i](#)

Resolution estimate (Å)	Estimation criterion (FSC cut-off)		
	0.143	0.5	Half-bit
Reported by author	2.20	-	-
Author-provided FSC curve	-	-	-
Unmasked-calculated*	2.32	2.64	2.36

\*Resolution estimate based on FSC curve calculated by comparison of deposited half-maps.

## 9 Map-model fit [i](#)

This section contains information regarding the fit between EMDB map EMD-18807 and PDB model 8R1C. Per-residue inclusion information can be found in section 3 on page 14.

### 9.1 Map-model overlay [i](#)

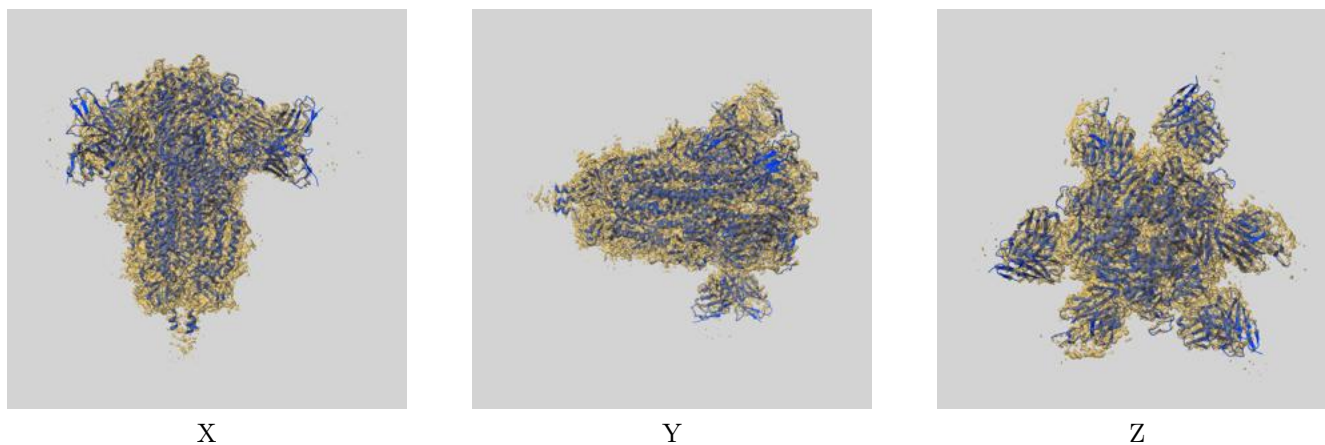

The images above show the 3D surface view of the map at the recommended contour level 0.148 at 50% transparency in yellow overlaid with a ribbon representation of the model coloured in blue. These images allow for the visual assessment of the quality of fit between the atomic model and the map.

## 9.2 Q-score mapped to coordinate model [\(i\)](#)

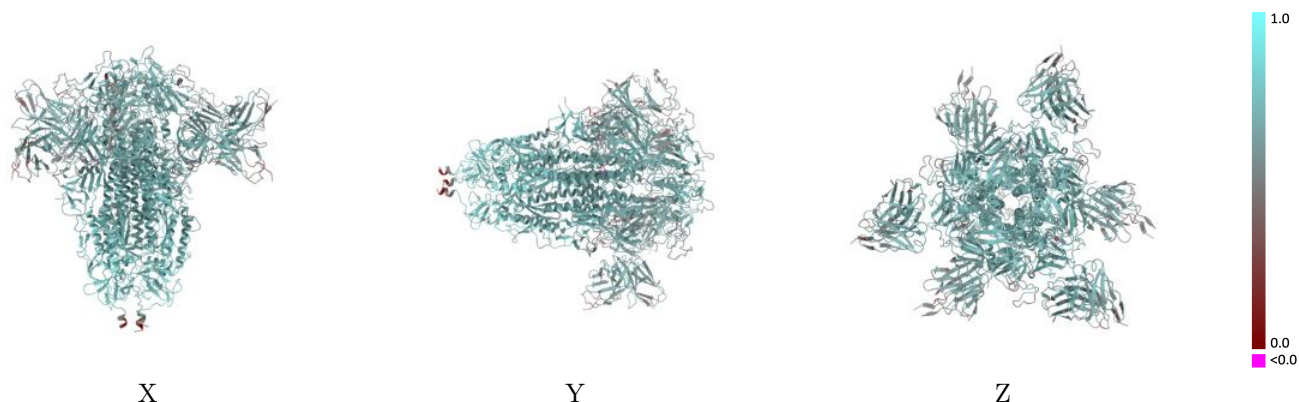

The images above show the model with each residue coloured according to its Q-score. This shows their resolvability in the map with higher Q-score values reflecting better resolvability. Please note: Q-score is calculating the resolvability of atoms, and thus high values are only expected at resolutions at which atoms can be resolved. Low Q-score values may therefore be expected for many entries.

## 9.3 Atom inclusion mapped to coordinate model [\(i\)](#)

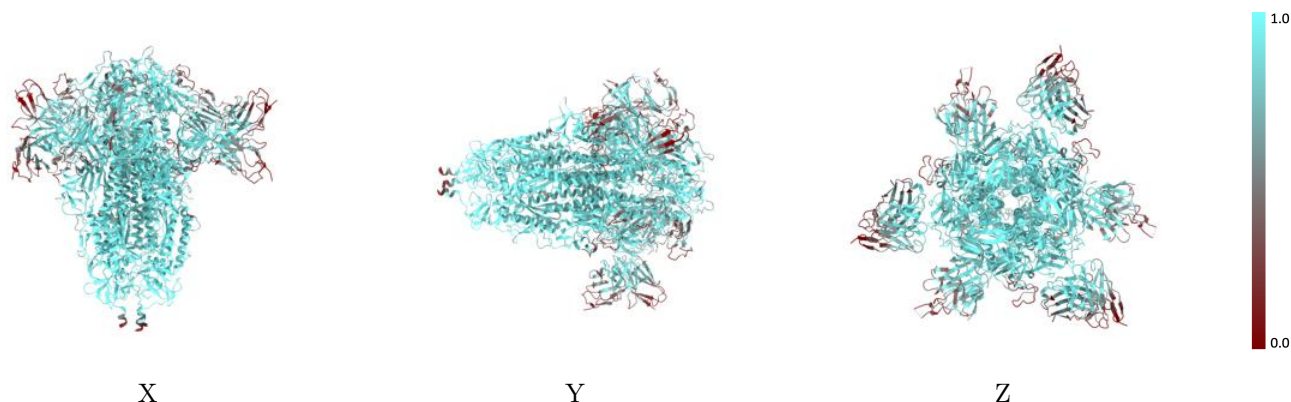

The images above show the model with each residue coloured according to its atom inclusion. This shows to what extent they are inside the map at the recommended contour level (0.148).



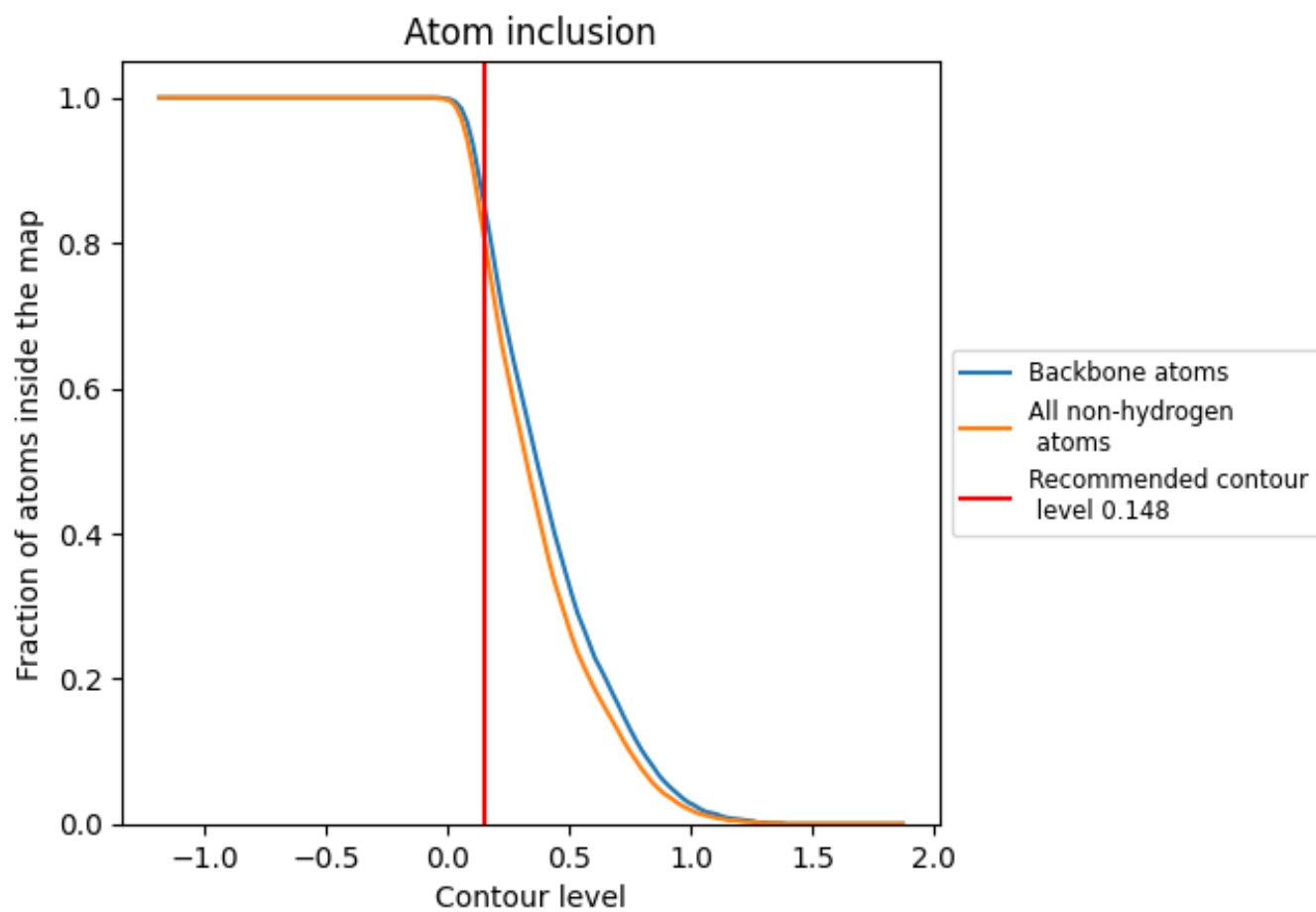

















## 9.4 Atom inclusion [i](#)



At the recommended contour level, 86% of all backbone atoms, 81% of all non-hydrogen atoms, are inside the map.

## 9.5 Map-model fit summary [i](#)

The table lists the average atom inclusion at the recommended contour level (0.148) and Q-score for the entire model and for each chain.

Chain	Atom inclusion	Q-score
All	 0.8100	 0.6450
A	 0.8600	 0.6590
B	 0.8520	 0.6570
C	 0.8550	 0.6570
D	 0.5840	 0.5750
E	 0.5890	 0.5990
F	 0.5970	 0.5730
G	 0.5960	 0.6020
H	 0.5820	 0.5710
L	 0.5790	 0.6000

