



# Full wwPDB X-ray Structure Validation Report ⓘ

Oct 23, 2023 – 10:46 AM EDT

PDB ID : 3A5D  
Title : Inter-subunit interaction and quaternary rearrangement defined by the central stalk of prokaryotic V1-ATPase  
Authors : Numoto, N.; Hasegawa, Y.; Takeda, K.; Miki, K.  
Deposited on : 2009-08-06  
Resolution : 4.80 Å(reported)

This is a Full wwPDB X-ray Structure Validation Report for a publicly released PDB entry.

We welcome your comments at [validation@mail.wwpdb.org](mailto:validation@mail.wwpdb.org)

A user guide is available at

<https://www.wwpdb.org/validation/2017/XrayValidationReportHelp>

with specific help available everywhere you see the ⓘ symbol.

The types of validation reports are described at

<http://www.wwpdb.org/validation/2017/FAQs#types>.

---

The following versions of software and data (see [references ⓘ](#)) were used in the production of this report:

MolProbity : 4.02b-467  
Xtriage (Phenix) : 1.13  
EDS : 2.36  
Percentile statistics : 20191225.v01 (using entries in the PDB archive December 25th 2019)  
Refmac : 5.8.0158  
CCP4 : 7.0.044 (Gargrove)  
Ideal geometry (proteins) : Engh & Huber (2001)  
Ideal geometry (DNA, RNA) : Parkinson et al. (1996)  
Validation Pipeline (wwPDB-VP) : 2.36

# 1 Overall quality at a glance

The following experimental techniques were used to determine the structure:

*X-RAY DIFFRACTION*

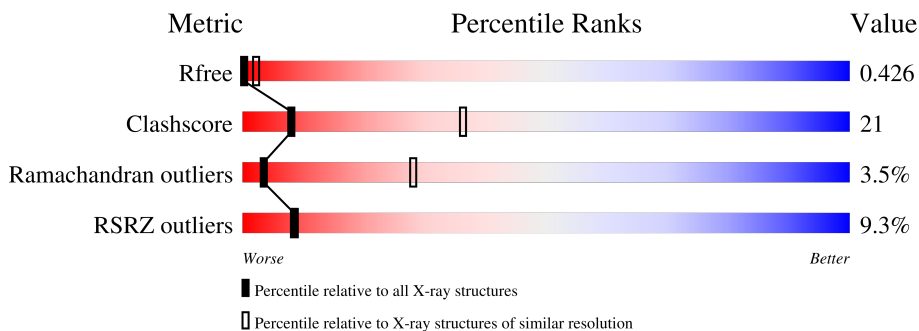

The reported resolution of this entry is 4.80 Å.

Percentile scores (ranging between 0-100) for global validation metrics of the entry are shown in the following graphic. The table shows the number of entries on which the scores are based.





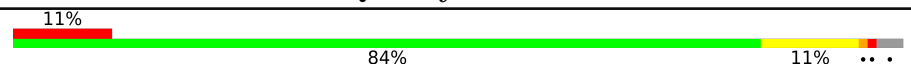
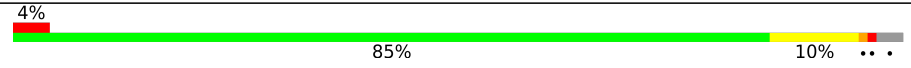
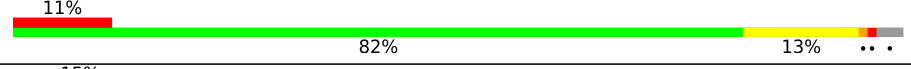
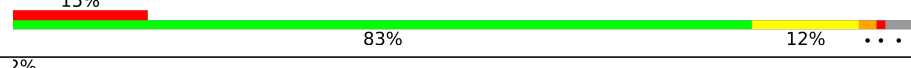

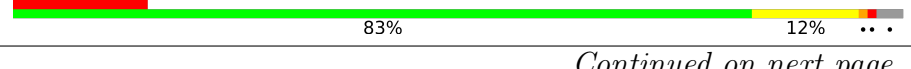

Metric	Whole archive (#Entries)	Similar resolution (#Entries, resolution range(Å))
$R_{free}$	130704	1096 (5.80-3.80)
Clashscore	141614	1170 (5.80-3.80)
Ramachandran outliers	138981	1105 (5.80-3.80)
RSRZ outliers	127900	1126 (5.90-3.70)

The table below summarises the geometric issues observed across the polymeric chains and their fit to the electron density. The red, orange, yellow and green segments of the lower bar indicate the fraction of residues that contain outliers for  $\geq 3$ , 2, 1 and 0 types of geometric quality criteria respectively. A grey segment represents the fraction of residues that are not modelled. The numeric value for each fraction is indicated below the corresponding segment, with a dot representing fractions  $\leq 5\%$ . The upper red bar (where present) indicates the fraction of residues that have poor fit to the electron density. The numeric value is given above the bar.

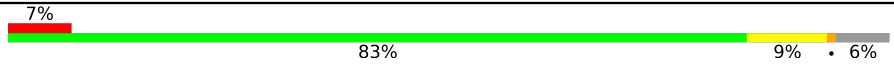
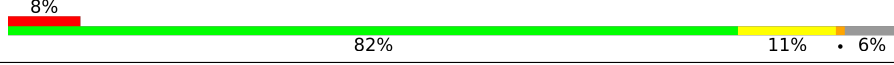
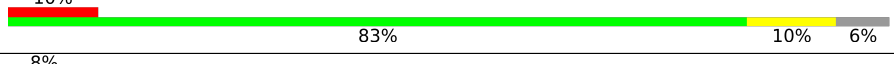
Mol	Chain	Length	Quality of chain
1	A	578	
1	B	578	
1	C	578	
1	I	578	
1	J	578	
1	K	578	

*Continued on next page...*

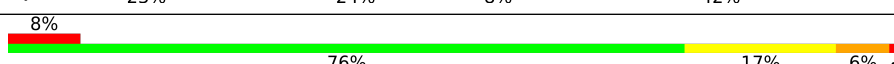
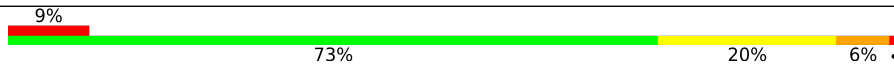
Continued from previous page...

Mol	Chain	Length	Quality of chain
2	D	478	
2	E	478	
2	F	478	
2	L	478	
2	M	478	
2	N	478	
3	G	223	
3	O	223	
4	H	104	
4	P	104	

## 2 Entry composition

There are 4 unique types of molecules in this entry. The entry contains 32080 atoms, of which 0 are hydrogens and 0 are deuteriums.

In the tables below, the ZeroOcc column contains the number of atoms modelled with zero occupancy, the AltConf column contains the number of residues with at least one atom in alternate conformation and the Trace column contains the number of residues modelled with at most 2 atoms.

- Molecule 1 is a protein called V-type ATP synthase alpha chain.

Mol	Chain	Residues	Atoms				ZeroOcc	AltConf	Trace
			Total	C	N	O			
1	A	561	2752	1630	561	561	0	0	0
1	B	561	2752	1630	561	561	0	0	0
1	C	561	2752	1630	561	561	0	0	0
1	I	561	2752	1630	561	561	0	0	0
1	J	561	2752	1630	561	561	0	0	0
1	K	561	2752	1630	561	561	0	0	0

- Molecule 2 is a protein called V-type ATP synthase beta chain.

Mol	Chain	Residues	Atoms				ZeroOcc	AltConf	Trace
			Total	C	N	O			
2	D	450	2212	1312	450	450	0	0	0
2	E	450	2212	1312	450	450	0	0	0
2	F	450	2212	1312	450	450	0	0	0
2	L	450	2212	1312	450	450	0	0	0
2	M	450	2212	1312	450	450	0	0	0
2	N	450	2212	1312	450	450	0	0	0

- Molecule 3 is a protein called V-type ATP synthase subunit D.

Mol	Chain	Residues	Atoms				ZeroOcc	AltConf	Trace
3	G	129	Total	C	N	O	0	0	0
			639	381	129	129			
3	O	129	Total	C	N	O	0	0	0
			639	381	129	129			

- Molecule 4 is a protein called V-type ATP synthase subunit F.

Mol	Chain	Residues	Atoms				ZeroOcc	AltConf	Trace
4	H	104	Total	C	N	O	0	0	0
			509	301	104	104			
4	P	104	Total	C	N	O	0	0	0
			509	301	104	104			

### 3 Residue-property plots i

These plots are drawn for all protein, RNA, DNA and oligosaccharide chains in the entry. The first graphic for a chain summarises the proportions of the various outlier classes displayed in the second graphic. The second graphic shows the sequence view annotated by issues in geometry and electron density. Residues are color-coded according to the number of geometric quality criteria for which they contain at least one outlier: green = 0, yellow = 1, orange = 2 and red = 3 or more. A red dot above a residue indicates a poor fit to the electron density ( $RSRZ > 2$ ). Stretches of 2 or more consecutive residues without any outlier are shown as a green connector. Residues present in the sample, but not in the model, are shown in grey.

- Molecule 1: V-type ATP synthase alpha chain

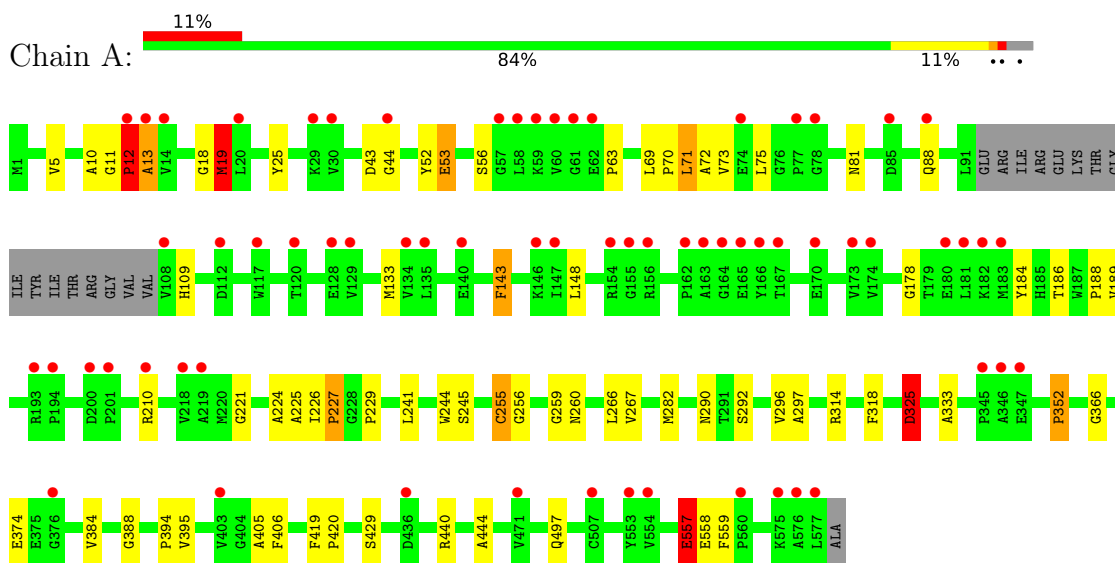

- Molecule 1: V-type ATP synthase alpha chain

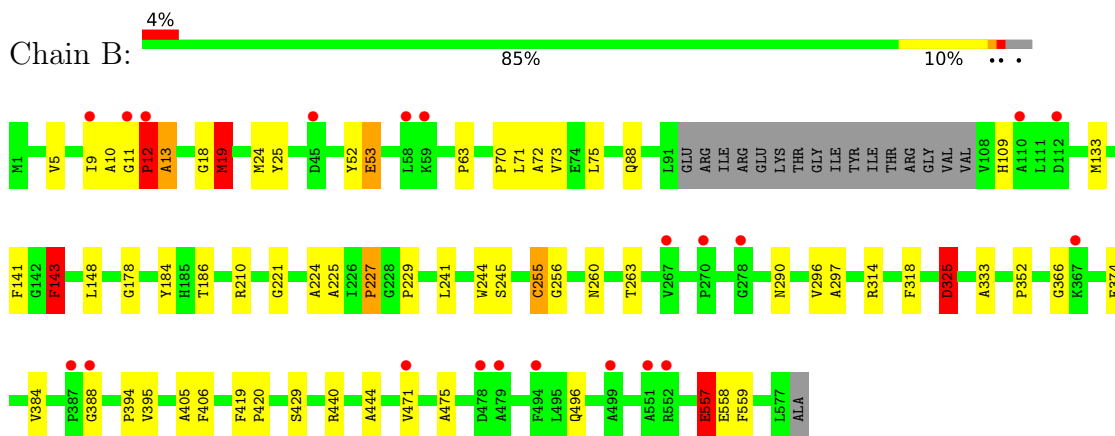

- Molecule 1: V-type ATP synthase alpha chain

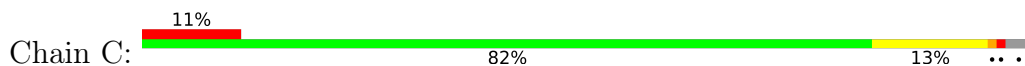

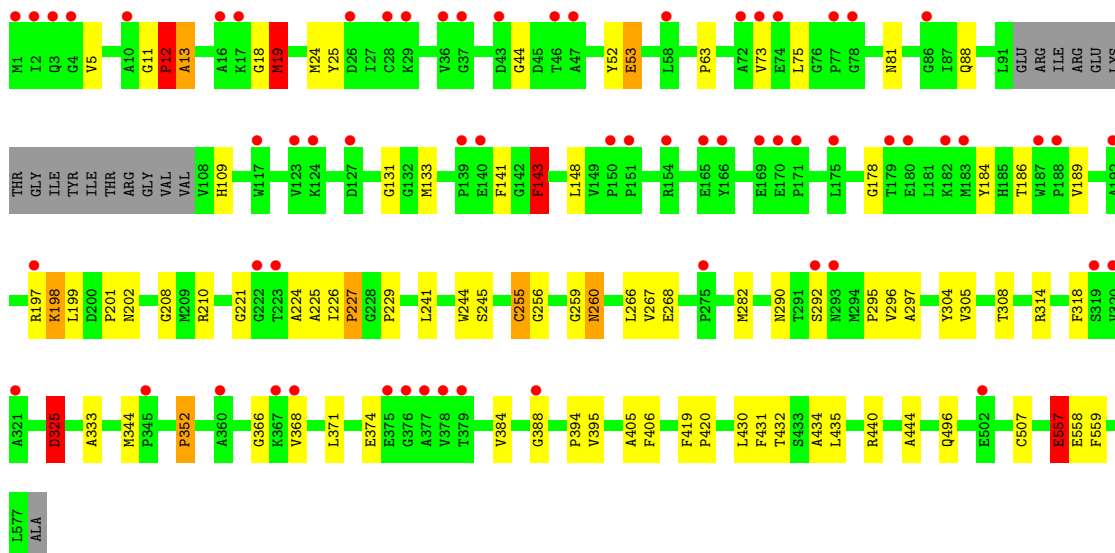

- Molecule 1: V-type ATP synthase alpha chain

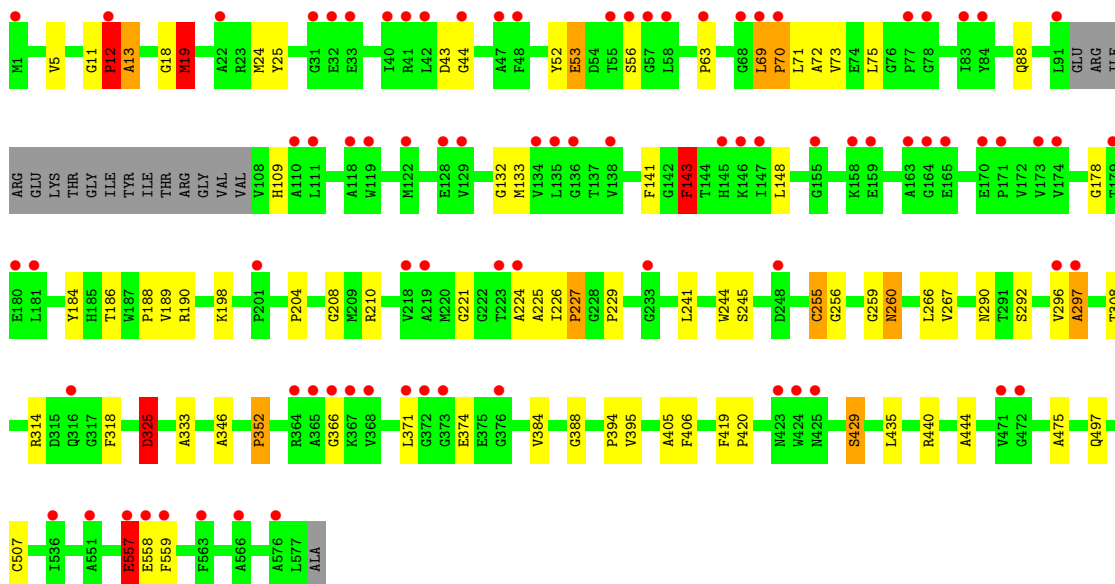
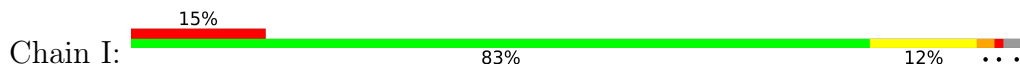

- Molecule 1: V-type ATP synthase alpha chain

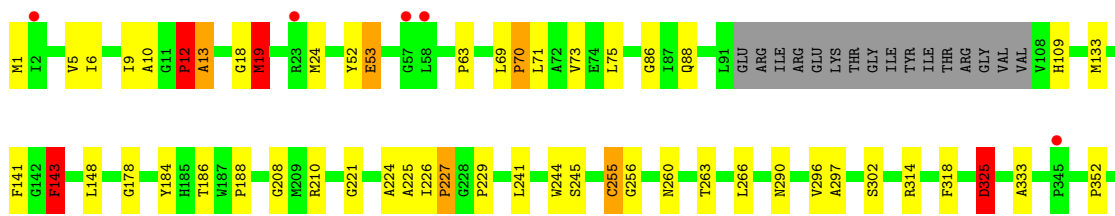
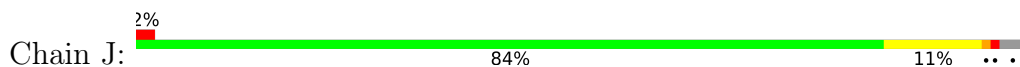



• Molecule 1: V-type ATP synthase alpha chain

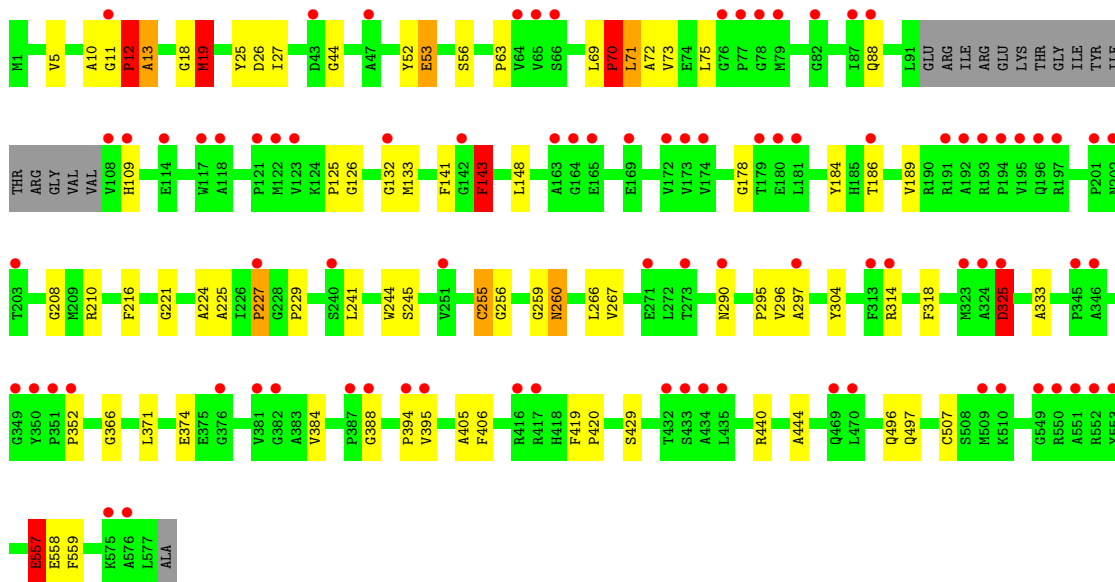
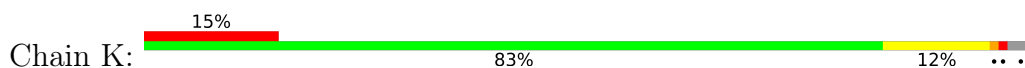

• Molecule 2: V-type ATP synthase beta chain

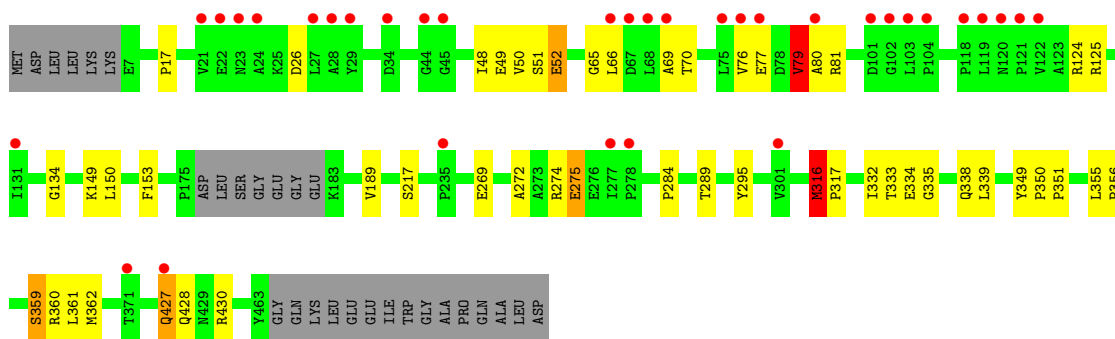
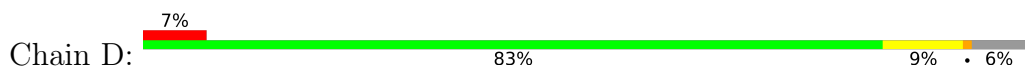

• Molecule 2: V-type ATP synthase beta chain

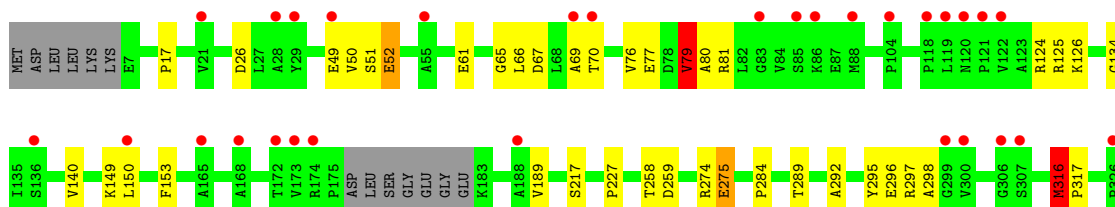
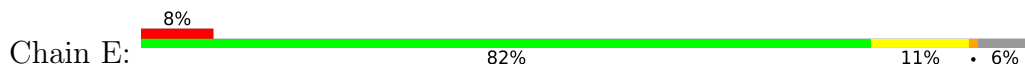



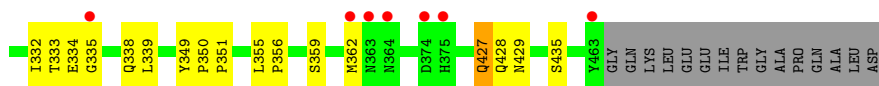

- Molecule 2: V-type ATP synthase beta chain

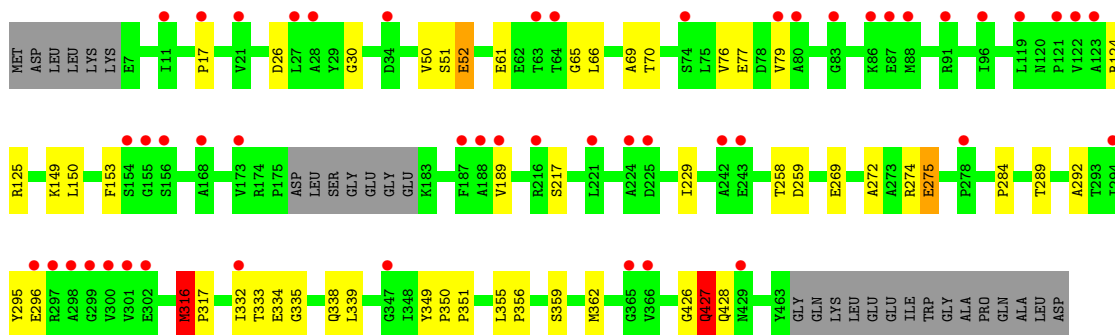
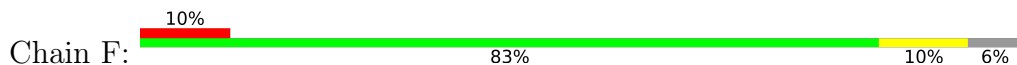

- Molecule 2: V-type ATP synthase beta chain

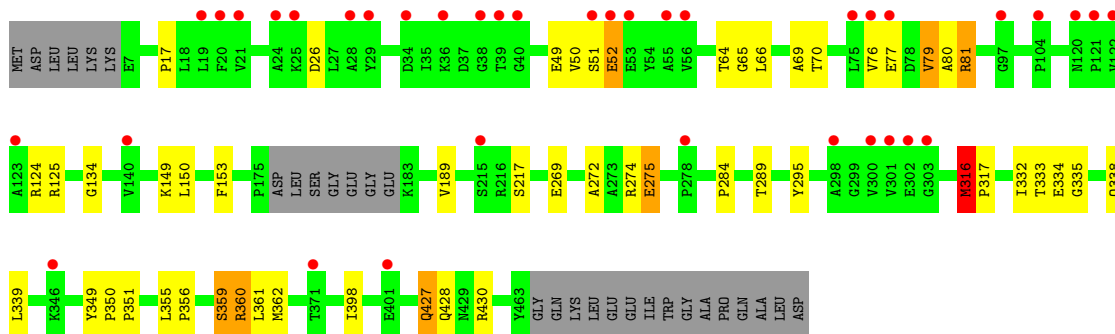
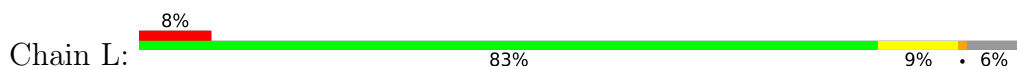

- Molecule 2: V-type ATP synthase beta chain

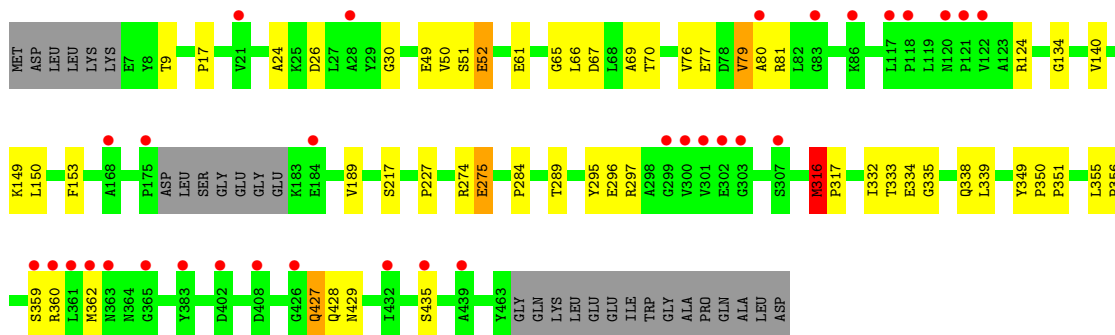
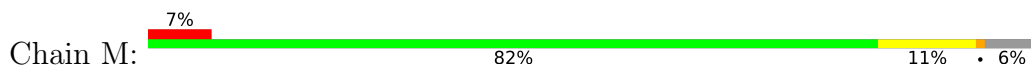

- Molecule 2: V-type ATP synthase beta chain

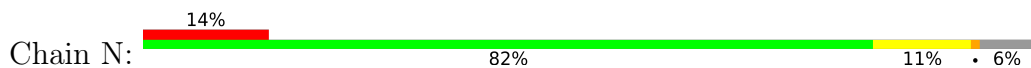

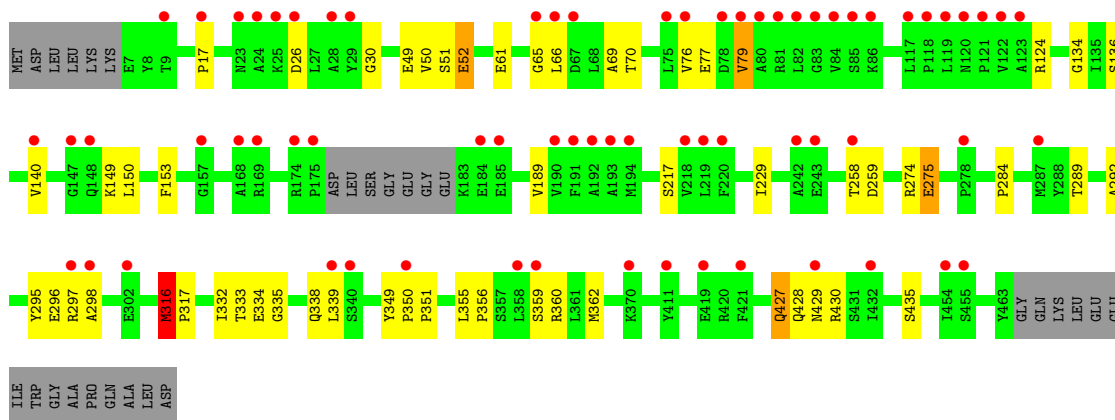

• Molecule 3: V-type ATP synthase subunit D

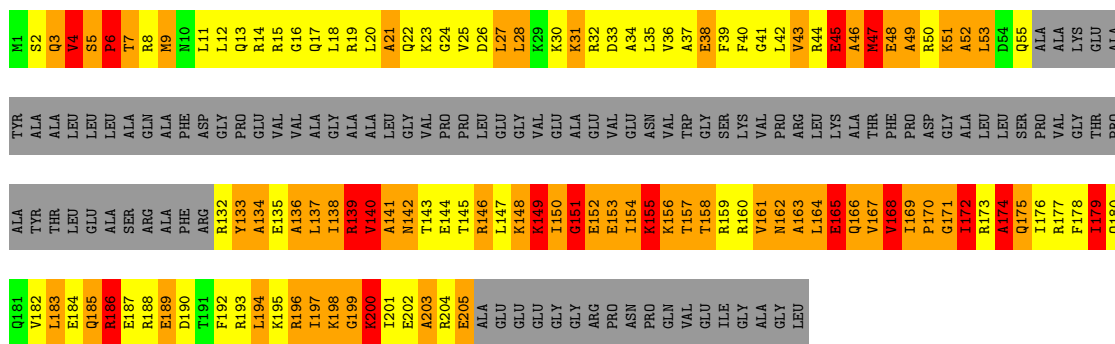
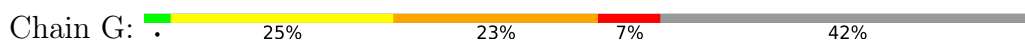

• Molecule 3: V-type ATP synthase subunit D

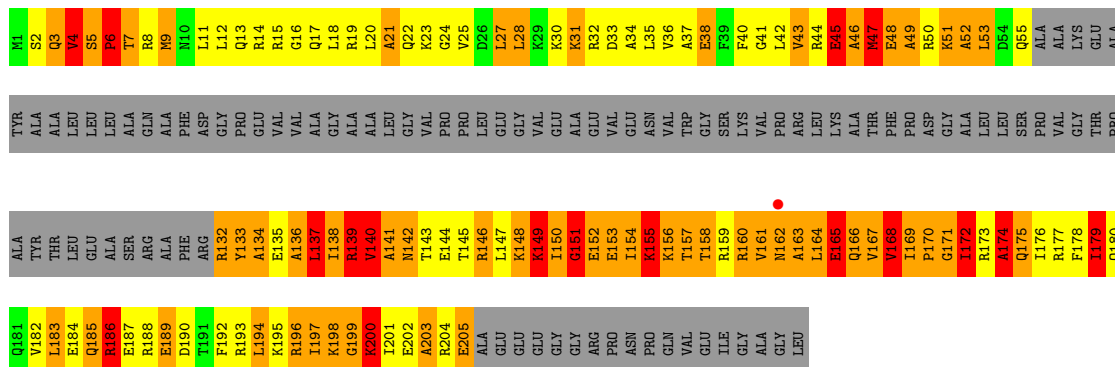
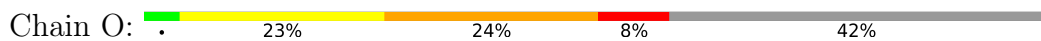

• Molecule 4: V-type ATP synthase subunit F

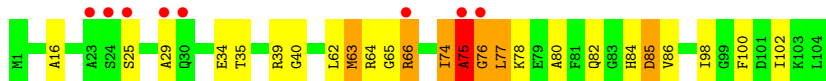
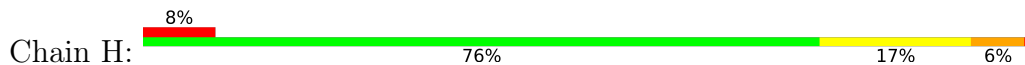

• Molecule 4: V-type ATP synthase subunit F

Chain P:  9% 73% 20% 6%

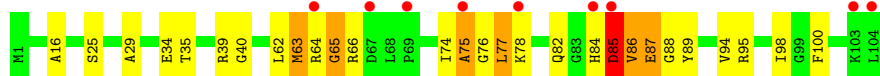

## 4 Data and refinement statistics

Property	Value	Source
Space group	P 3 2 1	Depositor
Cell constants a, b, c, $\alpha$ , $\beta$ , $\gamma$	380.70Å 380.70Å 147.97Å 90.00° 90.00° 120.00°	Depositor
Resolution (Å)	29.97 – 4.80 49.72 – 4.80	Depositor EDS
% Data completeness (in resolution range)	95.3 (29.97-4.80) 95.2 (49.72-4.80)	Depositor EDS
$R_{merge}$	(Not available)	Depositor
$R_{sym}$	0.07	Depositor
$\langle I/\sigma(I) \rangle$ <sup>1</sup>	2.01 (at 4.86Å)	Xtrriage
Refinement program	CNS 1.2	Depositor
R, $R_{free}$	0.441 , 0.454 0.413 , 0.426	Depositor DCC
$R_{free}$ test set	2935 reflections (5.12%)	wwPDB-VP
Wilson B-factor (Å <sup>2</sup> )	173.9	Xtrriage
Anisotropy	0.068	Xtrriage
Bulk solvent $k_{sol}$ (e/Å <sup>3</sup> ), $B_{sol}$ (Å <sup>2</sup> )	0.13 , 999.0	EDS
L-test for twinning <sup>2</sup>	$\langle  L  \rangle = 0.28$ , $\langle L^2 \rangle = 0.12$	Xtrriage
Estimated twinning fraction	0.217 for -h,-k,l	Xtrriage
$F_o, F_c$ correlation	0.71	EDS
Total number of atoms	32080	wwPDB-VP
Average B, all atoms (Å <sup>2</sup> )	191.0	wwPDB-VP

Xtrriage's analysis on translational NCS is as follows: *The largest off-origin peak in the Patterson function is 1.54% of the height of the origin peak. No significant pseudotranslation is detected.*

<sup>1</sup>Intensities estimated from amplitudes.

<sup>2</sup>Theoretical values of  $\langle |L| \rangle$ ,  $\langle L^2 \rangle$  for acentric reflections are 0.5, 0.333 respectively for untwinned datasets, and 0.375, 0.2 for perfectly twinned datasets.

## 5 Model quality i

### 5.1 Standard geometry i

The Z score for a bond length (or angle) is the number of standard deviations the observed value is removed from the expected value. A bond length (or angle) with  $|Z| > 5$  is considered an outlier worth inspection. RMSZ is the root-mean-square of all Z scores of the bond lengths (or angles).

Mol	Chain	Bond lengths		Bond angles	
		RMSZ	# Z  >5	RMSZ	# Z  >5
1	A	0.59	3/2750 (0.1%)	1.25	12/3815 (0.3%)
1	B	0.62	4/2750 (0.1%)	1.19	9/3815 (0.2%)
1	C	0.60	4/2750 (0.1%)	1.20	10/3815 (0.3%)
1	I	0.61	4/2750 (0.1%)	1.30	17/3815 (0.4%)
1	J	0.61	4/2750 (0.1%)	1.26	13/3815 (0.3%)
1	K	0.61	4/2750 (0.1%)	1.43	12/3815 (0.3%)
2	D	0.77	6/2210 (0.3%)	1.02	11/3068 (0.4%)
2	E	0.77	6/2210 (0.3%)	1.01	9/3068 (0.3%)
2	F	0.73	3/2210 (0.1%)	0.99	7/3068 (0.2%)
2	L	0.79	6/2210 (0.3%)	1.07	14/3068 (0.5%)
2	M	0.76	5/2210 (0.2%)	1.00	8/3068 (0.3%)
2	N	0.75	3/2210 (0.1%)	1.00	7/3068 (0.2%)
3	G	4.09	125/637 (19.6%)	2.63	49/885 (5.5%)
3	O	4.09	125/637 (19.6%)	2.63	50/885 (5.6%)
4	H	1.50	9/508 (1.8%)	1.43	10/703 (1.4%)
4	P	1.61	10/508 (2.0%)	2.13	17/703 (2.4%)
All	All	1.08	321/32050 (1.0%)	1.28	255/44474 (0.6%)

Chiral center outliers are detected by calculating the chiral volume of a chiral center and verifying if the center is modelled as a planar moiety or with the opposite hand. A planarity outlier is detected by checking planarity of atoms in a peptide group, atoms in a mainchain group or atoms of a sidechain that are expected to be planar.

Mol	Chain	#Chirality outliers	#Planarity outliers
1	A	0	5
1	B	0	5
1	C	0	6
1	I	0	6
1	J	0	6
1	K	0	6
2	D	0	3
2	E	0	3
2	F	0	2

*Continued on next page...*

*Continued from previous page...*

Mol	Chain	#Chirality outliers	#Planarity outliers
2	L	0	3
2	M	0	3
2	N	0	3
4	H	0	2
4	P	0	2
All	All	0	55

All (321) bond length outliers are listed below:

Mol	Chain	Res	Type	Atoms	Z	Observed(Å)	Ideal(Å)
3	O	47	MET	CA-CB	-24.95	0.99	1.53
3	G	47	MET	CA-CB	-24.94	0.99	1.53
3	O	27	LEU	CA-CB	14.84	1.87	1.53
3	G	27	LEU	CA-CB	14.76	1.87	1.53
3	O	7	THR	CA-CB	12.80	1.86	1.53
3	G	7	THR	CA-CB	12.65	1.86	1.53
3	O	31	LYS	N-CA	12.38	1.71	1.46
3	G	31	LYS	N-CA	12.13	1.70	1.46
3	G	138	ILE	CA-CB	-12.12	1.26	1.54
3	G	196	ARG	CA-C	12.09	1.84	1.52
3	O	138	ILE	CA-CB	-12.07	1.27	1.54
3	O	196	ARG	CA-C	12.05	1.84	1.52
3	O	52	ALA	CA-CB	11.20	1.75	1.52
3	O	205	GLU	CA-CB	11.19	1.78	1.53
3	G	52	ALA	CA-CB	11.13	1.75	1.52
3	G	168	VAL	CA-CB	-11.09	1.31	1.54
3	G	16	GLY	CA-C	11.09	1.69	1.51
3	O	16	GLY	CA-C	11.07	1.69	1.51
3	G	205	GLU	CA-CB	10.99	1.78	1.53
3	O	168	VAL	CA-CB	-10.98	1.31	1.54
3	G	167	VAL	CA-C	10.89	1.81	1.52
3	O	167	VAL	CA-C	10.86	1.81	1.52
4	P	34	GLU	C-O	10.60	1.43	1.23
4	H	34	GLU	C-O	10.58	1.43	1.23
3	O	171	GLY	CA-C	10.55	1.68	1.51
3	G	171	GLY	CA-C	10.49	1.68	1.51
3	G	189	GLU	CA-CB	10.25	1.76	1.53
3	O	16	GLY	C-O	10.25	1.40	1.23
3	O	189	GLU	CA-CB	10.19	1.76	1.53
3	G	16	GLY	C-O	10.00	1.39	1.23
3	O	4	VAL	CA-C	9.78	1.78	1.52
3	G	4	VAL	CA-C	9.75	1.78	1.52

*Continued on next page...*

*Continued from previous page...*

Mol	Chain	Res	Type	Atoms	Z	Observed(Å)	Ideal(Å)
3	O	19	ARG	N-CA	9.49	1.65	1.46
3	G	19	ARG	N-CA	9.48	1.65	1.46
3	O	50	ARG	C-O	9.29	1.41	1.23
3	O	32	ARG	C-O	9.14	1.40	1.23
3	G	32	ARG	C-O	9.12	1.40	1.23
3	G	50	ARG	C-O	9.11	1.40	1.23
3	G	164	LEU	C-O	9.09	1.40	1.23
3	O	164	LEU	C-O	9.08	1.40	1.23
3	G	184	GLU	CA-CB	9.05	1.73	1.53
3	O	184	GLU	CA-CB	9.04	1.73	1.53
3	O	163	ALA	C-O	8.96	1.40	1.23
3	G	184	GLU	N-CA	8.95	1.64	1.46
3	G	6	PRO	C-O	8.94	1.41	1.23
3	O	184	GLU	N-CA	8.92	1.64	1.46
3	G	163	ALA	C-O	8.85	1.40	1.23
3	O	169	ILE	C-O	8.76	1.40	1.23
3	G	169	ILE	C-O	8.71	1.39	1.23
1	B	429	SER	C-N	8.70	1.54	1.34
3	O	6	PRO	C-O	8.68	1.40	1.23
3	O	142	ASN	CA-CB	8.66	1.75	1.53
3	G	183	LEU	C-O	8.60	1.39	1.23
3	G	142	ASN	CA-CB	8.60	1.75	1.53
3	G	194	LEU	CA-C	8.55	1.75	1.52
3	O	183	LEU	C-O	8.52	1.39	1.23
3	O	194	LEU	CA-C	8.46	1.75	1.52
3	G	163	ALA	CA-C	8.43	1.74	1.52
3	O	38	GLU	N-CA	8.40	1.63	1.46
3	O	163	ALA	CA-C	8.35	1.74	1.52
3	G	38	GLU	N-CA	8.32	1.62	1.46
3	G	182	VAL	N-CA	8.28	1.62	1.46
3	O	182	VAL	N-CA	8.27	1.62	1.46
4	P	40	GLY	C-O	8.20	1.36	1.23
4	H	40	GLY	C-O	8.10	1.36	1.23
4	P	75	ALA	N-CA	8.05	1.62	1.46
3	O	34	ALA	CA-CB	-8.04	1.35	1.52
3	G	34	ALA	CA-CB	-8.02	1.35	1.52
3	O	155	LYS	N-CA	8.01	1.62	1.46
3	G	155	LYS	N-CA	7.99	1.62	1.46
3	G	195	LYS	N-CA	7.96	1.62	1.46
3	O	205	GLU	CA-C	7.88	1.73	1.52
3	O	185	GLN	C-O	7.88	1.38	1.23
3	O	170	PRO	CA-C	7.87	1.68	1.52

*Continued on next page...*

*Continued from previous page...*

Mol	Chain	Res	Type	Atoms	Z	Observed(Å)	Ideal(Å)
3	O	195	LYS	N-CA	7.87	1.62	1.46
3	G	185	GLN	C-O	7.84	1.38	1.23
3	G	205	GLU	CA-C	7.82	1.73	1.52
3	G	170	PRO	CA-C	7.73	1.68	1.52
3	O	198	LYS	C-O	7.73	1.38	1.23
3	G	198	LYS	C-O	7.71	1.38	1.23
3	G	24	GLY	CA-C	7.67	1.64	1.51
3	G	46	ALA	C-O	7.62	1.37	1.23
3	G	192	PHE	C-O	7.56	1.37	1.23
3	O	46	ALA	C-O	7.56	1.37	1.23
3	O	24	GLY	CA-C	7.55	1.64	1.51
3	O	192	PHE	C-O	7.54	1.37	1.23
1	J	429	SER	C-N	7.47	1.51	1.34
3	O	51	LYS	C-O	7.46	1.37	1.23
3	G	134	ALA	CA-CB	7.46	1.68	1.52
3	O	4	VAL	CA-CB	7.44	1.70	1.54
3	G	4	VAL	CA-CB	7.42	1.70	1.54
1	K	70	PRO	C-N	7.42	1.51	1.34
3	G	33	ASP	N-CA	7.40	1.61	1.46
2	L	81	ARG	CA-C	7.40	1.72	1.52
3	O	33	ASP	N-CA	7.40	1.61	1.46
4	P	76	GLY	N-CA	7.37	1.57	1.46
3	G	51	LYS	C-O	7.37	1.37	1.23
3	O	134	ALA	CA-CB	7.37	1.68	1.52
3	O	134	ALA	N-CA	7.34	1.61	1.46
3	G	134	ALA	N-CA	7.32	1.60	1.46
3	G	167	VAL	CA-CB	7.31	1.70	1.54
3	O	146	ARG	CA-CB	7.31	1.70	1.53
4	P	75	ALA	CA-C	7.30	1.72	1.52
3	G	6	PRO	CA-CB	7.29	1.68	1.53
3	G	22	GLN	C-O	7.29	1.37	1.23
3	O	53	LEU	N-CA	7.28	1.60	1.46
3	G	146	ARG	CA-CB	7.26	1.70	1.53
2	L	81	ARG	N-CA	7.26	1.60	1.46
3	O	22	GLN	C-O	7.23	1.37	1.23
3	O	20	LEU	CA-C	7.22	1.71	1.52
3	G	20	LEU	CA-C	7.21	1.71	1.52
4	P	76	GLY	CA-C	7.20	1.63	1.51
3	O	167	VAL	CA-CB	7.18	1.69	1.54
3	O	6	PRO	CA-CB	7.16	1.67	1.53
3	G	193	ARG	N-CA	7.12	1.60	1.46
3	O	172	ILE	N-CA	7.11	1.60	1.46

*Continued on next page...*



*Continued from previous page...*

Mol	Chain	Res	Type	Atoms	Z	Observed(Å)	Ideal(Å)
3	G	172	ILE	N-CA	7.09	1.60	1.46
3	O	193	ARG	N-CA	7.09	1.60	1.46
3	O	27	LEU	N-CA	7.07	1.60	1.46
3	G	53	LEU	N-CA	7.07	1.60	1.46
3	G	188	ARG	N-CA	7.05	1.60	1.46
3	G	27	LEU	N-CA	7.05	1.60	1.46
3	G	154	ILE	C-O	7.05	1.36	1.23
3	O	188	ARG	N-CA	7.04	1.60	1.46
3	O	52	ALA	N-CA	6.99	1.60	1.46
2	L	80	ALA	CA-C	6.99	1.71	1.52
3	G	199	GLY	N-CA	6.96	1.56	1.46
3	G	179	ILE	C-O	6.96	1.36	1.23
4	P	77	LEU	N-CA	6.95	1.60	1.46
2	D	81	ARG	N-CA	6.95	1.60	1.46
3	G	4	VAL	C-O	6.95	1.36	1.23
3	G	52	ALA	N-CA	6.94	1.60	1.46
3	O	11	LEU	CA-CB	6.93	1.69	1.53
3	G	32	ARG	CA-C	6.92	1.71	1.52
3	G	156	LYS	CA-C	6.91	1.71	1.52
3	G	11	LEU	CA-CB	6.91	1.69	1.53
3	O	179	ILE	C-O	6.90	1.36	1.23
3	O	32	ARG	CA-C	6.89	1.70	1.52
3	O	156	LYS	CA-C	6.87	1.70	1.52
3	O	4	VAL	C-O	6.86	1.36	1.23
3	O	154	ILE	C-O	6.82	1.36	1.23
3	O	199	GLY	N-CA	6.71	1.56	1.46
2	E	81	ARG	N-CA	6.66	1.59	1.46
3	O	169	ILE	N-CA	6.63	1.59	1.46
3	G	204	ARG	N-CA	6.61	1.59	1.46
3	O	175	GLN	CA-CB	-6.60	1.39	1.53
3	G	5	SER	CA-CB	6.59	1.62	1.52
3	O	204	ARG	N-CA	6.57	1.59	1.46
3	G	17	GLN	CA-CB	-6.55	1.39	1.53
3	O	32	ARG	C-N	6.52	1.49	1.34
3	G	169	ILE	N-CA	6.51	1.59	1.46
3	G	189	GLU	CA-C	6.50	1.69	1.52
3	G	175	GLN	CA-CB	-6.48	1.39	1.53
3	O	148	LYS	CA-CB	6.48	1.68	1.53
3	O	17	GLN	CA-CB	-6.48	1.39	1.53
3	G	32	ARG	C-N	6.47	1.49	1.34
3	G	148	LYS	CA-CB	6.46	1.68	1.53
3	O	189	GLU	CA-C	6.44	1.69	1.52

*Continued on next page...*

*Continued from previous page...*

Mol	Chain	Res	Type	Atoms	Z	Observed(Å)	Ideal(Å)
3	G	14	ARG	N-CA	6.41	1.59	1.46
3	O	5	SER	CA-CB	6.39	1.62	1.52
3	O	9	MET	CA-C	-6.37	1.36	1.52
3	O	196	ARG	CA-CB	6.36	1.68	1.53
3	G	14	ARG	C-O	6.36	1.35	1.23
3	G	28	LEU	CA-C	6.35	1.69	1.52
3	O	31	LYS	C-O	6.33	1.35	1.23
3	G	196	ARG	CA-CB	6.32	1.67	1.53
3	G	9	MET	CA-C	-6.29	1.36	1.52
3	O	14	ARG	C-O	6.29	1.35	1.23
4	H	40	GLY	C-N	6.25	1.44	1.33
2	D	80	ALA	CA-C	6.21	1.69	1.52
3	O	14	ARG	N-CA	6.20	1.58	1.46
3	O	28	LEU	CA-C	6.19	1.69	1.52
3	O	192	PHE	CA-C	6.19	1.69	1.52
3	G	31	LYS	C-O	6.18	1.35	1.23
4	P	40	GLY	C-N	6.18	1.44	1.33
3	O	45	GLU	C-O	6.13	1.34	1.23
4	H	75	ALA	N-CA	6.13	1.58	1.46
3	O	24	GLY	C-O	6.13	1.33	1.23
3	G	192	PHE	CA-C	6.12	1.68	1.52
1	K	13	ALA	CA-CB	-6.09	1.39	1.52
1	J	13	ALA	CA-CB	-6.09	1.39	1.52
1	B	13	ALA	CA-CB	-6.08	1.39	1.52
3	G	164	LEU	N-CA	6.08	1.58	1.46
3	O	164	LEU	N-CA	6.06	1.58	1.46
3	O	194	LEU	C-O	6.05	1.34	1.23
3	O	201	ILE	CA-CB	-6.05	1.41	1.54
1	C	13	ALA	CA-CB	-6.05	1.39	1.52
1	A	13	ALA	CA-CB	-6.02	1.39	1.52
3	G	194	LEU	C-O	6.01	1.34	1.23
3	O	203	ALA	N-CA	-6.00	1.34	1.46
3	G	45	GLU	C-O	5.99	1.34	1.23
3	G	205	GLU	C-O	5.98	1.34	1.23
3	G	201	ILE	CA-CB	-5.98	1.41	1.54
3	O	205	GLU	C-O	5.98	1.34	1.23
1	I	13	ALA	CA-CB	-5.98	1.39	1.52
3	G	7	THR	CA-C	5.96	1.68	1.52
3	G	166	GLN	CA-CB	-5.96	1.40	1.53
3	O	7	THR	CA-C	5.95	1.68	1.52
2	E	80	ALA	CA-C	5.94	1.68	1.52
3	O	166	GLN	CA-CB	-5.92	1.41	1.53

*Continued on next page...*

*Continued from previous page...*

Mol	Chain	Res	Type	Atoms	Z	Observed(Å)	Ideal(Å)
3	G	24	GLY	C-O	5.85	1.33	1.23
3	G	203	ALA	N-CA	-5.83	1.34	1.46
3	G	21	ALA	C-O	5.81	1.34	1.23
3	G	37	ALA	CA-CB	-5.81	1.40	1.52
3	O	14	ARG	CA-CB	5.79	1.66	1.53
3	G	23	LYS	N-CA	5.73	1.57	1.46
3	O	141	ALA	CA-CB	5.73	1.64	1.52
2	M	81	ARG	N-CA	5.72	1.57	1.46
2	D	81	ARG	CA-C	5.72	1.67	1.52
3	O	23	LYS	N-CA	5.70	1.57	1.46
3	G	170	PRO	N-CA	5.69	1.56	1.47
3	O	21	ALA	C-O	5.69	1.34	1.23
3	O	52	ALA	C-O	5.69	1.34	1.23
2	N	275	GLU	CA-CB	-5.68	1.41	1.53
3	G	52	ALA	C-O	5.68	1.34	1.23
3	G	49	ALA	N-CA	5.67	1.57	1.46
3	O	37	ALA	CA-CB	-5.66	1.40	1.52
2	L	275	GLU	CA-CB	-5.64	1.41	1.53
2	M	275	GLU	CA-CB	-5.63	1.41	1.53
3	G	49	ALA	CA-CB	-5.62	1.40	1.52
4	H	25	SER	CA-CB	5.61	1.61	1.52
3	O	47	MET	C-O	5.60	1.33	1.23
2	E	275	GLU	CA-CB	-5.59	1.41	1.53
3	G	141	ALA	CA-CB	5.59	1.64	1.52
3	O	170	PRO	N-CA	5.58	1.56	1.47
3	G	14	ARG	CA-CB	5.58	1.66	1.53
3	O	171	GLY	C-O	5.58	1.32	1.23
3	G	158	THR	CA-CB	-5.57	1.38	1.53
3	G	25	VAL	N-CA	5.57	1.57	1.46
3	G	47	MET	C-O	5.57	1.33	1.23
2	F	275	GLU	CA-CB	-5.57	1.41	1.53
3	O	25	VAL	N-CA	5.57	1.57	1.46
3	G	148	LYS	N-CA	5.56	1.57	1.46
3	G	15	ARG	CA-CB	5.54	1.66	1.53
2	D	275	GLU	CA-CB	-5.54	1.41	1.53
2	L	289	THR	C-N	5.53	1.46	1.34
3	O	15	ARG	CA-CB	5.53	1.66	1.53
3	O	158	THR	CA-CB	-5.52	1.39	1.53
2	E	81	ARG	CA-C	5.52	1.67	1.52
3	O	49	ALA	N-CA	5.52	1.57	1.46
4	H	75	ALA	CA-C	5.51	1.67	1.52
3	O	148	LYS	N-CA	5.50	1.57	1.46

*Continued on next page...*

*Continued from previous page...*

Mol	Chain	Res	Type	Atoms	Z	Observed(Å)	Ideal(Å)
3	G	171	GLY	C-O	5.50	1.32	1.23
4	P	25	SER	CA-CB	5.49	1.61	1.52
3	O	187	GLU	CA-C	5.48	1.67	1.52
3	O	49	ALA	CA-CB	-5.45	1.41	1.52
3	G	36	VAL	CA-C	5.45	1.67	1.52
3	G	163	ALA	C-N	5.44	1.46	1.34
3	G	187	GLU	CA-C	5.44	1.67	1.52
3	O	163	ALA	C-N	5.43	1.46	1.34
3	O	7	THR	C-O	5.42	1.33	1.23
2	E	316	MET	C-N	-5.41	1.24	1.34
3	G	7	THR	C-O	5.40	1.33	1.23
2	L	316	MET	C-N	-5.39	1.24	1.34
3	O	36	VAL	CA-C	5.39	1.67	1.52
1	K	19	MET	CA-CB	-5.38	1.42	1.53
2	N	316	MET	C-N	-5.38	1.24	1.34
1	I	19	MET	CA-CB	-5.37	1.42	1.53
4	H	76	GLY	N-CA	5.36	1.54	1.46
1	A	19	MET	CA-CB	-5.36	1.42	1.53
1	J	19	MET	CA-CB	-5.36	1.42	1.53
1	B	19	MET	CA-CB	-5.36	1.42	1.53
1	C	19	MET	CA-CB	-5.35	1.42	1.53
2	M	289	THR	C-N	5.34	1.46	1.34
3	O	28	LEU	C-O	5.34	1.33	1.23
2	D	289	THR	C-N	5.34	1.46	1.34
2	N	289	THR	C-N	5.34	1.46	1.34
1	I	352	PRO	CA-CB	-5.30	1.43	1.53
2	F	316	MET	C-N	-5.29	1.24	1.34
1	J	352	PRO	CA-CB	-5.29	1.43	1.53
2	E	289	THR	C-N	5.29	1.46	1.34
2	F	289	THR	C-N	5.29	1.46	1.34
2	M	316	MET	C-N	-5.29	1.24	1.34
3	G	15	ARG	C-O	5.28	1.33	1.23
3	O	7	THR	N-CA	5.25	1.56	1.46
1	A	352	PRO	CA-CB	-5.25	1.43	1.53
3	G	28	LEU	C-O	5.24	1.33	1.23
1	K	352	PRO	CA-CB	-5.24	1.43	1.53
1	B	352	PRO	CA-CB	-5.23	1.43	1.53
3	O	138	ILE	CA-C	-5.23	1.39	1.52
3	O	196	ARG	C-O	5.22	1.33	1.23
4	P	29	ALA	CA-CB	-5.22	1.41	1.52
3	G	7	THR	N-CA	5.22	1.56	1.46
3	O	49	ALA	CA-C	-5.20	1.39	1.52

*Continued on next page...*

Continued from previous page...

Mol	Chain	Res	Type	Atoms	Z	Observed(Å)	Ideal(Å)
3	G	143	THR	N-CA	5.20	1.56	1.46
3	O	153	GLU	N-CA	5.18	1.56	1.46
3	G	162	ASN	C-O	5.18	1.33	1.23
4	H	29	ALA	CA-CB	-5.18	1.41	1.52
3	G	153	GLU	N-CA	5.17	1.56	1.46
3	G	200	LYS	CA-C	5.17	1.66	1.52
3	G	49	ALA	CA-C	-5.16	1.39	1.52
3	G	201	ILE	C-O	5.16	1.33	1.23
2	D	316	MET	C-N	-5.16	1.24	1.34
3	G	196	ARG	C-O	5.15	1.33	1.23
3	O	165	GLU	C-O	5.15	1.33	1.23
3	G	37	ALA	C-O	5.15	1.33	1.23
3	O	15	ARG	C-O	5.14	1.33	1.23
3	G	36	VAL	C-O	5.14	1.33	1.23
3	G	139	ARG	CA-CB	5.12	1.65	1.53
3	O	162	ASN	C-O	5.12	1.33	1.23
3	O	201	ILE	C-O	5.12	1.33	1.23
3	O	143	THR	N-CA	5.11	1.56	1.46
4	H	76	GLY	CA-C	5.10	1.60	1.51
3	O	200	LYS	CA-C	5.10	1.66	1.52
3	G	22	GLN	C-N	5.10	1.45	1.34
3	G	165	GLU	C-O	5.10	1.33	1.23
3	O	36	VAL	CA-CB	5.09	1.65	1.54
1	C	198	LYS	C-N	5.09	1.45	1.34
1	I	70	PRO	CA-C	5.08	1.63	1.52
1	C	352	PRO	CA-CB	-5.08	1.43	1.53
3	O	36	VAL	C-O	5.08	1.32	1.23
3	O	165	GLU	N-CA	5.07	1.56	1.46
3	O	160	ARG	C-O	5.06	1.32	1.23
3	O	22	GLN	C-N	5.06	1.45	1.34
3	G	138	ILE	CA-C	-5.05	1.39	1.52
3	O	37	ALA	C-O	5.05	1.32	1.23
3	O	132	ARG	C-O	5.04	1.32	1.23
3	G	36	VAL	CA-CB	5.03	1.65	1.54
3	G	50	ARG	CA-C	5.01	1.66	1.52
2	M	80	ALA	CA-C	5.01	1.66	1.52
3	G	26	ASP	C-O	5.00	1.32	1.23

All (255) bond angle outliers are listed below:

Mol	Chain	Res	Type	Atoms	Z	Observed(°)	Ideal(°)
1	I	325	ASP	O-C-N	-39.90	58.87	122.70

Continued on next page...

*Continued from previous page...*

Mol	Chain	Res	Type	Atoms	Z	Observed(°)	Ideal(°)
1	J	325	ASP	O-C-N	-39.90	58.87	122.70
1	A	325	ASP	O-C-N	-39.88	58.90	122.70
1	C	325	ASP	O-C-N	-39.88	58.90	122.70
1	B	325	ASP	O-C-N	-39.85	58.94	122.70
1	K	325	ASP	O-C-N	-39.85	58.94	122.70
1	K	70	PRO	C-N-CA	-33.48	37.99	121.70
1	K	70	PRO	CA-C-N	-26.39	59.13	117.20
4	P	85	ASP	CA-C-N	-23.16	66.25	117.20
1	K	70	PRO	O-C-N	22.93	159.40	122.70
1	J	429	SER	O-C-N	-19.52	91.47	122.70
4	P	85	ASP	O-C-N	19.35	153.66	122.70
1	C	325	ASP	C-N-CA	-18.31	75.92	121.70
1	A	325	ASP	C-N-CA	-18.28	76.01	121.70
1	K	325	ASP	C-N-CA	-18.25	76.08	121.70
1	B	325	ASP	C-N-CA	-18.22	76.14	121.70
1	J	325	ASP	C-N-CA	-18.22	76.16	121.70
1	I	325	ASP	C-N-CA	-18.18	76.25	121.70
1	A	429	SER	O-C-N	-17.37	94.90	122.70
4	P	77	LEU	C-N-CA	-15.81	82.18	121.70
2	D	316	MET	O-C-N	-15.67	91.32	121.10
2	L	316	MET	O-C-N	-15.63	91.40	121.10
2	E	316	MET	O-C-N	-15.61	91.45	121.10
2	F	316	MET	O-C-N	-15.57	91.52	121.10
4	P	85	ASP	CA-C-O	-15.57	87.40	120.10
2	N	316	MET	O-C-N	-15.55	91.55	121.10
2	M	316	MET	O-C-N	-15.55	91.56	121.10
1	I	325	ASP	CA-C-N	15.10	150.43	117.20
1	B	325	ASP	CA-C-N	15.08	150.38	117.20
1	J	325	ASP	CA-C-N	15.07	150.36	117.20
1	A	325	ASP	CA-C-N	15.00	150.20	117.20
1	C	325	ASP	CA-C-N	15.00	150.20	117.20
1	K	325	ASP	CA-C-N	14.98	150.16	117.20
1	I	429	SER	CA-C-N	-14.05	86.30	117.20
4	H	77	LEU	C-N-CA	-13.83	87.13	121.70
4	P	74	ILE	O-C-N	-13.23	101.54	122.70
1	I	429	SER	O-C-N	12.86	143.27	122.70
1	I	198	LYS	O-C-N	12.68	143.00	122.70
1	A	429	SER	CA-C-N	12.13	143.89	117.20
1	J	429	SER	CA-C-N	11.33	142.12	117.20
1	I	198	LYS	CA-C-N	-10.96	93.09	117.20
1	I	429	SER	C-N-CA	-10.82	94.66	121.70
3	O	47	MET	N-CA-C	10.64	139.72	111.00

*Continued on next page...*

*Continued from previous page...*

Mol	Chain	Res	Type	Atoms	Z	Observed(°)	Ideal(°)
3	G	47	MET	N-CA-C	10.62	139.69	111.00
2	L	80	ALA	C-N-CA	10.52	148.01	121.70
3	O	139	ARG	N-CA-C	-10.46	82.76	111.00
3	G	139	ARG	N-CA-C	-10.45	82.79	111.00
1	A	429	SER	C-N-CA	10.08	146.89	121.70
4	P	76	GLY	C-N-CA	10.04	146.80	121.70
3	O	6	PRO	C-N-CA	-9.82	97.16	121.70
3	G	6	PRO	C-N-CA	-9.73	97.36	121.70
3	G	6	PRO	N-CA-CB	9.71	114.95	103.30
4	P	77	LEU	CA-C-N	9.67	138.48	117.20
2	D	316	MET	CA-C-N	9.47	143.63	117.10
2	L	316	MET	CA-C-N	9.46	143.58	117.10
2	N	316	MET	CA-C-N	9.46	143.58	117.10
2	E	316	MET	CA-C-N	9.45	143.57	117.10
2	F	316	MET	CA-C-N	9.45	143.55	117.10
2	M	316	MET	CA-C-N	9.44	143.52	117.10
3	O	6	PRO	N-CA-CB	9.41	114.60	103.30
2	L	80	ALA	CA-C-N	9.41	137.90	117.20
3	O	9	MET	C-N-CA	-9.37	98.29	121.70
3	G	9	MET	C-N-CA	-9.36	98.29	121.70
3	O	49	ALA	C-N-CA	-9.15	98.83	121.70
3	G	49	ALA	C-N-CA	-9.12	98.91	121.70
4	P	76	GLY	CA-C-N	8.87	136.72	117.20
1	I	70	PRO	N-CA-C	-8.86	89.06	112.10
4	P	74	ILE	CA-C-N	8.81	136.57	117.20
1	I	63	PRO	N-CA-CB	8.73	113.77	103.30
1	K	63	PRO	N-CA-CB	8.68	113.71	103.30
1	C	63	PRO	N-CA-CB	8.67	113.70	103.30
3	O	47	MET	C-N-CA	-8.57	100.28	121.70
1	B	63	PRO	N-CA-CB	8.57	113.58	103.30
3	G	47	MET	C-N-CA	-8.56	100.30	121.70
1	J	63	PRO	N-CA-CB	8.55	113.56	103.30
4	H	77	LEU	CA-C-N	8.54	135.99	117.20
1	A	63	PRO	N-CA-CB	8.53	113.54	103.30
4	P	75	ALA	N-CA-C	8.52	134.01	111.00
3	G	187	GLU	N-CA-C	8.43	133.75	111.00
3	O	187	GLU	N-CA-C	8.35	133.53	111.00
4	H	74	ILE	O-C-N	-8.32	109.38	122.70
3	O	31	LYS	CA-C-N	-8.28	98.98	117.20
3	G	31	LYS	CA-C-N	-8.28	98.98	117.20
1	J	429	SER	C-N-CA	8.24	142.31	121.70
1	I	198	LYS	C-N-CA	-8.11	101.42	121.70

*Continued on next page...*

*Continued from previous page...*

Mol	Chain	Res	Type	Atoms	Z	Observed(°)	Ideal(°)
4	H	76	GLY	C-N-CA	8.06	141.86	121.70
3	O	186	ARG	C-N-CA	-7.87	102.03	121.70
3	O	203	ALA	N-CA-C	-7.81	89.92	111.00
3	G	203	ALA	N-CA-C	-7.79	89.96	111.00
3	G	186	ARG	C-N-CA	-7.65	102.58	121.70
3	G	167	VAL	O-C-N	-7.49	110.71	122.70
3	O	167	VAL	O-C-N	-7.47	110.75	122.70
3	O	31	LYS	O-C-N	7.34	134.45	122.70
3	G	31	LYS	O-C-N	7.29	134.37	122.70
3	O	167	VAL	C-N-CA	-7.28	103.51	121.70
3	G	167	VAL	C-N-CA	-7.26	103.55	121.70
2	L	289	THR	O-C-N	-7.25	111.11	122.70
2	D	289	THR	O-C-N	-7.20	111.17	122.70
3	G	7	THR	C-N-CA	-7.19	103.72	121.70
2	E	289	THR	O-C-N	-7.17	111.23	122.70
2	N	289	THR	O-C-N	-7.16	111.25	122.70
2	M	289	THR	O-C-N	-7.15	111.26	122.70
4	P	76	GLY	CA-C-O	-7.14	107.74	120.60
3	O	7	THR	C-N-CA	-7.13	103.86	121.70
3	G	153	GLU	N-CA-C	7.08	130.13	111.00
3	O	30	LYS	C-N-CA	7.08	139.41	121.70
2	F	289	THR	O-C-N	-7.08	111.37	122.70
3	O	133	TYR	N-CA-C	-7.08	91.89	111.00
3	G	30	LYS	C-N-CA	7.08	139.39	121.70
3	O	170	PRO	N-CA-CB	7.07	111.79	103.30
3	G	133	TYR	N-CA-C	-7.06	91.94	111.00
3	G	170	PRO	N-CA-CB	7.04	111.75	103.30
3	O	153	GLU	N-CA-C	7.02	129.96	111.00
4	H	76	GLY	CA-C-N	7.01	132.63	117.20
3	O	157	THR	N-CA-C	-7.00	92.09	111.00
3	G	157	THR	N-CA-C	-6.99	92.12	111.00
3	O	182	VAL	O-C-N	6.97	133.85	122.70
3	G	202	GLU	CA-C-N	-6.96	101.89	117.20
3	O	202	GLU	CA-C-N	-6.92	101.98	117.20
3	G	156	LYS	N-CA-C	6.90	129.63	111.00
3	O	156	LYS	N-CA-C	6.90	129.63	111.00
3	G	151	GLY	N-CA-C	-6.88	95.90	113.10
4	H	75	ALA	N-CA-C	6.86	129.51	111.00
3	O	151	GLY	N-CA-C	-6.84	96.00	113.10
3	G	182	VAL	O-C-N	6.81	133.60	122.70
4	P	65	GLY	N-CA-C	-6.76	96.20	113.10
1	C	12	PRO	N-CA-CB	6.75	111.39	103.30

*Continued on next page...*



*Continued from previous page...*

Mol	Chain	Res	Type	Atoms	Z	Observed(°)	Ideal(°)
3	G	167	VAL	CA-C-N	6.74	132.03	117.20
2	L	360	ARG	N-CA-C	-6.73	92.83	111.00
3	G	12	LEU	N-CA-C	-6.70	92.91	111.00
3	O	167	VAL	CA-C-N	6.69	131.92	117.20
1	K	12	PRO	N-CA-CB	6.67	111.31	103.30
3	O	12	LEU	N-CA-C	-6.64	93.07	111.00
1	B	12	PRO	N-CA-CB	6.62	111.24	103.30
1	A	12	PRO	N-CA-CB	6.61	111.23	103.30
1	J	12	PRO	N-CA-CB	6.60	111.22	103.30
2	L	81	ARG	CA-C-N	6.59	131.70	117.20
1	I	12	PRO	N-CA-CB	6.58	111.20	103.30
3	G	49	ALA	CA-C-N	-6.53	102.83	117.20
3	O	49	ALA	CA-C-N	-6.50	102.89	117.20
3	G	154	ILE	N-CA-C	-6.47	93.52	111.00
3	G	156	LYS	C-N-CA	-6.47	105.53	121.70
2	D	289	THR	CA-C-N	6.46	131.42	117.20
2	E	289	THR	CA-C-N	6.46	131.41	117.20
3	O	156	LYS	C-N-CA	-6.45	105.58	121.70
1	I	143	PHE	N-CA-C	6.44	128.38	111.00
2	L	359	SER	N-CA-C	-6.43	93.63	111.00
3	O	154	ILE	N-CA-C	-6.43	93.63	111.00
3	G	196	ARG	CB-CA-C	6.43	123.26	110.40
2	L	289	THR	CA-C-N	6.42	131.33	117.20
2	N	289	THR	CA-C-N	6.42	131.32	117.20
3	O	196	ARG	N-CA-CB	-6.41	99.06	110.60
3	G	196	ARG	N-CA-CB	-6.39	99.09	110.60
1	C	229	PRO	N-CA-CB	6.39	110.97	103.30
1	C	143	PHE	N-CA-C	6.38	128.22	111.00
1	J	143	PHE	N-CA-C	6.38	128.22	111.00
1	K	143	PHE	N-CA-C	6.38	128.22	111.00
2	M	289	THR	CA-C-N	6.37	131.22	117.20
3	O	196	ARG	CB-CA-C	6.37	123.14	110.40
1	B	143	PHE	N-CA-C	6.37	128.20	111.00
1	C	198	LYS	O-C-N	-6.36	112.53	122.70
1	I	69	LEU	O-C-N	6.35	133.16	121.10
4	P	77	LEU	O-C-N	-6.34	112.55	122.70
1	I	229	PRO	N-CA-CB	6.34	110.91	103.30
2	F	289	THR	CA-C-N	6.33	131.14	117.20
1	A	143	PHE	N-CA-C	6.28	127.94	111.00
1	B	229	PRO	N-CA-CB	6.28	110.83	103.30
1	J	229	PRO	N-CA-CB	6.27	110.82	103.30
3	G	199	GLY	N-CA-C	-6.26	97.45	113.10

*Continued on next page...*

*Continued from previous page...*

Mol	Chain	Res	Type	Atoms	Z	Observed(°)	Ideal(°)
3	O	199	GLY	N-CA-C	-6.25	97.48	113.10
4	P	64	ARG	N-CA-C	-6.24	94.14	111.00
1	K	229	PRO	N-CA-CB	6.23	110.78	103.30
2	D	359	SER	N-CA-C	-6.22	94.19	111.00
2	L	80	ALA	O-C-N	-6.21	112.76	122.70
1	J	70	PRO	N-CA-C	-6.13	96.16	112.10
3	O	21	ALA	O-C-N	6.11	132.48	122.70
1	A	229	PRO	N-CA-CB	6.09	110.61	103.30
3	G	21	ALA	O-C-N	6.05	132.37	122.70
2	F	17	PRO	N-CA-CB	6.01	110.51	103.30
2	E	17	PRO	N-CA-CB	5.98	110.48	103.30
2	D	17	PRO	N-CA-CB	5.97	110.47	103.30
3	G	194	LEU	N-CA-C	5.96	127.09	111.00
3	O	194	LEU	N-CA-C	5.94	127.03	111.00
2	E	81	ARG	N-CA-C	5.93	127.00	111.00
2	D	284	PRO	N-CA-CB	5.92	110.41	103.30
3	O	149	LYS	N-CA-C	-5.92	95.03	111.00
2	L	284	PRO	N-CA-CB	5.91	110.39	103.30
2	N	284	PRO	N-CA-CB	5.91	110.39	103.30
2	N	351	PRO	N-CA-CB	5.91	110.39	103.30
2	L	17	PRO	N-CA-CB	5.90	110.38	103.30
2	D	81	ARG	N-CA-C	5.88	126.88	111.00
2	N	17	PRO	N-CA-CB	5.88	110.36	103.30
3	G	149	LYS	N-CA-C	-5.88	95.13	111.00
2	M	351	PRO	N-CA-CB	5.87	110.34	103.30
2	M	17	PRO	N-CA-CB	5.87	110.34	103.30
3	G	188	ARG	N-CA-CB	5.86	121.14	110.60
2	E	284	PRO	N-CA-CB	5.85	110.32	103.30
2	D	351	PRO	N-CA-CB	5.83	110.30	103.30
2	M	81	ARG	N-CA-C	5.82	126.72	111.00
2	M	284	PRO	N-CA-CB	5.80	110.26	103.30
1	J	557	GLU	O-C-N	-5.80	113.42	122.70
2	F	284	PRO	N-CA-CB	5.80	110.26	103.30
2	L	351	PRO	N-CA-CB	5.79	110.25	103.30
3	O	21	ALA	CB-CA-C	-5.77	101.44	110.10
3	O	136	ALA	N-CA-C	-5.76	95.45	111.00
1	C	557	GLU	O-C-N	-5.76	113.49	122.70
1	B	557	GLU	O-C-N	-5.75	113.51	122.70
3	G	21	ALA	CB-CA-C	-5.74	101.48	110.10
2	E	351	PRO	N-CA-CB	5.74	110.18	103.30
3	O	188	ARG	N-CA-CB	5.73	120.92	110.60
1	K	557	GLU	O-C-N	-5.71	113.57	122.70

*Continued on next page...*

*Continued from previous page...*

Mol	Chain	Res	Type	Atoms	Z	Observed(°)	Ideal(°)
2	F	351	PRO	N-CA-CB	5.71	110.15	103.30
1	I	557	GLU	O-C-N	-5.70	113.58	122.70
1	A	557	GLU	O-C-N	-5.70	113.59	122.70
3	G	142	ASN	N-CA-C	-5.67	95.69	111.00
3	O	47	MET	N-CA-CB	-5.66	100.41	110.60
3	G	47	MET	N-CA-CB	-5.65	100.42	110.60
3	G	136	ALA	N-CA-C	-5.65	95.74	111.00
1	C	244	TRP	N-CA-C	5.64	126.24	111.00
4	H	76	GLY	CA-C-O	-5.64	110.46	120.60
1	B	244	TRP	N-CA-C	5.62	126.18	111.00
4	H	77	LEU	O-C-N	-5.62	113.71	122.70
3	O	142	ASN	N-CA-C	-5.60	95.89	111.00
1	K	244	TRP	N-CA-C	5.53	125.94	111.00
1	J	244	TRP	N-CA-C	5.53	125.93	111.00
1	I	244	TRP	N-CA-C	5.51	125.88	111.00
4	H	74	ILE	CA-C-N	5.48	129.26	117.20
3	G	47	MET	CA-C-O	5.46	131.57	120.10
2	D	360	ARG	N-CA-C	-5.46	96.27	111.00
3	G	174	ALA	C-N-CA	-5.42	108.14	121.70
4	P	35	THR	CB-CA-C	-5.41	96.99	111.60
4	H	35	THR	CB-CA-C	-5.40	97.01	111.60
3	O	47	MET	CA-C-O	5.38	131.40	120.10
3	O	155	LYS	C-N-CA	-5.37	108.28	121.70
3	O	174	ALA	C-N-CA	-5.36	108.31	121.70
3	O	140	VAL	N-CA-C	5.35	125.45	111.00
4	P	75	ALA	C-N-CA	5.35	133.54	122.30
3	G	155	LYS	C-N-CA	-5.32	108.39	121.70
3	G	140	VAL	N-CA-C	5.32	125.37	111.00
4	P	77	LEU	CA-C-O	-5.31	108.95	120.10
1	A	70	PRO	N-CA-C	-5.30	98.31	112.10
3	O	171	GLY	N-CA-C	-5.21	100.06	113.10
3	G	31	LYS	CB-CA-C	-5.21	99.98	110.40
3	O	31	LYS	CB-CA-C	-5.18	100.05	110.40
2	L	80	ALA	CA-C-O	-5.14	109.30	120.10
3	G	171	GLY	N-CA-C	-5.13	100.27	113.10
3	O	137	LEU	O-C-N	-5.11	114.52	122.70
3	O	156	LYS	CA-C-N	5.09	128.40	117.20
3	G	156	LYS	CA-C-N	5.08	128.37	117.20
2	E	79	VAL	O-C-N	-5.08	114.58	122.70
2	D	79	VAL	CA-C-N	-5.06	106.06	117.20
3	O	21	ALA	CA-C-N	-5.05	106.08	117.20
3	G	21	ALA	CA-C-N	-5.03	106.13	117.20

*Continued on next page...*

*Continued from previous page...*

Mol	Chain	Res	Type	Atoms	Z	Observed(°)	Ideal(°)
3	O	47	MET	CB-CA-C	-5.01	100.38	110.40
3	G	47	MET	CB-CA-C	-5.01	100.39	110.40

There are no chirality outliers.

All (55) planarity outliers are listed below:

Mol	Chain	Res	Type	Group
1	A	178	GLY	Peptide
1	A	210	ARG	Mainchain
1	A	297	ALA	Mainchain
1	A	325	ASP	Mainchain
1	A	557	GLU	Mainchain
1	B	178	GLY	Peptide
1	B	210	ARG	Mainchain
1	B	297	ALA	Mainchain
1	B	325	ASP	Mainchain
1	B	557	GLU	Mainchain
1	C	178	GLY	Peptide
1	C	198	LYS	Mainchain
1	C	210	ARG	Mainchain
1	C	297	ALA	Mainchain
1	C	325	ASP	Mainchain
1	C	557	GLU	Mainchain
2	D	316	MET	Mainchain
2	D	427	GLN	Peptide
2	D	79	VAL	Mainchain
2	E	316	MET	Mainchain
2	E	427	GLN	Peptide
2	E	79	VAL	Mainchain
2	F	316	MET	Mainchain
2	F	427	GLN	Peptide
4	H	39	ARG	Peptide
4	H	82	GLN	Peptide
1	I	178	GLY	Peptide
1	I	210	ARG	Mainchain
1	I	297	ALA	Mainchain
1	I	325	ASP	Mainchain
1	I	429	SER	Mainchain
1	I	557	GLU	Mainchain
1	J	178	GLY	Peptide
1	J	210	ARG	Mainchain
1	J	297	ALA	Mainchain

*Continued on next page...*

*Continued from previous page...*

Mol	Chain	Res	Type	Group
1	J	325	ASP	Mainchain
1	J	429	SER	Mainchain
1	J	557	GLU	Mainchain
1	K	178	GLY	Peptide
1	K	210	ARG	Mainchain
1	K	297	ALA	Mainchain
1	K	325	ASP	Mainchain
1	K	557	GLU	Mainchain
1	K	70	PRO	Mainchain
2	L	316	MET	Mainchain
2	L	427	GLN	Peptide
2	L	79	VAL	Mainchain
2	M	316	MET	Mainchain
2	M	427	GLN	Peptide
2	M	79	VAL	Mainchain
2	N	316	MET	Mainchain
2	N	427	GLN	Peptide
2	N	79	VAL	Mainchain
4	P	39	ARG	Peptide
4	P	82	GLN	Peptide

## 5.2 Too-close contacts

In the following table, the Non-H and H(model) columns list the number of non-hydrogen atoms and hydrogen atoms in the chain respectively. The H(added) column lists the number of hydrogen atoms added and optimized by MolProbity. The Clashes column lists the number of clashes within the asymmetric unit, whereas Symm-Clashes lists symmetry-related clashes.

Mol	Chain	Non-H	H(model)	H(added)	Clashes	Symm-Clashes
1	A	2752	0	1302	87	0
1	B	2752	0	1303	71	0
1	C	2752	0	1303	98	0
1	I	2752	0	1301	134	0
1	J	2752	0	1303	52	3
1	K	2752	0	1303	91	0
2	D	2212	0	1009	73	0
2	E	2212	0	1009	56	0
2	F	2212	0	1009	78	0
2	L	2212	0	1009	94	0
2	M	2212	0	1009	50	3
2	N	2212	0	1009	78	0
3	G	639	0	299	133	0

*Continued on next page...*

*Continued from previous page...*

Mol	Chain	Non-H	H(model)	H(added)	Clashes	Symm-Clashes
3	O	639	0	299	135	0
4	H	509	0	255	22	0
4	P	509	0	254	18	0
All	All	32080	0	14976	1006	3

The all-atom clashscore is defined as the number of clashes found per 1000 atoms (including hydrogen atoms). The all-atom clashscore for this structure is 21.

All (1006) close contacts within the same asymmetric unit are listed below, sorted by their clash magnitude.

Atom-1	Atom-2	Interatomic distance (Å)	Clash overlap (Å)
3:O:142:ASN:CB	3:O:142:ASN:CA	1.75	1.64
3:O:189:GLU:CB	3:O:189:GLU:CA	1.76	1.64
3:G:205:GLU:CB	3:G:205:GLU:CA	1.78	1.62
1:K:52:TYR:CA	1:K:295:PRO:CB	1.79	1.59
3:O:52:ALA:CB	3:O:52:ALA:CA	1.76	1.59
1:B:24:MET:CB	2:E:66:LEU:CA	1.74	1.58
3:G:189:GLU:CA	3:G:189:GLU:CB	1.76	1.57
3:O:205:GLU:CA	3:O:205:GLU:CB	1.78	1.57
1:B:471:VAL:CB	4:H:98:ILE:CB	1.79	1.57
3:G:52:ALA:CB	3:G:52:ALA:CA	1.75	1.57
2:D:359:SER:CB	2:D:362:MET:CB	1.78	1.56
3:O:163:ALA:C	3:O:163:ALA:CA	1.74	1.55
3:G:163:ALA:C	3:G:163:ALA:CA	1.74	1.55
3:G:142:ASN:CB	3:G:142:ASN:CA	1.75	1.54
1:I:71:LEU:CB	1:I:188:PRO:HA	1.31	1.54
1:C:52:TYR:HA	1:C:295:PRO:CB	1.16	1.54
2:N:140:VAL:CB	2:N:435:SER:CB	1.76	1.54
3:G:7:THR:CB	3:G:7:THR:CA	1.86	1.54
3:O:31:LYS:N	3:O:31:LYS:CA	1.71	1.54
1:C:52:TYR:CA	1:C:295:PRO:CB	1.85	1.53
1:I:43:ASP:C	2:L:69:ALA:CB	1.76	1.53
3:G:194:LEU:C	3:G:194:LEU:CA	1.75	1.52
1:A:71:LEU:CB	1:A:188:PRO:HA	1.35	1.52
3:O:27:LEU:CB	3:O:27:LEU:CA	1.87	1.51
3:O:194:LEU:C	3:O:194:LEU:CA	1.74	1.51
3:G:31:LYS:N	3:G:31:LYS:CA	1.70	1.51
3:O:4:VAL:C	3:O:4:VAL:CA	1.78	1.51
3:O:7:THR:CA	3:O:7:THR:CB	1.86	1.51
3:G:27:LEU:CA	3:G:27:LEU:CB	1.87	1.50
1:C:352:PRO:CB	2:F:269:GLU:HA	1.41	1.50

*Continued on next page...*

*Continued from previous page...*

Atom-1	Atom-2	Interatomic distance (Å)	Clash overlap (Å)
3:G:167:VAL:C	3:G:167:VAL:CA	1.81	1.49
3:G:4:VAL:C	3:G:4:VAL:CA	1.78	1.49
3:O:167:VAL:C	3:O:167:VAL:CA	1.81	1.49
1:I:44:GLY:N	2:L:69:ALA:CB	1.70	1.48
1:I:25:TYR:N	2:L:66:LEU:H	1.12	1.47
3:O:196:ARG:CA	3:O:196:ARG:C	1.84	1.46
1:B:24:MET:CB	2:E:66:LEU:HA	0.97	1.44
3:G:196:ARG:C	3:G:196:ARG:CA	1.84	1.42
4:H:65:GLY:HA3	4:H:66:ARG:CB	1.16	1.41
1:B:9:ILE:CB	2:D:50:VAL:O	1.66	1.40
2:L:359:SER:CB	2:L:362:MET:CB	1.97	1.39
1:I:43:ASP:C	2:L:69:ALA:HB2	1.33	1.38
1:C:25:TYR:CB	2:F:65:GLY:HA2	1.55	1.37
1:I:25:TYR:H	2:L:66:LEU:N	1.23	1.37
3:G:44:ARG:O	3:G:47:MET:CB	1.71	1.36
4:H:65:GLY:CA	4:H:66:ARG:CB	2.04	1.35
1:A:11:GLY:HA3	2:F:50:VAL:O	1.17	1.34
1:C:419:PHE:O	1:C:496:GLN:CA	1.73	1.34
3:O:44:ARG:O	3:O:47:MET:CB	1.72	1.34
1:K:52:TYR:HA	1:K:295:PRO:CB	0.87	1.34
1:I:11:GLY:CA	2:N:50:VAL:H	1.42	1.33
1:J:9:ILE:CB	2:L:50:VAL:O	1.78	1.32
1:C:419:PHE:O	1:C:496:GLN:HA	1.25	1.30
1:C:52:TYR:CB	1:C:295:PRO:CB	2.10	1.29
1:I:266:LEU:C	2:N:124:ARG:CB	1.99	1.29
1:K:259:GLY:O	2:M:296:GLU:C	1.67	1.29
1:K:419:PHE:O	1:K:496:GLN:CA	1.79	1.28
1:I:267:VAL:N	2:N:124:ARG:CB	1.98	1.27
1:K:44:GLY:HA2	2:N:69:ALA:CB	1.63	1.27
1:I:44:GLY:CA	2:L:69:ALA:CB	2.12	1.26
1:I:11:GLY:HA3	2:N:50:VAL:C	1.55	1.26
1:I:224:ALA:CB	1:I:405:ALA:HB3	1.65	1.25
1:C:224:ALA:CB	1:C:405:ALA:HB3	1.65	1.25
1:I:24:MET:HA	2:L:66:LEU:CA	1.65	1.25
1:J:224:ALA:CB	1:J:405:ALA:HB3	1.65	1.24
1:B:224:ALA:CB	1:B:405:ALA:HB3	1.65	1.24
1:K:69:LEU:CB	1:K:72:ALA:HB3	1.66	1.24
1:A:224:ALA:CB	1:A:405:ALA:HB3	1.65	1.24
1:K:224:ALA:CB	1:K:405:ALA:HB3	1.66	1.23
2:M:140:VAL:CB	2:M:435:SER:CB	2.16	1.23
1:K:419:PHE:O	1:K:497:GLN:N	1.70	1.22

*Continued on next page...*

*Continued from previous page...*

Atom-1	Atom-2	Interatomic distance (Å)	Clash overlap (Å)
4:H:84:HIS:O	4:H:86:VAL:N	1.72	1.22
1:I:71:LEU:CB	1:I:188:PRO:CA	2.18	1.22
1:C:419:PHE:O	1:C:496:GLN:CB	1.86	1.21
1:I:11:GLY:CA	2:N:50:VAL:N	2.03	1.20
1:I:44:GLY:CA	2:L:69:ALA:HB1	1.68	1.20
1:I:11:GLY:HA3	2:N:50:VAL:O	1.40	1.20
1:K:419:PHE:O	1:K:496:GLN:HA	1.12	1.19
2:F:426:GLY:O	1:K:125:PRO:C	1.80	1.18
1:I:11:GLY:HA3	2:N:50:VAL:CA	1.72	1.17
1:I:43:ASP:C	2:L:69:ALA:HB3	1.66	1.16
1:B:10:ALA:O	2:D:50:VAL:N	1.77	1.16
1:C:352:PRO:CB	2:F:269:GLU:CA	2.23	1.16
1:B:11:GLY:HA3	2:D:49:GLU:CB	1.75	1.15
1:B:263:THR:CB	2:D:125:ARG:N	2.10	1.15
1:I:266:LEU:CB	2:N:124:ARG:CB	2.25	1.14
1:A:71:LEU:CB	1:A:188:PRO:CA	2.25	1.14
1:B:10:ALA:H	2:D:50:VAL:CB	1.60	1.12
1:A:10:ALA:O	2:F:50:VAL:CB	1.98	1.12
1:I:44:GLY:N	2:L:69:ALA:HB1	1.43	1.11
1:C:25:TYR:H	2:F:66:LEU:N	1.48	1.11
1:K:44:GLY:HA2	2:N:69:ALA:HB3	1.25	1.11
1:A:44:GLY:HA2	2:D:69:ALA:CB	1.80	1.10
1:A:266:LEU:CB	2:F:124:ARG:CB	2.29	1.10
1:I:11:GLY:HA3	2:N:50:VAL:N	1.65	1.10
1:I:44:GLY:HA2	2:L:69:ALA:CB	1.78	1.10
1:C:189:VAL:CB	1:C:305:VAL:HA	1.81	1.10
1:C:25:TYR:N	2:F:66:LEU:H	1.49	1.09
1:I:43:ASP:O	2:L:69:ALA:HB3	1.49	1.09
1:I:24:MET:CA	2:L:66:LEU:HA	1.81	1.09
1:C:44:GLY:HA2	2:F:69:ALA:CB	1.83	1.08
2:M:359:SER:CB	2:M:362:MET:CB	2.31	1.08
4:H:62:LEU:O	4:H:63:MET:O	1.69	1.08
1:B:25:TYR:O	2:E:65:GLY:HA2	1.53	1.07
4:P:75:ALA:HB2	4:P:85:ASP:O	1.54	1.07
1:A:44:GLY:HA2	2:D:69:ALA:HB3	1.32	1.07
2:D:149:LYS:O	2:D:334:GLU:N	1.87	1.07
2:F:149:LYS:O	2:F:334:GLU:N	1.87	1.06
3:O:176:ILE:O	3:O:179:ILE:CB	2.03	1.06
3:G:176:ILE:O	3:G:179:ILE:CB	2.03	1.06
2:N:149:LYS:O	2:N:334:GLU:N	1.87	1.06
2:L:149:LYS:O	2:L:334:GLU:N	1.87	1.06

*Continued on next page...*



*Continued from previous page...*

Atom-1	Atom-2	Interatomic distance (Å)	Clash overlap (Å)
2:E:149:LYS:O	2:E:334:GLU:N	1.87	1.06
1:I:11:GLY:CA	2:N:50:VAL:O	2.02	1.06
1:B:263:THR:CB	2:D:124:ARG:C	2.25	1.05
1:I:259:GLY:N	2:N:296:GLU:CA	2.06	1.05
2:M:149:LYS:O	2:M:334:GLU:N	1.87	1.05
1:A:11:GLY:CA	2:F:50:VAL:O	2.05	1.04
1:B:9:ILE:HA	2:D:50:VAL:CB	1.87	1.04
1:A:352:PRO:CB	2:D:272:ALA:HB3	1.88	1.04
1:A:44:GLY:CA	2:D:69:ALA:CB	2.35	1.03
1:A:69:LEU:CB	1:A:71:LEU:C	2.26	1.03
1:I:44:GLY:CA	2:L:69:ALA:HB3	1.83	1.03
1:B:11:GLY:HA3	2:D:49:GLU:CA	1.88	1.03
3:O:27:LEU:CB	3:O:163:ALA:HB2	1.87	1.03
1:A:44:GLY:N	2:D:69:ALA:CB	2.22	1.03
1:I:11:GLY:HA2	2:N:50:VAL:N	1.66	1.02
1:C:224:ALA:HB1	1:C:405:ALA:HB3	1.41	1.02
1:A:224:ALA:HB1	1:A:405:ALA:HB3	1.41	1.01
1:I:224:ALA:HB1	1:I:405:ALA:HB3	1.41	1.01
4:H:76:GLY:O	4:H:80:ALA:HB3	1.59	1.01
1:I:71:LEU:CB	1:I:189:VAL:H	1.74	1.01
1:K:44:GLY:CA	2:N:69:ALA:CB	2.39	1.00
1:K:224:ALA:HB1	1:K:405:ALA:HB3	1.41	1.00
1:K:259:GLY:O	2:M:296:GLU:O	1.78	1.00
1:K:52:TYR:CB	1:K:295:PRO:CB	2.38	1.00
4:P:62:LEU:O	4:P:63:MET:CB	2.07	0.99
3:O:7:THR:O	3:O:8:ARG:C	1.98	0.99
1:B:224:ALA:HB2	1:B:405:ALA:HB3	1.45	0.99
1:J:224:ALA:HB1	1:J:405:ALA:HB3	1.41	0.99
1:C:24:MET:HA	2:F:66:LEU:HA	1.45	0.99
1:C:419:PHE:C	1:C:496:GLN:HA	1.83	0.98
1:C:11:GLY:HA3	2:E:50:VAL:H	1.28	0.98
2:L:334:GLU:O	2:L:361:LEU:N	1.96	0.98
1:B:24:MET:CB	2:E:66:LEU:N	2.26	0.98
1:J:471:VAL:CB	4:P:98:ILE:O	2.12	0.98
1:B:224:ALA:HB1	1:B:405:ALA:HB3	1.42	0.97
1:I:259:GLY:N	2:N:296:GLU:HA	1.78	0.97
3:G:7:THR:O	3:G:8:ARG:C	1.98	0.97
1:I:11:GLY:HA2	2:N:50:VAL:H	0.81	0.97
1:K:25:TYR:CB	2:N:65:GLY:HA2	1.94	0.97
3:G:199:GLY:O	3:G:203:ALA:HB2	1.63	0.97
1:B:9:ILE:CB	2:D:50:VAL:C	2.32	0.97

*Continued on next page...*

*Continued from previous page...*

Atom-1	Atom-2	Interatomic distance (Å)	Clash overlap (Å)
1:C:224:ALA:HB2	1:C:405:ALA:HB3	1.46	0.97
1:I:43:ASP:CA	2:L:69:ALA:HB2	1.94	0.97
1:J:419:PHE:O	1:J:496:GLN:HA	1.63	0.96
1:K:259:GLY:C	2:M:296:GLU:C	2.22	0.96
1:A:69:LEU:CB	1:A:72:ALA:N	2.27	0.96
1:I:224:ALA:HB2	1:I:405:ALA:HB3	1.46	0.96
2:F:149:LYS:O	2:F:333:THR:HA	1.66	0.96
3:G:199:GLY:C	3:G:203:ALA:HB2	1.86	0.96
1:A:224:ALA:HB2	1:A:405:ALA:HB3	1.46	0.96
3:O:199:GLY:O	3:O:203:ALA:HB2	1.63	0.96
1:K:44:GLY:HA2	2:N:69:ALA:HB2	1.47	0.96
1:C:292:SER:CB	2:E:292:ALA:HB3	1.96	0.96
1:J:224:ALA:HB2	1:J:405:ALA:HB3	1.45	0.96
2:L:150:LEU:HA	2:L:335:GLY:O	1.66	0.96
1:A:11:GLY:HA3	2:F:50:VAL:C	1.86	0.95
1:I:267:VAL:N	2:N:124:ARG:CA	2.24	0.95
2:F:150:LEU:HA	2:F:335:GLY:O	1.66	0.95
1:K:224:ALA:HB2	1:K:405:ALA:HB3	1.46	0.95
1:K:419:PHE:O	1:K:496:GLN:C	2.03	0.95
1:A:69:LEU:CB	1:A:71:LEU:O	2.14	0.95
2:D:150:LEU:HA	2:D:335:GLY:O	1.67	0.95
2:N:150:LEU:HA	2:N:335:GLY:O	1.66	0.95
3:G:148:LYS:O	3:G:152:GLU:CB	2.15	0.95
1:I:259:GLY:O	2:N:296:GLU:C	2.05	0.95
2:N:149:LYS:O	2:N:333:THR:HA	1.66	0.95
1:B:11:GLY:HA3	2:D:49:GLU:HA	1.49	0.94
3:O:47:MET:O	3:O:49:ALA:N	2.00	0.94
3:O:199:GLY:C	3:O:203:ALA:HB2	1.86	0.94
2:E:150:LEU:HA	2:E:335:GLY:O	1.66	0.94
1:I:25:TYR:CB	2:L:65:GLY:HA2	1.96	0.94
2:L:149:LYS:O	2:L:333:THR:HA	1.66	0.94
2:M:150:LEU:HA	2:M:335:GLY:O	1.67	0.94
2:N:134:GLY:O	2:N:429:ASN:HA	1.68	0.94
1:C:267:VAL:O	2:E:125:ARG:HA	1.62	0.94
2:D:149:LYS:O	2:D:333:THR:HA	1.66	0.94
1:C:11:GLY:HA3	2:E:50:VAL:N	1.82	0.94
1:A:44:GLY:CA	2:D:69:ALA:HB3	1.96	0.93
3:O:135:GLU:C	3:O:137:LEU:N	2.17	0.93
3:O:148:LYS:O	3:O:152:GLU:CB	2.15	0.93
2:F:426:GLY:O	1:K:125:PRO:O	1.86	0.93
3:G:47:MET:O	3:G:49:ALA:N	2.00	0.93

*Continued on next page...*

*Continued from previous page...*

Atom-1	Atom-2	Interatomic distance (Å)	Clash overlap (Å)
2:L:149:LYS:O	2:L:333:THR:CA	2.17	0.93
2:N:149:LYS:O	2:N:333:THR:CA	2.16	0.93
4:P:86:VAL:O	4:P:88:GLY:N	2.01	0.93
4:P:77:LEU:O	4:P:78:LYS:C	1.88	0.93
1:A:71:LEU:CB	1:A:72:ALA:HA	1.99	0.93
2:E:149:LYS:O	2:E:333:THR:HA	1.66	0.93
4:P:75:ALA:CB	4:P:85:ASP:O	2.17	0.93
2:F:149:LYS:O	2:F:333:THR:CA	2.16	0.93
2:M:149:LYS:O	2:M:333:THR:HA	1.66	0.93
2:D:149:LYS:O	2:D:333:THR:CA	2.16	0.93
2:E:149:LYS:O	2:E:333:THR:CA	2.17	0.92
1:J:24:MET:CB	2:M:66:LEU:HA	1.99	0.92
1:B:10:ALA:N	2:D:50:VAL:CB	2.31	0.92
1:I:71:LEU:CB	1:I:189:VAL:N	2.33	0.92
3:O:48:GLU:O	3:O:51:LYS:CB	2.18	0.92
3:G:48:GLU:O	3:G:51:LYS:CB	2.18	0.91
1:A:71:LEU:CB	1:A:189:VAL:H	1.83	0.91
1:C:11:GLY:CA	2:E:50:VAL:H	1.82	0.91
1:K:69:LEU:CB	1:K:72:ALA:CB	2.47	0.91
2:M:149:LYS:O	2:M:333:THR:CA	2.17	0.91
1:C:266:LEU:CB	2:E:124:ARG:HA	1.99	0.91
2:E:359:SER:CB	2:E:362:MET:CB	2.49	0.91
4:P:84:HIS:O	4:P:86:VAL:N	2.03	0.90
1:I:43:ASP:O	2:L:69:ALA:CB	2.08	0.90
3:G:49:ALA:O	3:G:52:ALA:HB3	1.72	0.90
4:P:84:HIS:O	4:P:86:VAL:CB	2.19	0.90
3:O:141:ALA:O	3:O:145:THR:CB	2.21	0.89
1:A:44:GLY:CA	2:D:69:ALA:HB1	2.02	0.89
1:K:44:GLY:CA	2:N:69:ALA:HB2	2.03	0.89
4:H:76:GLY:O	4:H:80:ALA:CB	2.20	0.88
3:O:49:ALA:O	3:O:52:ALA:HB3	1.72	0.88
3:G:141:ALA:O	3:G:145:THR:CB	2.21	0.88
2:F:295:TYR:CB	2:F:332:ILE:CB	2.53	0.87
2:E:140:VAL:CB	2:E:435:SER:CB	2.52	0.87
1:I:44:GLY:HA2	2:L:69:ALA:HB3	1.48	0.87
2:M:295:TYR:CB	2:M:332:ILE:CB	2.52	0.87
2:N:295:TYR:CB	2:N:332:ILE:CB	2.53	0.87
2:F:359:SER:CB	2:F:362:MET:CB	2.53	0.86
3:G:135:GLU:C	3:G:137:LEU:N	2.17	0.86
1:K:10:ALA:O	2:M:50:VAL:CB	2.23	0.86
2:D:295:TYR:CB	2:D:332:ILE:CB	2.53	0.86

*Continued on next page...*

*Continued from previous page...*

Atom-1	Atom-2	Interatomic distance (Å)	Clash overlap (Å)
2:L:295:TYR:CB	2:L:332:ILE:CB	2.53	0.86
4:H:77:LEU:H	4:H:80:ALA:HB3	1.41	0.86
2:L:153:PHE:O	2:L:339:LEU:N	2.08	0.86
1:B:10:ALA:O	2:D:49:GLU:HA	1.74	0.86
2:D:134:GLY:HA2	2:D:430:ARG:O	1.76	0.86
1:I:259:GLY:C	2:N:296:GLU:CA	2.44	0.86
1:K:419:PHE:C	1:K:496:GLN:HA	1.95	0.86
1:I:12:PRO:N	2:N:49:GLU:CB	2.39	0.86
1:I:24:MET:HA	2:L:66:LEU:HA	0.86	0.86
2:L:150:LEU:CA	2:L:335:GLY:O	2.24	0.86
2:F:153:PHE:O	2:F:339:LEU:N	2.09	0.86
3:G:47:MET:O	3:G:48:GLU:C	2.09	0.86
2:M:153:PHE:O	2:M:339:LEU:N	2.09	0.86
1:J:263:THR:CB	2:L:125:ARG:N	2.38	0.86
2:E:295:TYR:CB	2:E:332:ILE:CB	2.53	0.86
3:G:174:ALA:O	3:G:175:GLN:C	2.09	0.85
2:F:150:LEU:CA	2:F:335:GLY:O	2.24	0.85
2:M:150:LEU:CA	2:M:335:GLY:O	2.24	0.85
1:C:260:ASN:CB	2:E:298:ALA:HB3	2.06	0.85
2:N:153:PHE:O	2:N:339:LEU:N	2.09	0.85
3:O:47:MET:O	3:O:48:GLU:C	2.09	0.85
3:O:174:ALA:O	3:O:175:GLN:C	2.09	0.85
4:H:77:LEU:N	4:H:80:ALA:HB3	1.91	0.85
2:D:150:LEU:CA	2:D:335:GLY:O	2.24	0.85
1:C:266:LEU:C	2:E:124:ARG:CB	2.45	0.85
2:E:150:LEU:CA	2:E:335:GLY:O	2.24	0.85
1:B:24:MET:CB	2:E:66:LEU:C	2.44	0.85
1:I:11:GLY:CA	2:N:50:VAL:CA	2.50	0.85
1:I:52:TYR:CB	1:I:297:ALA:HB3	2.08	0.84
2:D:153:PHE:O	2:D:339:LEU:N	2.09	0.84
3:O:199:GLY:O	3:O:203:ALA:CB	2.26	0.84
1:B:10:ALA:C	2:D:50:VAL:H	1.79	0.84
1:I:24:MET:C	2:L:66:LEU:H	1.79	0.84
2:N:150:LEU:CA	2:N:335:GLY:O	2.24	0.84
1:C:208:GLY:HA2	1:C:507:CYS:O	1.78	0.84
1:A:43:ASP:C	2:D:69:ALA:CB	2.46	0.83
1:I:25:TYR:N	2:L:66:LEU:N	1.94	0.83
1:I:24:MET:CA	2:L:66:LEU:CA	2.50	0.83
1:I:259:GLY:C	2:N:296:GLU:C	2.37	0.83
2:E:153:PHE:O	2:E:339:LEU:N	2.09	0.83
3:O:158:THR:O	3:O:161:VAL:CB	2.27	0.83

*Continued on next page...*

*Continued from previous page...*

Atom-1	Atom-2	Interatomic distance (Å)	Clash overlap (Å)
3:G:158:THR:O	3:G:161:VAL:CB	2.27	0.82
1:C:18:GLY:O	1:C:19:MET:CB	2.28	0.82
1:I:25:TYR:CA	2:L:65:GLY:HA2	2.09	0.82
3:G:199:GLY:O	3:G:203:ALA:CB	2.25	0.82
1:C:208:GLY:O	1:C:507:CYS:CB	2.28	0.82
1:I:18:GLY:O	1:I:19:MET:CB	2.27	0.82
1:C:189:VAL:CB	1:C:305:VAL:CA	2.58	0.81
1:I:56:SER:CB	2:N:30:GLY:N	2.43	0.81
1:B:263:THR:CB	2:D:125:ARG:CA	2.59	0.81
1:C:344:MET:CB	2:F:272:ALA:HB1	2.11	0.81
3:G:167:VAL:O	3:G:168:VAL:C	2.19	0.80
2:F:427:GLN:CB	1:K:126:GLY:HA3	2.12	0.80
1:K:18:GLY:O	1:K:19:MET:CB	2.28	0.80
3:O:167:VAL:O	3:O:169:ILE:N	2.14	0.80
1:A:259:GLY:N	2:F:296:GLU:HA	1.96	0.80
1:A:43:ASP:C	2:D:69:ALA:HB2	2.02	0.80
1:B:9:ILE:CA	2:D:50:VAL:CB	2.60	0.80
1:J:18:GLY:O	1:J:19:MET:CB	2.28	0.80
1:I:266:LEU:CA	2:N:124:ARG:CB	2.59	0.80
4:H:76:GLY:C	4:H:80:ALA:HB3	2.00	0.80
1:J:224:ALA:HB1	1:J:405:ALA:CB	2.12	0.80
1:A:224:ALA:HB1	1:A:405:ALA:CB	2.12	0.79
1:B:18:GLY:O	1:B:19:MET:CB	2.28	0.79
3:G:167:VAL:O	3:G:169:ILE:N	2.14	0.79
1:I:24:MET:CA	2:L:66:LEU:N	2.46	0.79
1:B:224:ALA:HB1	1:B:405:ALA:CB	2.12	0.79
1:C:224:ALA:HB1	1:C:405:ALA:CB	2.12	0.79
1:I:260:ASN:CB	2:N:298:ALA:O	2.30	0.79
1:K:419:PHE:C	1:K:497:GLN:H	1.86	0.79
3:G:132:ARG:N	3:G:134:ALA:HB3	1.98	0.79
1:I:224:ALA:HB1	1:I:405:ALA:CB	2.12	0.79
1:K:224:ALA:HB1	1:K:405:ALA:CB	2.13	0.79
1:A:71:LEU:CB	1:A:189:VAL:N	2.45	0.78
2:L:334:GLU:CB	2:L:361:LEU:CB	2.60	0.78
1:C:201:PRO:O	1:C:434:ALA:HB1	1.84	0.78
3:O:167:VAL:O	3:O:168:VAL:C	2.19	0.78
3:O:132:ARG:N	3:O:134:ALA:HB3	1.98	0.78
1:C:266:LEU:C	2:E:124:ARG:CA	2.50	0.78
1:A:18:GLY:O	1:A:19:MET:CB	2.28	0.78
1:B:11:GLY:CA	2:D:49:GLU:HA	2.13	0.78
1:C:259:GLY:O	2:E:297:ARG:N	2.16	0.77

*Continued on next page...*

*Continued from previous page...*

Atom-1	Atom-2	Interatomic distance (Å)	Clash overlap (Å)
3:G:28:LEU:O	3:G:31:LYS:CB	2.32	0.77
3:O:28:LEU:O	3:O:31:LYS:CB	2.32	0.77
2:L:359:SER:C	2:L:361:LEU:H	1.86	0.77
2:D:334:GLU:O	2:D:361:LEU:N	2.17	0.77
1:I:267:VAL:H	2:N:124:ARG:CA	1.97	0.77
1:I:419:PHE:CB	1:I:497:GLN:O	2.32	0.77
2:F:51:SER:O	2:F:52:GLU:CB	2.33	0.77
2:M:51:SER:O	2:M:52:GLU:CB	2.33	0.77
1:B:10:ALA:O	2:D:49:GLU:CA	2.33	0.76
1:C:44:GLY:HA2	2:F:69:ALA:HB1	1.67	0.76
1:C:224:ALA:CB	1:C:405:ALA:CB	2.58	0.76
2:L:359:SER:C	2:L:361:LEU:N	2.26	0.76
1:A:11:GLY:HA2	2:F:50:VAL:H	1.47	0.76
1:C:259:GLY:O	2:E:296:GLU:C	2.24	0.76
2:D:51:SER:O	2:D:52:GLU:CB	2.33	0.76
2:L:51:SER:O	2:L:52:GLU:CB	2.33	0.76
1:I:259:GLY:C	2:N:296:GLU:HA	2.04	0.76
1:J:263:THR:CB	2:L:125:ARG:C	2.54	0.76
1:J:419:PHE:O	1:J:496:GLN:CA	2.35	0.75
2:N:51:SER:O	2:N:52:GLU:CB	2.33	0.75
1:I:224:ALA:CB	1:I:405:ALA:CB	2.58	0.75
1:I:71:LEU:CB	1:I:72:ALA:HA	2.17	0.75
3:O:194:LEU:C	3:O:194:LEU:HA	2.04	0.75
2:E:149:LYS:CB	2:E:332:ILE:O	2.35	0.75
1:C:25:TYR:CB	2:F:65:GLY:CA	2.51	0.75
2:E:51:SER:O	2:E:52:GLU:CB	2.33	0.75
2:F:149:LYS:CB	2:F:332:ILE:O	2.35	0.75
2:L:149:LYS:CB	2:L:332:ILE:O	2.35	0.75
1:B:224:ALA:CB	1:B:405:ALA:CB	2.58	0.74
1:B:419:PHE:O	1:B:496:GLN:HA	1.87	0.74
3:G:132:ARG:C	3:G:134:ALA:N	2.37	0.74
1:I:56:SER:CB	2:N:30:GLY:O	2.35	0.74
3:G:199:GLY:C	3:G:203:ALA:CB	2.56	0.74
3:O:140:VAL:O	3:O:144:GLU:CB	2.35	0.74
3:O:199:GLY:C	3:O:203:ALA:CB	2.56	0.74
3:O:132:ARG:C	3:O:134:ALA:N	2.37	0.74
3:G:140:VAL:O	3:G:144:GLU:CB	2.35	0.73
2:M:149:LYS:CB	2:M:332:ILE:O	2.35	0.73
2:N:69:ALA:O	2:N:70:THR:CB	2.36	0.73
3:O:142:ASN:O	3:O:146:ARG:CB	2.36	0.73
3:G:142:ASN:O	3:G:146:ARG:CB	2.36	0.73

*Continued on next page...*

*Continued from previous page...*

Atom-1	Atom-2	Interatomic distance (Å)	Clash overlap (Å)
3:G:196:ARG:C	3:G:196:ARG:HA	2.05	0.73
2:N:149:LYS:CB	2:N:332:ILE:O	2.35	0.73
2:D:149:LYS:CB	2:D:332:ILE:O	2.35	0.73
2:L:69:ALA:O	2:L:70:THR:CB	2.36	0.73
3:O:45:GLU:O	3:O:46:ALA:C	2.27	0.73
1:A:224:ALA:CB	1:A:405:ALA:CB	2.58	0.73
3:G:45:GLU:O	3:G:46:ALA:C	2.27	0.73
1:B:263:THR:CB	2:D:125:ARG:C	2.58	0.73
1:C:292:SER:CB	2:E:292:ALA:CB	2.67	0.73
2:F:69:ALA:O	2:F:70:THR:CB	2.37	0.73
1:I:24:MET:HA	2:L:66:LEU:N	2.04	0.72
2:E:69:ALA:O	2:E:70:THR:CB	2.37	0.72
3:O:150:ILE:O	3:O:151:GLY:O	2.07	0.72
3:G:150:ILE:O	3:G:151:GLY:O	2.08	0.72
3:G:163:ALA:C	3:G:163:ALA:HA	2.04	0.72
4:H:74:ILE:O	4:H:75:ALA:O	2.07	0.72
2:D:69:ALA:O	2:D:70:THR:CB	2.36	0.72
2:M:69:ALA:O	2:M:70:THR:CB	2.37	0.72
2:N:65:GLY:O	2:N:66:LEU:CB	2.38	0.72
1:A:69:LEU:CB	1:A:72:ALA:H	1.99	0.71
1:A:44:GLY:HA2	2:D:69:ALA:HB1	1.63	0.71
3:O:135:GLU:O	3:O:136:ALA:C	2.28	0.71
3:G:4:VAL:C	3:G:4:VAL:HA	2.07	0.71
2:N:359:SER:CB	2:N:362:MET:CB	2.68	0.71
3:O:196:ARG:C	3:O:196:ARG:HA	2.05	0.71
3:G:135:GLU:O	3:G:136:ALA:C	2.28	0.71
1:B:10:ALA:O	2:D:49:GLU:C	2.29	0.71
2:F:65:GLY:O	2:F:66:LEU:CB	2.39	0.70
2:E:65:GLY:O	2:E:66:LEU:CB	2.38	0.70
1:I:225:ALA:N	1:I:405:ALA:O	2.25	0.70
1:A:225:ALA:N	1:A:405:ALA:O	2.25	0.70
2:L:274:ARG:O	2:L:275:GLU:CB	2.37	0.70
2:M:65:GLY:O	2:M:66:LEU:CB	2.38	0.70
1:C:266:LEU:O	2:E:124:ARG:CB	2.40	0.70
1:I:132:GLY:HA3	1:I:371:LEU:CB	2.22	0.70
1:B:471:VAL:CB	4:H:98:ILE:CA	2.69	0.70
1:K:225:ALA:N	1:K:405:ALA:O	2.25	0.70
2:F:274:ARG:O	2:F:275:GLU:CB	2.37	0.69
1:A:259:GLY:CA	2:F:296:GLU:HA	2.21	0.69
2:N:274:ARG:O	2:N:275:GLU:CB	2.37	0.69
2:D:65:GLY:O	2:D:66:LEU:CB	2.38	0.69

*Continued on next page...*

*Continued from previous page...*

Atom-1	Atom-2	Interatomic distance (Å)	Clash overlap (Å)
1:C:225:ALA:N	1:C:405:ALA:O	2.25	0.69
1:J:225:ALA:N	1:J:405:ALA:O	2.25	0.69
1:B:225:ALA:N	1:B:405:ALA:O	2.25	0.69
2:M:274:ARG:O	2:M:275:GLU:CB	2.37	0.69
3:O:31:LYS:N	3:O:31:LYS:HA	2.02	0.69
3:O:48:GLU:C	3:O:51:LYS:H	1.97	0.69
2:L:65:GLY:O	2:L:66:LEU:CB	2.39	0.69
3:O:197:ILE:O	3:O:200:LYS:CB	2.41	0.68
3:O:4:VAL:C	3:O:4:VAL:HA	2.07	0.68
3:G:197:ILE:O	3:G:200:LYS:CB	2.40	0.68
1:A:5:VAL:CB	1:A:18:GLY:O	2.42	0.68
1:J:5:VAL:CB	1:J:18:GLY:O	2.42	0.68
1:K:5:VAL:CB	1:K:18:GLY:O	2.42	0.68
1:B:24:MET:CB	2:E:66:LEU:H	2.06	0.68
1:I:5:VAL:CB	1:I:18:GLY:O	2.42	0.68
2:F:427:GLN:CB	1:K:126:GLY:CA	2.72	0.68
1:J:224:ALA:CB	1:J:405:ALA:CB	2.58	0.68
1:K:224:ALA:CB	1:K:405:ALA:CB	2.58	0.68
2:D:359:SER:C	2:D:361:LEU:N	2.41	0.68
2:E:274:ARG:O	2:E:275:GLU:CB	2.37	0.67
3:G:48:GLU:C	3:G:51:LYS:H	1.97	0.67
1:C:5:VAL:CB	1:C:18:GLY:O	2.42	0.67
2:F:61:GLU:HA	2:F:229:ILE:CB	2.25	0.67
3:G:194:LEU:C	3:G:194:LEU:HA	2.04	0.67
1:I:292:SER:CB	2:N:292:ALA:HB3	2.24	0.67
1:B:5:VAL:CB	1:B:18:GLY:O	2.42	0.67
3:G:151:GLY:HA2	3:G:155:LYS:CB	2.25	0.67
2:D:274:ARG:O	2:D:275:GLU:CB	2.37	0.67
3:G:31:LYS:N	3:G:31:LYS:HA	2.02	0.67
3:O:151:GLY:HA2	3:O:155:LYS:CB	2.26	0.66
1:C:352:PRO:CB	2:F:269:GLU:C	2.63	0.66
3:G:3:GLN:O	3:G:5:SER:N	2.29	0.66
4:P:86:VAL:O	4:P:89:TYR:N	2.29	0.66
1:A:71:LEU:CB	1:A:72:ALA:CA	2.74	0.66
1:B:24:MET:HA	2:E:67:ASP:O	1.96	0.66
3:O:141:ALA:HA	3:O:144:GLU:CB	2.26	0.66
3:O:3:GLN:O	3:O:5:SER:N	2.29	0.66
1:C:260:ASN:N	2:E:296:GLU:HA	2.09	0.66
1:K:189:VAL:O	1:K:304:TYR:CB	2.44	0.66
3:G:141:ALA:HA	3:G:144:GLU:CB	2.26	0.66
1:K:266:LEU:CB	2:M:124:ARG:CB	2.74	0.66

*Continued on next page...*



*Continued from previous page...*

Atom-1	Atom-2	Interatomic distance (Å)	Clash overlap (Å)
1:C:352:PRO:CB	2:F:269:GLU:O	2.44	0.65
1:A:11:GLY:CA	2:F:50:VAL:H	2.10	0.65
1:J:263:THR:CB	2:L:124:ARG:C	2.65	0.65
2:M:61:GLU:O	2:M:227:PRO:CB	2.44	0.65
2:M:149:LYS:O	2:M:333:THR:C	2.35	0.65
1:A:292:SER:CB	2:F:292:ALA:HB1	2.26	0.65
1:K:26:ASP:O	1:K:71:LEU:N	2.30	0.65
2:L:334:GLU:O	2:L:361:LEU:CB	2.44	0.65
2:N:149:LYS:O	2:N:333:THR:C	2.35	0.65
2:E:149:LYS:O	2:E:333:THR:C	2.35	0.65
2:F:149:LYS:O	2:F:333:THR:C	2.35	0.65
1:K:132:GLY:HA3	1:K:371:LEU:CB	2.27	0.65
3:O:163:ALA:C	3:O:163:ALA:HA	2.04	0.65
3:O:172:ILE:O	3:O:176:ILE:CB	2.45	0.64
1:I:71:LEU:CB	1:I:188:PRO:C	2.64	0.64
2:L:149:LYS:O	2:L:333:THR:C	2.35	0.64
1:I:44:GLY:HA2	2:L:69:ALA:HB1	1.53	0.64
2:F:426:GLY:O	1:K:125:PRO:CB	2.46	0.64
3:G:141:ALA:HA	3:G:145:THR:H	1.62	0.64
3:O:156:LYS:C	3:O:158:THR:N	2.44	0.64
1:B:11:GLY:CA	2:D:49:GLU:CB	2.66	0.64
3:G:156:LYS:C	3:G:158:THR:N	2.44	0.64
1:K:11:GLY:HA3	2:M:49:GLU:CA	2.28	0.64
3:O:156:LYS:O	3:O:157:THR:C	2.33	0.64
2:D:149:LYS:O	2:D:333:THR:C	2.35	0.64
3:G:172:ILE:O	3:G:176:ILE:CB	2.45	0.64
1:I:25:TYR:O	2:L:65:GLY:HA2	1.97	0.64
1:A:259:GLY:CA	2:F:296:GLU:CA	2.73	0.63
3:O:141:ALA:HA	3:O:145:THR:H	1.62	0.63
1:I:346:ALA:HB2	2:L:272:ALA:HB1	1.80	0.63
1:K:11:GLY:CA	2:M:49:GLU:HA	2.29	0.63
1:B:71:LEU:O	1:B:72:ALA:HB2	1.98	0.63
3:G:151:GLY:O	3:G:152:GLU:C	2.36	0.63
2:E:134:GLY:O	2:E:429:ASN:HA	1.97	0.63
1:K:56:SER:CB	2:M:30:GLY:O	2.47	0.63
3:O:151:GLY:O	3:O:152:GLU:C	2.37	0.63
1:A:259:GLY:N	2:F:296:GLU:CA	2.62	0.63
1:A:259:GLY:H	2:F:296:GLU:CA	2.11	0.63
4:H:62:LEU:O	4:H:63:MET:C	2.34	0.63
1:I:346:ALA:HB2	2:L:272:ALA:CB	2.29	0.63
2:N:76:VAL:O	2:N:77:GLU:CB	2.47	0.63

*Continued on next page...*

*Continued from previous page...*

Atom-1	Atom-2	Interatomic distance (Å)	Clash overlap (Å)
3:G:18:LEU:O	3:G:21:ALA:HB3	1.99	0.63
1:I:70:PRO:CB	1:I:190:ARG:CB	2.77	0.63
3:O:156:LYS:HA	3:O:159:ARG:H	1.64	0.63
2:F:76:VAL:O	2:F:77:GLU:CB	2.47	0.63
1:B:25:TYR:O	2:E:65:GLY:CA	2.40	0.62
3:O:148:LYS:O	3:O:149:LYS:O	2.17	0.62
2:E:76:VAL:O	2:E:77:GLU:CB	2.47	0.62
2:L:76:VAL:O	2:L:77:GLU:CB	2.47	0.62
3:G:156:LYS:HA	3:G:159:ARG:H	1.64	0.62
1:I:267:VAL:CA	2:N:124:ARG:CB	2.74	0.62
3:O:18:LEU:O	3:O:21:ALA:HB3	1.99	0.62
3:G:156:LYS:O	3:G:157:THR:C	2.33	0.62
3:O:135:GLU:C	3:O:137:LEU:H	2.03	0.62
1:K:25:TYR:CB	2:N:65:GLY:CA	2.74	0.62
1:I:259:GLY:O	2:N:296:GLU:O	2.18	0.62
1:J:10:ALA:O	2:L:49:GLU:HA	1.99	0.61
1:K:11:GLY:HA3	2:M:49:GLU:CB	2.30	0.61
3:O:41:GLY:O	3:O:42:LEU:C	2.38	0.61
2:D:76:VAL:O	2:D:77:GLU:CB	2.47	0.61
3:G:41:GLY:O	3:G:42:LEU:C	2.38	0.61
3:O:27:LEU:CB	3:O:163:ALA:CB	2.73	0.61
1:A:69:LEU:C	1:A:71:LEU:O	2.37	0.61
3:G:148:LYS:O	3:G:149:LYS:O	2.17	0.61
2:E:61:GLU:O	2:E:227:PRO:CB	2.48	0.61
4:H:77:LEU:H	4:H:80:ALA:CB	2.12	0.61
1:A:259:GLY:H	2:F:296:GLU:N	1.97	0.61
1:I:24:MET:CA	2:L:66:LEU:H	2.08	0.61
1:I:11:GLY:CA	2:N:50:VAL:CB	2.78	0.61
2:M:76:VAL:O	2:M:77:GLU:CB	2.47	0.61
3:O:170:PRO:O	3:O:174:ALA:HB2	2.00	0.61
4:H:84:HIS:C	4:H:86:VAL:N	2.53	0.61
1:I:25:TYR:CB	2:L:64:THR:O	2.49	0.61
1:A:11:GLY:HA3	2:F:50:VAL:CA	2.31	0.61
3:G:170:PRO:O	3:G:174:ALA:HB2	2.00	0.61
1:B:10:ALA:H	2:D:50:VAL:CA	2.14	0.60
1:C:44:GLY:HA2	2:F:69:ALA:HB2	1.77	0.60
3:G:135:GLU:O	3:G:137:LEU:N	2.33	0.60
1:C:12:PRO:N	2:E:49:GLU:CB	2.64	0.60
1:I:25:TYR:O	2:L:65:GLY:CA	2.49	0.60
3:O:158:THR:C	3:O:161:VAL:CB	2.70	0.60
4:P:84:HIS:O	4:P:86:VAL:CA	2.48	0.60

*Continued on next page...*

*Continued from previous page...*

Atom-1	Atom-2	Interatomic distance (Å)	Clash overlap (Å)
1:C:12:PRO:O	1:C:13:ALA:HB3	2.02	0.60
3:G:158:THR:C	3:G:161:VAL:CB	2.70	0.60
2:D:359:SER:C	2:D:361:LEU:H	2.04	0.60
1:I:12:PRO:O	1:I:13:ALA:HB3	2.01	0.60
1:A:12:PRO:O	1:A:13:ALA:HB3	2.01	0.60
3:G:160:ARG:O	3:G:164:LEU:CB	2.50	0.60
1:A:43:ASP:C	2:D:69:ALA:HB3	2.22	0.60
1:K:11:GLY:HA3	2:M:50:VAL:H	1.66	0.60
1:J:12:PRO:O	1:J:13:ALA:HB3	2.02	0.59
1:K:12:PRO:O	1:K:13:ALA:HB3	2.02	0.59
1:I:241:LEU:O	1:I:245:SER:N	2.33	0.59
1:K:27:ILE:HA	1:K:71:LEU:H	1.68	0.59
2:D:334:GLU:CB	2:D:361:LEU:CB	2.80	0.59
1:I:25:TYR:H	2:L:66:LEU:H	0.61	0.59
3:G:135:GLU:HA	3:G:138:ILE:N	2.17	0.59
1:I:56:SER:CB	2:N:30:GLY:CA	2.81	0.59
3:O:150:ILE:C	3:O:151:GLY:O	2.39	0.59
1:A:44:GLY:N	2:D:69:ALA:HB1	2.08	0.59
1:B:12:PRO:O	1:B:13:ALA:HB3	2.01	0.59
3:O:135:GLU:HA	3:O:138:ILE:N	2.17	0.59
1:K:70:PRO:CB	1:K:71:LEU:O	2.50	0.59
3:O:135:GLU:O	3:O:137:LEU:N	2.33	0.59
3:O:160:ARG:O	3:O:164:LEU:CB	2.50	0.59
1:J:263:THR:CB	2:L:125:ARG:CA	2.80	0.59
1:B:9:ILE:CB	2:D:52:GLU:N	2.66	0.59
1:I:292:SER:CB	2:N:292:ALA:CB	2.81	0.58
3:G:150:ILE:C	3:G:151:GLY:O	2.39	0.58
1:A:44:GLY:N	2:D:69:ALA:HB2	2.11	0.58
1:C:197:ARG:O	1:C:368:VAL:HA	2.04	0.58
1:I:208:GLY:O	1:I:507:CYS:O	2.21	0.58
1:J:24:MET:HA	2:M:67:ASP:O	2.04	0.58
2:L:134:GLY:HA2	2:L:430:ARG:O	2.04	0.58
1:C:189:VAL:O	1:C:304:TYR:O	2.22	0.57
1:C:344:MET:CB	2:F:272:ALA:CB	2.81	0.57
3:G:47:MET:C	3:G:49:ALA:N	2.57	0.57
4:H:84:HIS:C	4:H:86:VAL:H	2.06	0.57
1:A:267:VAL:CB	2:F:125:ARG:HA	2.34	0.57
1:I:11:GLY:N	2:N:50:VAL:O	2.38	0.57
3:O:186:ARG:O	3:O:190:ASP:CB	2.53	0.57
3:G:47:MET:C	3:G:49:ALA:H	2.08	0.57
1:J:241:LEU:O	1:J:245:SER:N	2.33	0.57

*Continued on next page...*

*Continued from previous page...*

Atom-1	Atom-2	Interatomic distance (Å)	Clash overlap (Å)
1:C:52:TYR:C	1:C:295:PRO:CB	2.69	0.57
1:C:420:PRO:N	1:C:496:GLN:HA	2.19	0.57
1:K:259:GLY:O	2:M:297:ARG:N	2.34	0.57
1:K:241:LEU:O	1:K:245:SER:N	2.32	0.56
1:C:241:LEU:O	1:C:245:SER:N	2.31	0.56
3:G:135:GLU:C	3:G:137:LEU:H	2.03	0.56
1:I:352:PRO:CB	2:L:269:GLU:O	2.53	0.56
1:I:419:PHE:HA	1:I:420:PRO:C	2.25	0.56
3:G:186:ARG:O	3:G:190:ASP:CB	2.53	0.56
1:I:25:TYR:N	2:L:65:GLY:HA2	2.19	0.56
2:M:334:GLU:O	2:M:360:ARG:N	2.37	0.56
3:O:47:MET:C	3:O:49:ALA:H	2.09	0.56
3:O:48:GLU:O	3:O:51:LYS:N	2.38	0.56
3:O:132:ARG:O	3:O:133:TYR:C	2.38	0.56
1:A:241:LEU:O	1:A:245:SER:CB	2.54	0.56
1:J:263:THR:CB	2:L:125:ARG:O	2.53	0.56
3:O:47:MET:C	3:O:49:ALA:N	2.57	0.56
1:C:419:PHE:HA	1:C:420:PRO:C	2.25	0.56
1:I:25:TYR:CB	2:L:65:GLY:CA	2.79	0.56
2:N:136:SER:CB	2:N:430:ARG:CB	2.84	0.56
4:P:86:VAL:O	4:P:87:GLU:C	2.44	0.56
3:G:137:LEU:O	3:G:140:VAL:CB	2.54	0.56
3:G:189:GLU:CB	3:G:189:GLU:HA	2.18	0.56
1:K:419:PHE:HA	1:K:420:PRO:C	2.25	0.56
1:B:419:PHE:HA	1:B:420:PRO:C	2.25	0.56
1:C:430:LEU:O	1:C:432:THR:N	2.38	0.56
1:C:344:MET:CB	2:F:272:ALA:CA	2.84	0.56
3:O:45:GLU:C	3:O:47:MET:N	2.58	0.56
3:G:132:ARG:N	3:G:134:ALA:CB	2.68	0.56
1:I:25:TYR:H	2:L:65:GLY:C	2.04	0.56
1:I:266:LEU:CB	2:N:124:ARG:CA	2.82	0.56
3:O:137:LEU:O	3:O:140:VAL:CB	2.54	0.55
3:O:158:THR:HA	3:O:161:VAL:CB	2.37	0.55
3:G:142:ASN:CB	3:G:142:ASN:HA	2.17	0.55
2:L:359:SER:CB	2:L:362:MET:H	2.18	0.55
1:C:266:LEU:CB	2:E:124:ARG:CA	2.80	0.55
3:G:132:ARG:O	3:G:133:TYR:C	2.37	0.55
1:J:419:PHE:HA	1:J:420:PRO:C	2.25	0.55
3:O:142:ASN:CB	3:O:142:ASN:HA	2.16	0.55
3:G:48:GLU:O	3:G:51:LYS:N	2.39	0.55
1:I:25:TYR:C	2:L:65:GLY:HA2	2.26	0.55

*Continued on next page...*

*Continued from previous page...*

Atom-1	Atom-2	Interatomic distance (Å)	Clash overlap (Å)
1:K:11:GLY:HA2	2:M:49:GLU:HA	1.88	0.55
3:G:44:ARG:C	3:G:47:MET:CB	2.72	0.55
1:K:10:ALA:O	2:M:50:VAL:N	2.39	0.55
1:A:419:PHE:HA	1:A:420:PRO:C	2.25	0.55
3:O:136:ALA:O	3:O:140:VAL:CB	2.55	0.54
3:O:137:LEU:O	3:O:140:VAL:N	2.40	0.54
4:P:77:LEU:O	4:P:78:LYS:O	2.23	0.54
1:B:241:LEU:O	1:B:245:SER:N	2.31	0.54
3:G:158:THR:HA	3:G:161:VAL:CB	2.37	0.54
1:I:56:SER:CB	2:N:30:GLY:H	2.20	0.54
1:K:189:VAL:CB	1:K:304:TYR:CB	2.85	0.54
1:A:25:TYR:H	2:D:66:LEU:H	1.56	0.54
1:A:71:LEU:CB	1:A:188:PRO:C	2.76	0.54
3:G:137:LEU:O	3:G:140:VAL:N	2.40	0.54
1:J:24:MET:CB	2:M:66:LEU:CA	2.80	0.54
3:G:136:ALA:O	3:G:140:VAL:CB	2.55	0.54
1:I:225:ALA:O	1:I:406:PHE:HA	2.07	0.54
1:K:225:ALA:O	1:K:406:PHE:HA	2.07	0.54
3:O:7:THR:O	3:O:9:MET:N	2.41	0.54
1:A:292:SER:CB	2:F:292:ALA:CB	2.86	0.53
1:A:296:VAL:HA	1:A:333:ALA:HB1	1.90	0.53
2:E:153:PHE:CB	2:E:338:GLN:HA	2.38	0.53
3:G:167:VAL:C	3:G:169:ILE:N	2.61	0.53
3:O:132:ARG:N	3:O:134:ALA:CB	2.68	0.53
1:A:225:ALA:O	1:A:406:PHE:HA	2.08	0.53
1:B:225:ALA:O	1:B:406:PHE:HA	2.08	0.53
1:C:225:ALA:O	1:C:406:PHE:HA	2.08	0.53
1:B:224:ALA:CA	1:B:405:ALA:HB3	2.37	0.53
1:I:259:GLY:O	2:N:297:ARG:N	2.42	0.53
1:J:227:PRO:HA	1:J:384:VAL:CB	2.39	0.53
1:J:296:VAL:HA	1:J:333:ALA:HB1	1.90	0.53
1:K:224:ALA:CA	1:K:405:ALA:HB3	2.37	0.53
3:O:44:ARG:C	3:O:47:MET:CB	2.72	0.53
3:G:138:ILE:O	3:G:139:ARG:O	2.27	0.53
1:K:44:GLY:CA	2:N:69:ALA:HB3	2.14	0.53
4:P:86:VAL:C	4:P:88:GLY:N	2.62	0.53
1:B:296:VAL:HA	1:B:333:ALA:HB1	1.90	0.53
1:C:430:LEU:C	1:C:432:THR:H	2.12	0.53
2:L:153:PHE:CB	2:L:338:GLN:HA	2.39	0.53
1:C:259:GLY:C	2:E:296:GLU:C	2.65	0.53
2:F:426:GLY:O	1:K:125:PRO:CA	2.57	0.53

*Continued on next page...*

*Continued from previous page...*

Atom-1	Atom-2	Interatomic distance (Å)	Clash overlap (Å)
4:H:76:GLY:O	4:H:80:ALA:HB1	2.06	0.53
4:H:77:LEU:O	4:H:78:LYS:C	2.32	0.53
1:I:132:GLY:HA3	1:I:371:LEU:C	2.28	0.53
2:M:153:PHE:CB	2:M:338:GLN:HA	2.39	0.53
3:O:42:LEU:O	3:O:45:GLU:CB	2.57	0.53
3:O:145:THR:O	3:O:149:LYS:CB	2.57	0.53
1:A:227:PRO:HA	1:A:384:VAL:CB	2.39	0.53
2:D:153:PHE:CB	2:D:338:GLN:HA	2.39	0.53
3:G:166:GLN:O	3:G:169:ILE:CB	2.57	0.53
1:A:224:ALA:CA	1:A:405:ALA:HB3	2.37	0.53
1:A:419:PHE:C	1:A:497:GLN:O	2.47	0.53
1:C:296:VAL:HA	1:C:333:ALA:HB1	1.91	0.53
2:F:153:PHE:CB	2:F:338:GLN:HA	2.39	0.53
1:I:43:ASP:HA	2:L:69:ALA:HB2	1.88	0.53
1:I:227:PRO:HA	1:I:384:VAL:CB	2.39	0.53
1:I:260:ASN:N	2:N:296:GLU:HA	2.23	0.53
2:N:153:PHE:CB	2:N:338:GLN:HA	2.39	0.53
3:O:138:ILE:O	3:O:139:ARG:O	2.27	0.53
1:A:419:PHE:CB	1:A:497:GLN:O	2.56	0.53
3:G:39:PHE:O	3:G:42:LEU:CB	2.57	0.53
1:B:227:PRO:HA	1:B:384:VAL:CB	2.39	0.52
1:C:227:PRO:HA	1:C:384:VAL:CB	2.39	0.52
3:G:145:THR:O	3:G:149:LYS:CB	2.57	0.52
1:C:266:LEU:C	2:E:124:ARG:HA	2.30	0.52
1:A:81:ASN:HA	1:A:282:MET:O	2.10	0.52
3:G:45:GLU:C	3:G:47:MET:N	2.58	0.52
1:I:189:VAL:HA	1:I:308:THR:CB	2.39	0.52
1:I:296:VAL:HA	1:I:333:ALA:HB1	1.91	0.52
3:G:141:ALA:CA	3:G:145:THR:H	2.22	0.52
1:J:225:ALA:O	1:J:406:PHE:HA	2.08	0.52
3:O:173:ARG:O	3:O:177:ARG:CB	2.58	0.52
3:G:165:GLU:O	3:G:166:GLN:C	2.47	0.52
1:K:227:PRO:HA	1:K:384:VAL:CB	2.39	0.52
2:N:334:GLU:O	2:N:360:ARG:N	2.43	0.52
3:G:138:ILE:C	3:G:139:ARG:O	2.45	0.52
3:O:166:GLN:O	3:O:169:ILE:CB	2.57	0.52
1:J:69:LEU:C	1:J:70:PRO:O	2.47	0.52
2:L:359:SER:CA	2:L:362:MET:H	2.23	0.52
1:A:52:TYR:O	1:A:53:GLU:CB	2.58	0.52
3:G:42:LEU:O	3:G:45:GLU:CB	2.57	0.52
1:I:44:GLY:N	2:L:69:ALA:HB2	1.76	0.52

*Continued on next page...*

*Continued from previous page...*

Atom-1	Atom-2	Interatomic distance (Å)	Clash overlap (Å)
3:O:167:VAL:C	3:O:169:ILE:N	2.61	0.52
1:C:52:TYR:O	1:C:53:GLU:CB	2.58	0.52
1:K:11:GLY:HA3	2:M:49:GLU:HA	1.90	0.52
1:I:52:TYR:O	1:I:53:GLU:CB	2.58	0.52
1:I:259:GLY:O	2:N:298:ALA:N	2.43	0.52
1:K:52:TYR:O	1:K:53:GLU:CB	2.58	0.51
1:I:224:ALA:CA	1:I:405:ALA:HB3	2.37	0.51
1:B:52:TYR:O	1:B:53:GLU:CB	2.58	0.51
1:B:224:ALA:HB2	1:B:405:ALA:CB	2.31	0.51
1:I:204:PRO:CB	1:I:435:LEU:CB	2.89	0.51
1:K:296:VAL:HA	1:K:333:ALA:HB1	1.90	0.51
3:O:165:GLU:O	3:O:166:GLN:C	2.47	0.51
3:O:205:GLU:CB	3:O:205:GLU:N	2.67	0.51
3:G:52:ALA:CB	3:G:52:ALA:C	2.74	0.51
3:O:141:ALA:CA	3:O:145:THR:H	2.22	0.51
1:C:202:ASN:HA	1:C:434:ALA:O	2.11	0.51
3:G:7:THR:O	3:G:9:MET:N	2.42	0.51
3:G:171:GLY:O	3:G:174:ALA:HB3	2.11	0.51
3:G:173:ARG:O	3:G:177:ARG:CB	2.58	0.51
3:O:171:GLY:O	3:O:174:ALA:HB3	2.11	0.51
3:O:52:ALA:CB	3:O:52:ALA:C	2.74	0.51
3:O:138:ILE:C	3:O:139:ARG:O	2.45	0.51
1:I:266:LEU:CB	2:N:124:ARG:HA	2.41	0.51
3:G:183:LEU:O	3:G:186:ARG:CB	2.59	0.51
1:J:71:LEU:O	1:J:188:PRO:HA	2.10	0.50
3:O:183:LEU:O	3:O:186:ARG:CB	2.60	0.50
1:A:69:LEU:O	1:A:71:LEU:O	2.29	0.50
4:P:84:HIS:O	4:P:85:ASP:C	2.47	0.50
1:A:43:ASP:O	2:D:69:ALA:HB3	2.12	0.50
1:C:73:VAL:O	1:C:186:THR:HA	2.12	0.50
3:G:194:LEU:C	3:G:194:LEU:CB	2.73	0.50
1:J:52:TYR:O	1:J:53:GLU:CB	2.58	0.50
1:K:11:GLY:HA3	2:M:50:VAL:N	2.27	0.50
3:O:132:ARG:C	3:O:134:ALA:H	2.13	0.50
1:A:73:VAL:O	1:A:186:THR:HA	2.12	0.50
1:A:266:LEU:CB	2:F:124:ARG:CA	2.89	0.50
3:O:148:LYS:O	3:O:152:GLU:CA	2.59	0.50
2:F:426:GLY:C	1:K:125:PRO:O	2.48	0.50
3:G:146:ARG:O	3:G:147:LEU:C	2.50	0.50
1:J:224:ALA:CA	1:J:405:ALA:HB3	2.37	0.50
1:K:216:PHE:HA	1:K:429:SER:CB	2.42	0.50

*Continued on next page...*

*Continued from previous page...*

Atom-1	Atom-2	Interatomic distance (Å)	Clash overlap (Å)
1:B:73:VAL:O	1:B:186:THR:HA	2.12	0.49
3:G:132:ARG:C	3:G:134:ALA:H	2.13	0.49
2:L:150:LEU:CB	2:L:335:GLY:O	2.60	0.49
2:N:149:LYS:O	2:N:333:THR:CB	2.59	0.49
1:C:352:PRO:O	2:F:269:GLU:CB	2.60	0.49
1:J:73:VAL:O	1:J:186:THR:HA	2.11	0.49
1:J:224:ALA:HB2	1:J:405:ALA:CB	2.31	0.49
1:K:73:VAL:O	1:K:186:THR:HA	2.12	0.49
3:O:142:ASN:CB	3:O:142:ASN:N	2.67	0.49
1:A:11:GLY:CA	2:F:50:VAL:N	2.73	0.49
2:E:149:LYS:O	2:E:333:THR:CB	2.59	0.49
2:F:149:LYS:O	2:F:333:THR:CB	2.59	0.49
3:G:205:GLU:CB	3:G:205:GLU:N	2.66	0.49
1:J:9:ILE:CA	2:L:50:VAL:O	2.57	0.49
3:O:43:VAL:O	3:O:44:ARG:C	2.51	0.49
1:C:344:MET:CB	2:F:272:ALA:HA	2.42	0.49
2:D:149:LYS:O	2:D:333:THR:CB	2.59	0.49
3:G:146:ARG:O	3:G:149:LYS:N	2.45	0.49
3:G:148:LYS:O	3:G:152:GLU:CA	2.59	0.49
3:O:146:ARG:O	3:O:149:LYS:N	2.45	0.49
1:K:557:GLU:C	1:K:559:PHE:N	2.66	0.49
2:N:61:GLU:HA	2:N:229:ILE:CB	2.42	0.49
3:O:7:THR:O	3:O:8:ARG:O	2.30	0.49
3:O:49:ALA:O	3:O:52:ALA:CB	2.53	0.49
1:A:557:GLU:C	1:A:559:PHE:N	2.66	0.49
2:E:150:LEU:CB	2:E:335:GLY:O	2.61	0.49
1:J:557:GLU:C	1:J:559:PHE:N	2.66	0.49
1:J:9:ILE:HA	2:L:50:VAL:CB	2.42	0.49
2:M:150:LEU:CB	2:M:335:GLY:O	2.61	0.49
2:N:150:LEU:CB	2:N:335:GLY:O	2.61	0.49
1:A:259:GLY:H	2:F:296:GLU:HA	1.68	0.49
2:D:150:LEU:CB	2:D:335:GLY:O	2.60	0.49
3:G:43:VAL:O	3:G:44:ARG:C	2.51	0.49
2:L:149:LYS:O	2:L:333:THR:CB	2.59	0.49
3:O:198:LYS:O	3:O:199:GLY:O	2.31	0.49
3:O:146:ARG:O	3:O:147:LEU:C	2.50	0.49
4:H:84:HIS:O	4:H:85:ASP:C	2.43	0.49
2:M:149:LYS:O	2:M:333:THR:CB	2.60	0.49
3:O:134:ALA:O	3:O:137:LEU:CB	2.61	0.48
1:B:557:GLU:C	1:B:559:PHE:N	2.66	0.48
3:G:198:LYS:O	3:G:199:GLY:O	2.31	0.48

*Continued on next page...*



*Continued from previous page...*

Atom-1	Atom-2	Interatomic distance (Å)	Clash overlap (Å)
1:I:24:MET:CB	2:L:66:LEU:N	2.76	0.48
1:I:73:VAL:O	1:I:186:THR:HA	2.12	0.48
1:I:557:GLU:C	1:I:559:PHE:N	2.66	0.48
1:K:260:ASN:N	2:M:296:GLU:HA	1.95	0.48
3:O:3:GLN:O	3:O:6:PRO:N	2.46	0.48
3:O:198:LYS:O	3:O:199:GLY:C	2.52	0.48
1:C:44:GLY:HA2	2:F:69:ALA:HB3	1.84	0.48
1:C:224:ALA:CA	1:C:405:ALA:HB3	2.37	0.48
3:G:3:GLN:O	3:G:6:PRO:N	2.47	0.48
3:G:134:ALA:O	3:G:137:LEU:CB	2.62	0.48
1:I:440:ARG:HA	1:I:444:ALA:O	2.14	0.48
1:J:440:ARG:HA	1:J:444:ALA:O	2.14	0.48
3:O:200:LYS:HA	3:O:203:ALA:HB3	1.96	0.48
3:O:138:ILE:O	3:O:142:ASN:CB	2.62	0.48
1:C:189:VAL:HA	1:C:308:THR:CB	2.43	0.48
1:C:557:GLU:C	1:C:559:PHE:N	2.66	0.48
3:O:48:GLU:CB	3:O:51:LYS:CB	2.92	0.48
2:F:150:LEU:CB	2:F:335:GLY:O	2.61	0.48
3:G:135:GLU:HA	3:G:138:ILE:H	1.79	0.48
3:G:198:LYS:O	3:G:199:GLY:C	2.52	0.48
3:G:4:VAL:CA	3:G:5:SER:N	2.68	0.47
3:O:153:GLU:O	3:O:154:ILE:O	2.32	0.47
1:B:11:GLY:HA2	2:D:48:ILE:O	2.14	0.47
3:G:153:GLU:O	3:G:154:ILE:O	2.32	0.47
1:A:440:ARG:HA	1:A:444:ALA:O	2.14	0.47
3:G:167:VAL:C	3:G:169:ILE:H	2.18	0.47
3:O:167:VAL:C	3:O:169:ILE:H	2.18	0.47
4:P:65:GLY:CA	4:P:66:ARG:CB	2.93	0.47
1:C:24:MET:CA	2:F:66:LEU:HA	2.31	0.47
3:G:48:GLU:CB	3:G:51:LYS:CB	2.92	0.47
1:K:44:GLY:HA3	2:N:69:ALA:CB	2.40	0.47
3:G:138:ILE:O	3:G:142:ASN:CB	2.62	0.47
1:K:267:VAL:N	2:M:124:ARG:CB	2.78	0.47
1:K:440:ARG:HA	1:K:444:ALA:O	2.14	0.47
2:E:150:LEU:C	2:E:335:GLY:O	2.53	0.47
2:F:150:LEU:C	2:F:335:GLY:O	2.53	0.47
2:M:150:LEU:C	2:M:335:GLY:O	2.53	0.47
3:G:200:LYS:HA	3:G:203:ALA:HB3	1.96	0.47
3:O:135:GLU:HA	3:O:138:ILE:H	1.80	0.47
1:C:440:ARG:HA	1:C:444:ALA:O	2.14	0.47
2:L:150:LEU:C	2:L:335:GLY:O	2.52	0.47

*Continued on next page...*

*Continued from previous page...*

Atom-1	Atom-2	Interatomic distance (Å)	Clash overlap (Å)
1:B:9:ILE:CA	2:D:50:VAL:O	2.53	0.46
1:B:440:ARG:HA	1:B:444:ALA:O	2.14	0.46
2:D:150:LEU:C	2:D:335:GLY:O	2.53	0.46
1:K:11:GLY:CA	2:M:49:GLU:CB	2.93	0.46
3:O:200:LYS:CA	3:O:203:ALA:HB3	2.45	0.46
1:C:189:VAL:CB	1:C:305:VAL:N	2.78	0.46
1:J:86:GLY:HA2	1:J:302:SER:CB	2.46	0.46
1:J:419:PHE:O	1:J:496:GLN:CB	2.63	0.46
1:B:475:ALA:O	4:H:102:ILE:CB	2.63	0.46
3:G:49:ALA:O	3:G:52:ALA:CB	2.53	0.46
2:M:134:GLY:O	2:M:429:ASN:HA	2.14	0.46
1:I:71:LEU:CB	1:I:72:ALA:CA	2.92	0.46
2:N:150:LEU:C	2:N:335:GLY:O	2.53	0.46
1:A:224:ALA:HB2	1:A:405:ALA:CB	2.31	0.46
1:C:25:TYR:CA	2:F:65:GLY:HA2	2.36	0.46
2:D:359:SER:CB	2:D:362:MET:H	2.28	0.46
3:G:200:LYS:CA	3:G:203:ALA:HB3	2.45	0.46
3:O:194:LEU:C	3:O:194:LEU:CB	2.73	0.46
3:G:7:THR:O	3:G:8:ARG:O	2.30	0.46
3:G:40:PHE:O	3:G:43:VAL:N	2.49	0.45
3:G:138:ILE:CB	4:H:16:ALA:CB	2.94	0.45
1:I:352:PRO:CB	2:L:272:ALA:HB3	2.47	0.45
1:I:11:GLY:HA3	2:N:50:VAL:CB	2.38	0.45
2:L:334:GLU:CA	2:L:361:LEU:CB	2.94	0.45
1:I:475:ALA:HB1	2:L:398:ILE:O	2.16	0.45
3:O:52:ALA:O	3:O:55:GLN:O	2.34	0.45
3:G:35:LEU:O	3:G:38:GLU:CB	2.65	0.45
1:I:44:GLY:N	2:L:69:ALA:HB3	1.77	0.45
1:I:241:LEU:O	1:I:245:SER:CB	2.64	0.45
1:K:70:PRO:N	1:K:72:ALA:HB2	2.32	0.45
3:O:35:LEU:O	3:O:38:GLU:CB	2.65	0.45
1:C:266:LEU:CB	2:E:124:ARG:CB	2.94	0.45
3:G:52:ALA:O	3:G:55:GLN:O	2.34	0.45
1:J:241:LEU:O	1:J:245:SER:CB	2.64	0.45
1:K:241:LEU:O	1:K:245:SER:CB	2.64	0.45
2:L:334:GLU:O	2:L:361:LEU:CA	2.63	0.45
1:C:268:GLU:CB	2:E:126:LYS:CB	2.94	0.45
3:G:151:GLY:O	3:G:152:GLU:O	2.35	0.45
1:I:132:GLY:HA3	1:I:371:LEU:O	2.17	0.45
1:K:296:VAL:CA	1:K:333:ALA:HB1	2.47	0.45
3:G:179:ILE:O	3:G:180:GLN:C	2.56	0.45

*Continued on next page...*

*Continued from previous page...*

Atom-1	Atom-2	Interatomic distance (Å)	Clash overlap (Å)
1:K:189:VAL:C	1:K:304:TYR:CB	2.85	0.45
3:O:4:VAL:CA	3:O:5:SER:N	2.68	0.45
1:A:352:PRO:CB	2:D:269:GLU:O	2.64	0.45
1:C:131:GLY:O	1:C:371:LEU:CB	2.65	0.45
3:O:179:ILE:O	3:O:180:GLN:C	2.55	0.45
1:A:11:GLY:HA3	2:F:50:VAL:N	2.32	0.44
1:C:296:VAL:CA	1:C:333:ALA:HB1	2.47	0.44
3:G:142:ASN:CB	3:G:142:ASN:N	2.67	0.44
3:G:189:GLU:CB	3:G:189:GLU:N	2.69	0.44
3:G:141:ALA:HB1	3:G:145:THR:CB	2.47	0.44
1:J:296:VAL:CA	1:J:333:ALA:HB1	2.47	0.44
1:K:259:GLY:H	2:M:296:GLU:CB	2.20	0.44
1:C:81:ASN:N	1:C:282:MET:O	2.46	0.44
1:C:314:ARG:HA	1:C:318:PHE:O	2.18	0.44
2:D:153:PHE:O	2:D:338:GLN:HA	2.17	0.44
3:O:141:ALA:HB1	3:O:145:THR:CB	2.47	0.44
1:B:296:VAL:CA	1:B:333:ALA:HB1	2.47	0.44
3:G:45:GLU:O	3:G:47:MET:N	2.50	0.44
1:J:314:ARG:HA	1:J:318:PHE:O	2.17	0.44
1:A:296:VAL:CA	1:A:333:ALA:HB1	2.47	0.44
3:G:175:GLN:O	3:G:177:ARG:N	2.51	0.44
1:K:11:GLY:CA	2:M:49:GLU:CA	2.92	0.44
3:O:175:GLN:O	3:O:177:ARG:N	2.51	0.44
1:A:314:ARG:HA	1:A:318:PHE:O	2.18	0.44
1:B:314:ARG:HA	1:B:318:PHE:O	2.18	0.44
3:O:151:GLY:O	3:O:152:GLU:O	2.35	0.44
2:E:153:PHE:O	2:E:338:GLN:HA	2.18	0.44
1:I:296:VAL:CA	1:I:333:ALA:HB1	2.47	0.44
1:K:314:ARG:HA	1:K:318:PHE:O	2.18	0.44
3:O:45:GLU:O	3:O:47:MET:N	2.50	0.44
1:B:9:ILE:C	2:D:50:VAL:CB	2.86	0.44
2:L:153:PHE:O	2:L:338:GLN:HA	2.18	0.44
3:O:167:VAL:C	3:O:167:VAL:HA	2.16	0.44
2:N:349:TYR:HA	2:N:350:PRO:C	2.38	0.43
1:A:44:GLY:N	2:D:69:ALA:HB3	2.12	0.43
1:A:71:LEU:CA	1:A:189:VAL:H	2.27	0.43
2:D:349:TYR:HA	2:D:350:PRO:C	2.38	0.43
1:I:314:ARG:HA	1:I:318:PHE:O	2.18	0.43
2:N:153:PHE:O	2:N:338:GLN:HA	2.18	0.43
4:P:86:VAL:C	4:P:88:GLY:H	2.19	0.43
1:B:471:VAL:CB	4:H:98:ILE:HA	2.48	0.43

*Continued on next page...*

*Continued from previous page...*

Atom-1	Atom-2	Interatomic distance (Å)	Clash overlap (Å)
1:K:208:GLY:O	1:K:507:CYS:O	2.35	0.43
1:K:224:ALA:HB2	1:K:405:ALA:CB	2.32	0.43
2:M:153:PHE:O	2:M:338:GLN:HA	2.18	0.43
1:K:69:LEU:CA	1:K:72:ALA:CB	2.97	0.43
1:B:263:THR:CA	2:D:124:ARG:C	2.86	0.43
1:I:69:LEU:CB	1:I:71:LEU:N	2.82	0.43
1:I:255:CYS:HA	1:I:290:ASN:CB	2.49	0.43
1:J:75:LEU:O	1:J:184:TYR:HA	2.19	0.43
2:M:349:TYR:HA	2:M:350:PRO:C	2.39	0.43
2:F:258:THR:HA	2:F:259:ASP:HA	1.85	0.43
3:O:4:VAL:C	3:O:6:PRO:N	2.71	0.43
3:O:189:GLU:CB	3:O:189:GLU:N	2.69	0.43
1:K:75:LEU:O	1:K:184:TYR:HA	2.19	0.43
3:O:40:PHE:O	3:O:43:VAL:CB	2.67	0.43
3:O:140:VAL:O	3:O:144:GLU:N	2.47	0.43
3:O:189:GLU:CB	3:O:189:GLU:HA	2.18	0.43
1:A:255:CYS:HA	1:A:290:ASN:CB	2.49	0.43
1:B:241:LEU:O	1:B:245:SER:CB	2.67	0.43
2:E:258:THR:HA	2:E:259:ASP:HA	1.85	0.43
2:F:427:GLN:CB	1:K:126:GLY:HA2	2.46	0.43
3:G:135:GLU:O	3:G:139:ARG:CB	2.67	0.43
3:G:175:GLN:O	3:G:178:PHE:N	2.51	0.43
3:O:135:GLU:O	3:O:139:ARG:CB	2.67	0.43
2:F:349:TYR:HA	2:F:350:PRO:C	2.39	0.42
1:K:255:CYS:HA	1:K:290:ASN:CB	2.49	0.42
1:B:255:CYS:HA	1:B:290:ASN:CB	2.49	0.42
1:J:266:LEU:CB	2:L:124:ARG:CB	2.97	0.42
1:K:52:TYR:C	1:K:295:PRO:CB	2.77	0.42
1:C:241:LEU:O	1:C:245:SER:CB	2.67	0.42
2:F:153:PHE:O	2:F:338:GLN:HA	2.18	0.42
3:O:174:ALA:O	3:O:175:GLN:O	2.37	0.42
1:B:75:LEU:O	1:B:184:TYR:HA	2.19	0.42
2:D:189:VAL:O	2:D:217:SER:HA	2.19	0.42
3:G:40:PHE:O	3:G:43:VAL:CB	2.67	0.42
1:I:25:TYR:O	2:L:65:GLY:HA3	2.16	0.42
1:I:346:ALA:HB2	2:L:272:ALA:HB2	2.01	0.42
2:L:349:TYR:HA	2:L:350:PRO:C	2.38	0.42
1:C:75:LEU:O	1:C:184:TYR:HA	2.19	0.42
2:E:189:VAL:O	2:E:217:SER:HA	2.20	0.42
1:I:25:TYR:N	2:L:65:GLY:CA	2.82	0.42
1:J:255:CYS:HA	1:J:290:ASN:CB	2.49	0.42

*Continued on next page...*

*Continued from previous page...*

Atom-1	Atom-2	Interatomic distance (Å)	Clash overlap (Å)
2:L:189:VAL:O	2:L:217:SER:HA	2.20	0.42
1:B:70:PRO:O	1:B:71:LEU:CB	2.68	0.42
1:A:241:LEU:O	1:A:244:TRP:O	2.38	0.42
2:E:349:TYR:HA	2:E:350:PRO:C	2.39	0.42
1:I:75:LEU:O	1:I:184:TYR:HA	2.18	0.42
1:K:69:LEU:CA	1:K:72:ALA:HB2	2.49	0.42
1:A:133:MET:O	1:A:148:LEU:HA	2.20	0.42
2:F:189:VAL:O	2:F:217:SER:HA	2.20	0.42
3:G:4:VAL:C	3:G:6:PRO:N	2.71	0.42
1:J:429:SER:C	1:J:431:PHE:H	2.23	0.42
1:C:430:LEU:C	1:C:432:THR:N	2.73	0.42
1:A:221:GLY:O	1:A:366:GLY:HA2	2.21	0.41
1:C:260:ASN:HA	2:E:296:GLU:O	2.20	0.41
1:J:133:MET:O	1:J:148:LEU:HA	2.20	0.41
3:O:175:GLN:O	3:O:178:PHE:N	2.51	0.41
1:A:75:LEU:O	1:A:184:TYR:HA	2.19	0.41
1:B:227:PRO:CB	1:B:384:VAL:CB	2.98	0.41
1:K:227:PRO:CB	1:K:384:VAL:CB	2.99	0.41
2:M:189:VAL:O	2:M:217:SER:HA	2.20	0.41
3:O:48:GLU:O	3:O:51:LYS:CA	2.67	0.41
1:C:202:ASN:O	1:C:435:LEU:HA	2.20	0.41
3:O:134:ALA:O	4:P:16:ALA:HB2	2.19	0.41
1:B:221:GLY:O	1:B:366:GLY:HA2	2.21	0.41
1:C:25:TYR:N	2:F:66:LEU:N	2.31	0.41
1:C:133:MET:O	1:C:148:LEU:HA	2.20	0.41
1:C:255:CYS:HA	1:C:290:ASN:CB	2.49	0.41
3:G:43:VAL:O	3:G:45:GLU:N	2.54	0.41
2:L:359:SER:O	2:L:361:LEU:N	2.53	0.41
2:N:189:VAL:O	2:N:217:SER:HA	2.20	0.41
1:B:133:MET:O	1:B:148:LEU:HA	2.20	0.41
2:D:149:LYS:CB	2:D:333:THR:HA	2.51	0.41
1:K:133:MET:O	1:K:148:LEU:HA	2.21	0.41
2:F:149:LYS:CB	2:F:333:THR:HA	2.51	0.41
1:A:56:SER:CB	2:F:30:GLY:H	2.34	0.41
1:B:9:ILE:CB	2:D:51:SER:C	2.89	0.41
1:B:141:PHE:O	1:B:143:PHE:O	2.39	0.41
1:C:11:GLY:CA	2:E:50:VAL:N	2.57	0.41
1:I:133:MET:O	1:I:148:LEU:HA	2.21	0.41
1:K:221:GLY:O	1:K:366:GLY:HA2	2.21	0.41
3:O:148:LYS:C	3:O:149:LYS:O	2.59	0.41
1:K:141:PHE:O	1:K:143:PHE:O	2.39	0.41

*Continued on next page...*

Continued from previous page...

Atom-1	Atom-2	Interatomic distance (Å)	Clash overlap (Å)
1:A:227:PRO:CB	1:A:384:VAL:CB	2.99	0.41
1:C:141:PHE:O	1:C:143:PHE:O	2.39	0.41
1:C:221:GLY:O	1:C:366:GLY:HA2	2.21	0.41
1:I:227:PRO:CB	1:I:384:VAL:CB	2.99	0.41
1:J:221:GLY:O	1:J:366:GLY:HA2	2.20	0.41
2:N:149:LYS:CB	2:N:333:THR:HA	2.51	0.41
3:O:43:VAL:O	3:O:45:GLU:N	2.54	0.41
1:C:81:ASN:HA	1:C:282:MET:O	2.21	0.41
3:G:48:GLU:O	3:G:51:LYS:CA	2.68	0.41
3:G:146:ARG:O	3:G:149:LYS:CB	2.68	0.41
1:J:208:GLY:O	1:J:507:CYS:N	2.53	0.41
2:L:359:SER:CB	2:L:362:MET:N	2.83	0.41
1:C:227:PRO:CB	1:C:384:VAL:CB	2.99	0.40
3:G:174:ALA:O	3:G:175:GLN:O	2.36	0.40
1:I:221:GLY:O	1:I:366:GLY:HA2	2.21	0.40
1:A:226:ILE:O	1:A:384:VAL:N	2.55	0.40
1:I:226:ILE:O	1:I:384:VAL:N	2.55	0.40
2:M:149:LYS:CB	2:M:333:THR:HA	2.51	0.40
3:O:146:ARG:O	3:O:149:LYS:CB	2.69	0.40
4:P:94:VAL:O	4:P:95:ARG:C	2.58	0.40
1:A:259:GLY:C	2:F:296:GLU:HA	2.41	0.40
3:G:148:LYS:C	3:G:149:LYS:O	2.60	0.40
1:I:24:MET:CB	2:L:66:LEU:CA	2.99	0.40
1:J:141:PHE:O	1:J:143:PHE:O	2.39	0.40
1:K:27:ILE:HA	1:K:71:LEU:N	2.33	0.40
2:L:149:LYS:CB	2:L:333:THR:HA	2.51	0.40
2:N:258:THR:HA	2:N:259:ASP:HA	1.85	0.40
1:A:259:GLY:O	2:F:296:GLU:O	2.39	0.40
1:C:226:ILE:O	1:C:384:VAL:N	2.55	0.40
1:I:141:PHE:O	1:I:143:PHE:O	2.39	0.40
1:J:226:ILE:O	1:J:384:VAL:N	2.55	0.40
1:J:227:PRO:CB	1:J:384:VAL:CB	2.99	0.40
2:L:334:GLU:O	2:L:360:ARG:C	2.56	0.40

All (3) symmetry-related close contacts are listed below. The label for Atom-2 includes the symmetry operator and encoded unit-cell translations to be applied.

Atom-1	Atom-2	Interatomic distance (Å)	Clash overlap (Å)
1:J:6:ILE:CB	2:M:24:ALA:O[5_555]	1.43	0.77
1:J:1:MET:N	2:M:9:THR:CA[5_555]	1.83	0.37
1:J:5:VAL:CA	2:M:24:ALA:CB[5_555]	1.92	0.28

## 5.3 Torsion angles

### 5.3.1 Protein backbone

In the following table, the Percentiles column shows the percent Ramachandran outliers of the chain as a percentile score with respect to all X-ray entries followed by that with respect to entries of similar resolution.

The Analysed column shows the number of residues for which the backbone conformation was analysed, and the total number of residues.

Mol	Chain	Analysed	Favoured	Allowed	Outliers	Percentiles	
1	A	557/578 (96%)	488 (88%)	52 (9%)	17 (3%)	4	30
1	B	557/578 (96%)	493 (88%)	48 (9%)	16 (3%)	4	31
1	C	557/578 (96%)	491 (88%)	48 (9%)	18 (3%)	4	30
1	I	557/578 (96%)	491 (88%)	50 (9%)	16 (3%)	4	31
1	J	557/578 (96%)	492 (88%)	48 (9%)	17 (3%)	4	30
1	K	557/578 (96%)	493 (88%)	47 (8%)	17 (3%)	4	30
2	D	446/478 (93%)	420 (94%)	17 (4%)	9 (2%)	7	39
2	E	446/478 (93%)	421 (94%)	16 (4%)	9 (2%)	7	39
2	F	446/478 (93%)	421 (94%)	16 (4%)	9 (2%)	7	39
2	L	446/478 (93%)	419 (94%)	17 (4%)	10 (2%)	6	37
2	M	446/478 (93%)	422 (95%)	15 (3%)	9 (2%)	7	39
2	N	446/478 (93%)	422 (95%)	15 (3%)	9 (2%)	7	39
3	G	125/223 (56%)	76 (61%)	20 (16%)	29 (23%)	0	1
3	O	125/223 (56%)	76 (61%)	20 (16%)	29 (23%)	0	1
4	H	102/104 (98%)	87 (85%)	9 (9%)	6 (6%)	1	19
4	P	102/104 (98%)	86 (84%)	11 (11%)	5 (5%)	2	22
All	All	6472/6990 (93%)	5798 (90%)	449 (7%)	225 (4%)	3	28

All (225) Ramachandran outliers are listed below:

Mol	Chain	Res	Type
1	A	12	PRO
1	A	19	MET
1	A	53	GLU
1	A	143	PHE
1	A	227	PRO
1	A	256	GLY

*Continued on next page...*

*Continued from previous page...*

<b>Mol</b>	<b>Chain</b>	<b>Res</b>	<b>Type</b>
1	A	260	ASN
1	A	325	ASP
1	A	394	PRO
1	A	395	VAL
1	A	558	GLU
1	B	12	PRO
1	B	19	MET
1	B	53	GLU
1	B	143	PHE
1	B	227	PRO
1	B	256	GLY
1	B	260	ASN
1	B	325	ASP
1	B	394	PRO
1	B	395	VAL
1	B	558	GLU
1	C	12	PRO
1	C	19	MET
1	C	53	GLU
1	C	143	PHE
1	C	227	PRO
1	C	256	GLY
1	C	260	ASN
1	C	325	ASP
1	C	394	PRO
1	C	395	VAL
1	C	431	PHE
1	C	558	GLU
2	D	52	GLU
2	D	79	VAL
2	D	316	MET
2	D	356	PRO
2	D	427	GLN
2	E	52	GLU
2	E	79	VAL
2	E	316	MET
2	E	356	PRO
2	E	427	GLN
2	F	52	GLU
2	F	316	MET
2	F	356	PRO
2	F	427	GLN

*Continued on next page...*



*Continued from previous page...*

<b>Mol</b>	<b>Chain</b>	<b>Res</b>	<b>Type</b>
3	G	3	GLN
3	G	4	VAL
3	G	43	VAL
3	G	47	MET
3	G	48	GLU
3	G	140	VAL
3	G	149	LYS
3	G	152	GLU
3	G	161	VAL
3	G	172	ILE
3	G	174	ALA
4	H	63	MET
4	H	66	ARG
4	H	75	ALA
4	H	85	ASP
4	H	100	PHE
1	I	12	PRO
1	I	19	MET
1	I	53	GLU
1	I	143	PHE
1	I	227	PRO
1	I	256	GLY
1	I	260	ASN
1	I	325	ASP
1	I	394	PRO
1	I	395	VAL
1	I	558	GLU
1	J	12	PRO
1	J	19	MET
1	J	53	GLU
1	J	143	PHE
1	J	227	PRO
1	J	256	GLY
1	J	260	ASN
1	J	325	ASP
1	J	394	PRO
1	J	395	VAL
1	J	430	LEU
1	J	558	GLU
1	K	12	PRO
1	K	19	MET
1	K	53	GLU

*Continued on next page...*

*Continued from previous page...*

<b>Mol</b>	<b>Chain</b>	<b>Res</b>	<b>Type</b>
1	K	143	PHE
1	K	227	PRO
1	K	256	GLY
1	K	260	ASN
1	K	325	ASP
1	K	394	PRO
1	K	395	VAL
1	K	558	GLU
2	L	52	GLU
2	L	79	VAL
2	L	81	ARG
2	L	316	MET
2	L	356	PRO
2	L	427	GLN
2	M	52	GLU
2	M	316	MET
2	M	356	PRO
2	M	427	GLN
2	N	52	GLU
2	N	316	MET
2	N	356	PRO
2	N	427	GLN
3	O	3	GLN
3	O	4	VAL
3	O	43	VAL
3	O	47	MET
3	O	48	GLU
3	O	140	VAL
3	O	149	LYS
3	O	152	GLU
3	O	161	VAL
3	O	172	ILE
3	O	174	ALA
3	O	200	LYS
4	P	63	MET
4	P	86	VAL
4	P	87	GLU
4	P	100	PHE
1	A	88	GLN
1	A	255	CYS
1	B	88	GLN
1	B	255	CYS

*Continued on next page...*

*Continued from previous page...*

<b>Mol</b>	<b>Chain</b>	<b>Res</b>	<b>Type</b>
1	C	88	GLN
1	C	199	LEU
1	C	255	CYS
2	D	26	ASP
2	D	428	GLN
2	E	26	ASP
2	E	428	GLN
2	F	26	ASP
2	F	428	GLN
3	G	2	SER
3	G	6	PRO
3	G	150	ILE
3	G	151	GLY
3	G	185	GLN
3	G	200	LYS
4	H	64	ARG
1	I	88	GLN
1	I	255	CYS
1	J	88	GLN
1	J	255	CYS
1	K	71	LEU
1	K	88	GLN
1	K	255	CYS
2	L	26	ASP
2	L	428	GLN
2	M	26	ASP
2	M	79	VAL
2	M	428	GLN
2	N	26	ASP
2	N	428	GLN
3	O	2	SER
3	O	6	PRO
3	O	13	GLN
3	O	150	ILE
3	O	151	GLY
3	O	185	GLN
1	A	109	HIS
1	B	109	HIS
1	C	109	HIS
3	G	13	GLN
3	G	139	ARG
3	G	155	LYS

*Continued on next page...*

*Continued from previous page...*

<b>Mol</b>	<b>Chain</b>	<b>Res</b>	<b>Type</b>
3	G	162	ASN
3	G	165	GLU
1	I	109	HIS
1	J	109	HIS
1	K	109	HIS
3	O	139	ARG
3	O	155	LYS
3	O	162	ASN
3	O	165	GLU
1	A	71	LEU
3	G	45	GLU
3	G	186	ARG
2	N	79	VAL
3	O	45	GLU
3	O	137	LEU
3	O	186	ARG
4	P	85	ASP
1	A	374	GLU
1	B	374	GLU
1	C	374	GLU
2	D	317	PRO
2	E	317	PRO
2	F	317	PRO
3	G	53	LEU
3	G	137	LEU
3	G	197	ILE
1	I	374	GLU
1	J	374	GLU
1	K	374	GLU
2	L	317	PRO
2	M	317	PRO
2	N	317	PRO
3	O	53	LEU
2	F	79	VAL
3	O	197	ILE
2	D	355	LEU
2	E	355	LEU
2	F	355	LEU
2	L	355	LEU
2	M	355	LEU
2	N	355	LEU
1	A	388	GLY

*Continued on next page...*

*Continued from previous page...*

Mol	Chain	Res	Type
1	B	388	GLY
1	C	388	GLY
3	G	179	ILE
1	I	388	GLY
1	J	388	GLY
1	K	388	GLY
3	O	179	ILE
3	G	168	VAL
3	O	168	VAL

### 5.3.2 Protein sidechains [i](#)

There are no protein residues with a non-rotameric sidechain to report in this entry.

### 5.3.3 RNA [i](#)

There are no RNA molecules in this entry.

### 5.4 Non-standard residues in protein, DNA, RNA chains [i](#)

There are no non-standard protein/DNA/RNA residues in this entry.

### 5.5 Carbohydrates [i](#)

There are no monosaccharides in this entry.

### 5.6 Ligand geometry [i](#)

There are no ligands in this entry.

### 5.7 Other polymers [i](#)

There are no such residues in this entry.

### 5.8 Polymer linkage issues [i](#)

There are no chain breaks in this entry.

## 6 Fit of model and data i

### 6.1 Protein, DNA and RNA chains i

In the following table, the column labelled ‘#RSRZ > 2’ contains the number (and percentage) of RSRZ outliers, followed by percent RSRZ outliers for the chain as percentile scores relative to all X-ray entries and entries of similar resolution. The OWAB column contains the minimum, median, 95<sup>th</sup> percentile and maximum values of the occupancy-weighted average B-factor per residue. The column labelled ‘Q < 0.9’ lists the number of (and percentage) of residues with an average occupancy less than 0.9.

Mol	Chain	Analysed	<RSRZ>	#RSRZ>2	OWAB(Å <sup>2</sup> )	Q<0.9
1	A	561/578 (97%)	0.42	66 (11%) <span style="border: 1px solid red; padding: 2px;">4</span> <span style="border: 1px solid red; padding: 2px;">5</span>	168, 196, 399, 399	0
1	B	561/578 (97%)	-0.07	21 (3%) <span style="border: 1px solid red; padding: 2px;">41</span> <span style="border: 1px solid red; padding: 2px;">34</span>	97, 98, 159, 159	0
1	C	561/578 (97%)	0.50	64 (11%) <span style="border: 1px solid red; padding: 2px;">5</span> <span style="border: 1px solid red; padding: 2px;">6</span>	208, 224, 414, 414	0
1	I	561/578 (97%)	0.64	84 (14%) <span style="border: 1px solid red; padding: 2px;">2</span> <span style="border: 1px solid red; padding: 2px;">3</span>	198, 211, 393, 393	0
1	J	561/578 (97%)	-0.22	11 (1%) <span style="border: 1px solid blue; padding: 2px;">65</span> <span style="border: 1px solid blue; padding: 2px;">56</span>	90, 94, 161, 161	0
1	K	561/578 (97%)	0.78	86 (15%) <span style="border: 1px solid red; padding: 2px;">2</span> <span style="border: 1px solid red; padding: 2px;">3</span>	207, 219, 403, 403	0
2	D	450/478 (94%)	0.13	34 (7%) <span style="border: 1px solid red; padding: 2px;">13</span> <span style="border: 1px solid red; padding: 2px;">12</span>	138, 159, 262, 262	0
2	E	450/478 (94%)	0.25	37 (8%) <span style="border: 1px solid red; padding: 2px;">11</span> <span style="border: 1px solid red; padding: 2px;">11</span>	157, 157, 176, 176	0
2	F	450/478 (94%)	0.33	49 (10%) <span style="border: 1px solid red; padding: 2px;">5</span> <span style="border: 1px solid red; padding: 2px;">6</span>	155, 241, 275, 275	0
2	L	450/478 (94%)	0.25	37 (8%) <span style="border: 1px solid red; padding: 2px;">11</span> <span style="border: 1px solid red; padding: 2px;">11</span>	145, 154, 244, 244	0
2	M	450/478 (94%)	0.22	32 (7%) <span style="border: 1px solid red; padding: 2px;">16</span> <span style="border: 1px solid red; padding: 2px;">13</span>	151, 151, 191, 191	0
2	N	450/478 (94%)	0.75	68 (15%) <span style="border: 1px solid red; padding: 2px;">2</span> <span style="border: 1px solid red; padding: 2px;">3</span>	181, 256, 256, 256	0
3	G	129/223 (57%)	-0.71	0 <span style="border: 1px solid blue; padding: 2px;">100</span> <span style="border: 1px solid blue; padding: 2px;">100</span>	71, 85, 85, 85	0
3	O	129/223 (57%)	-0.43	1 (0%) <span style="border: 1px solid blue; padding: 2px;">86</span> <span style="border: 1px solid blue; padding: 2px;">79</span>	89, 89, 105, 105	0
4	H	104/104 (100%)	0.03	8 (7%) <span style="border: 1px solid red; padding: 2px;">13</span> <span style="border: 1px solid red; padding: 2px;">12</span>	159, 185, 185, 185	0
4	P	104/104 (100%)	0.02	9 (8%) <span style="border: 1px solid red; padding: 2px;">10</span> <span style="border: 1px solid red; padding: 2px;">9</span>	159, 167, 167, 167	0
All	All	6532/6990 (93%)	0.29	607 (9%) <span style="border: 1px solid red; padding: 2px;">8</span> <span style="border: 1px solid red; padding: 2px;">8</span>	71, 176, 399, 414	0

All (607) RSRZ outliers are listed below:

Mol	Chain	Res	Type	RSRZ
1	K	78	GLY	21.1
1	K	77	PRO	20.6
1	A	155	GLY	12.5
1	C	376	GLY	10.5
2	N	191	PHE	10.4

*Continued on next page...*

*Continued from previous page...*

<b>Mol</b>	<b>Chain</b>	<b>Res</b>	<b>Type</b>	<b>RSRZ</b>
2	D	67	ASP	10.3
1	C	77	PRO	10.1
2	L	20	PHE	10.1
1	K	76	GLY	9.6
1	I	78	GLY	9.3
4	H	24	SER	9.0
1	I	77	PRO	8.9
2	N	192	ALA	8.7
2	M	121	PRO	8.4
2	L	121	PRO	8.2
2	D	68	LEU	8.1
4	P	85	ASP	8.0
1	K	345	PRO	7.9
2	M	302	GLU	7.9
2	D	28	ALA	7.9
1	A	128	GLU	7.8
2	E	120	ASN	7.7
1	I	134	VAL	7.7
2	L	21	VAL	7.6
2	N	66	LEU	7.5
2	L	122	VAL	7.5
1	A	129	VAL	7.4
2	L	77	GLU	7.3
2	M	300	VAL	7.2
2	N	193	ALA	7.2
2	L	56	VAL	7.1
1	C	47	ALA	7.0
1	I	164	GLY	7.0
2	N	184	GLU	6.9
2	M	301	VAL	6.9
1	I	155	GLY	6.9
1	K	117	TRP	6.8
2	E	173	VAL	6.8
1	K	122	MET	6.8
1	C	379	THR	6.8
1	A	162	PRO	6.7
1	K	65	VAL	6.7
2	N	121	PRO	6.7
1	I	41	ARG	6.7
1	A	577	LEU	6.5
1	K	165	GLU	6.5
2	N	218	VAL	6.4

*Continued on next page...*

*Continued from previous page...*

<b>Mol</b>	<b>Chain</b>	<b>Res</b>	<b>Type</b>	<b>RSRZ</b>
2	F	122	VAL	6.4
2	M	122	VAL	6.4
2	N	83	GLY	6.4
4	H	76	GLY	6.3
2	L	40	GLY	6.3
1	J	471	VAL	6.3
1	C	183	MET	6.2
1	K	324	ALA	6.2
1	I	180	GLU	6.1
2	E	300	VAL	6.1
1	A	346	ALA	6.0
1	C	377	ALA	6.0
1	C	78	GLY	6.0
1	A	345	PRO	5.9
2	N	118	PRO	5.9
4	P	75	ALA	5.9
2	N	80	ALA	5.8
2	F	121	PRO	5.8
1	K	193	ARG	5.8
2	L	302	GLU	5.6
1	A	193	ARG	5.6
1	A	13	ALA	5.6
1	A	163	ALA	5.6
2	N	67	ASP	5.6
1	K	79	MET	5.5
1	I	42	LEU	5.4
2	N	122	VAL	5.4
1	C	368	VAL	5.3
1	A	181	LEU	5.3
4	P	104	LEU	5.3
1	K	346	ALA	5.3
1	K	121	PRO	5.3
1	I	69	LEU	5.3
2	E	172	THR	5.2
1	C	179	THR	5.2
2	E	118	PRO	5.1
1	K	194	PRO	5.1
2	N	23	ASN	5.1
2	N	194	MET	5.1
1	K	551	ALA	5.1
2	F	86	LYS	5.0
2	E	119	LEU	5.0

*Continued on next page...*



*Continued from previous page...*

<b>Mol</b>	<b>Chain</b>	<b>Res</b>	<b>Type</b>	<b>RSRZ</b>
1	C	140	GLU	5.0
1	I	58	LEU	5.0
2	D	121	PRO	4.9
2	D	102	GLY	4.9
2	N	190	VAL	4.8
1	A	156	ARG	4.8
2	L	75	LEU	4.8
1	K	164	GLY	4.8
1	K	376	GLY	4.8
1	C	320	VAL	4.7
1	A	57	GLY	4.7
2	N	359	SER	4.7
1	A	61	GLY	4.7
1	K	118	ALA	4.7
2	L	39	THR	4.6
1	C	29	LYS	4.6
1	K	314	ARG	4.6
1	C	182	LYS	4.6
2	M	360	ARG	4.5
2	N	84	VAL	4.5
1	I	135	LEU	4.5
2	N	24	ALA	4.5
1	C	150	PRO	4.4
2	F	298	ALA	4.4
1	I	372	GLY	4.4
1	I	218	VAL	4.4
2	N	140	VAL	4.4
2	E	121	PRO	4.3
1	K	510	LYS	4.3
2	N	358	LEU	4.3
1	I	181	LEU	4.3
2	D	27	LEU	4.3
1	A	134	VAL	4.3
1	A	12	PRO	4.3
1	C	37	GLY	4.3
2	F	299	GLY	4.3
1	B	478	ASP	4.3
1	K	202	ASN	4.3
1	A	146	LYS	4.3
2	L	76	VAL	4.3
1	K	576	ALA	4.2
2	M	299	GLY	4.2

*Continued on next page...*

*Continued from previous page...*

<b>Mol</b>	<b>Chain</b>	<b>Res</b>	<b>Type</b>	<b>RSRZ</b>
2	F	365	GLY	4.2
2	F	28	ALA	4.2
1	A	154	ARG	4.2
1	C	187	TRP	4.2
2	N	25	LYS	4.2
1	K	195	VAL	4.2
1	C	375	GLU	4.2
2	F	278	PRO	4.1
2	N	242	ALA	4.1
2	E	463	TYR	4.1
1	I	563	PHE	4.1
1	K	123	VAL	4.1
2	N	28	ALA	4.1
2	F	189	VAL	4.1
1	K	197	ARG	4.1
2	E	168	ALA	4.0
1	K	323	MET	4.0
2	E	150	LEU	4.0
1	I	129	VAL	4.0
1	K	382	GLY	3.9
1	A	210	ARG	3.9
2	L	301	VAL	3.9
1	I	146	LYS	3.9
2	D	22	GLU	3.9
1	I	122	MET	3.9
1	I	158	LYS	3.9
1	I	365	ALA	3.9
1	A	194	PRO	3.9
1	A	58	LEU	3.9
1	K	108	VAL	3.9
1	A	166	TYR	3.8
1	K	550	ARG	3.8
2	E	335	GLY	3.8
2	F	221	LEU	3.8
1	K	186	THR	3.8
1	C	3	GLN	3.8
1	A	200	ASP	3.8
2	M	175	PRO	3.8
1	A	554	VAL	3.8
1	A	173	VAL	3.8
1	A	182	LYS	3.7
2	F	302	GLU	3.7

*Continued on next page...*

*Continued from previous page...*

<b>Mol</b>	<b>Chain</b>	<b>Res</b>	<b>Type</b>	<b>RSRZ</b>
2	L	123	ALA	3.7
1	K	88	GLN	3.7
1	A	77	PRO	3.7
1	A	576	ALA	3.7
1	I	32	GLU	3.7
1	I	40	ILE	3.7
1	B	388	GLY	3.7
1	C	124	LYS	3.7
2	N	185	GLU	3.7
1	I	70	PRO	3.7
1	C	165	GLU	3.7
1	C	171	PRO	3.6
1	C	58	LEU	3.6
1	I	471	VAL	3.6
2	N	455	SER	3.6
1	K	251	VAL	3.6
1	I	165	GLU	3.6
2	F	21	VAL	3.6
2	E	28	ALA	3.6
1	I	296	VAL	3.6
2	M	118	PRO	3.6
1	J	345	PRO	3.6
2	D	120	ASN	3.6
1	A	62	GLU	3.6
1	I	367	LYS	3.6
2	F	225	ASP	3.5
1	I	12	PRO	3.5
2	D	122	VAL	3.5
2	F	297	ARG	3.5
2	L	120	ASN	3.5
1	I	128	GLU	3.5
2	D	44	GLY	3.5
2	F	155	GLY	3.5
1	C	1	MET	3.5
1	A	201	PRO	3.5
2	E	299	GLY	3.5
1	K	47	ALA	3.5
2	N	258	THR	3.5
1	I	557	GLU	3.5
1	C	16	ALA	3.5
1	I	84	TYR	3.5
2	L	104	PRO	3.5

*Continued on next page...*

*Continued from previous page...*

<b>Mol</b>	<b>Chain</b>	<b>Res</b>	<b>Type</b>	<b>RSRZ</b>
1	A	165	GLU	3.5
1	C	17	LYS	3.5
1	I	368	VAL	3.4
1	I	63	PRO	3.4
1	C	28	CYS	3.4
1	A	147	ILE	3.4
1	K	297	ALA	3.4
4	H	23	ALA	3.4
2	F	11	ILE	3.4
2	D	75	LEU	3.4
2	E	174	ARG	3.4
2	L	29	TYR	3.4
4	H	25	SER	3.4
1	C	36	VAL	3.4
2	E	375	HIS	3.4
2	E	122	VAL	3.4
2	D	278	PRO	3.4
1	K	163	ALA	3.4
2	D	29	TYR	3.4
1	C	151	PRO	3.3
1	I	1	MET	3.3
1	K	387	PRO	3.3
1	I	371	LEU	3.3
2	M	362	MET	3.3
1	I	173	VAL	3.3
4	H	75	ALA	3.3
1	C	345	PRO	3.3
2	N	429	ASN	3.3
1	I	55	THR	3.3
2	M	80	ALA	3.3
1	A	14	VAL	3.3
2	F	224	ALA	3.3
2	F	301	VAL	3.3
2	N	26	ASP	3.3
4	H	29	ALA	3.3
1	K	509	MET	3.2
1	K	434	ALA	3.2
1	C	123	VAL	3.2
1	C	46	THR	3.2
1	A	347	GLU	3.2
2	D	371	THR	3.2
2	L	52	GLU	3.2

*Continued on next page...*

*Continued from previous page...*

<b>Mol</b>	<b>Chain</b>	<b>Res</b>	<b>Type</b>	<b>RSRZ</b>
1	C	175	LEU	3.2
1	K	192	ALA	3.2
2	E	21	VAL	3.2
1	B	45	ASP	3.2
1	K	201	PRO	3.2
2	N	85	SER	3.2
2	M	86	LYS	3.2
2	N	219	LEU	3.2
2	L	19	LEU	3.1
2	L	28	ALA	3.1
1	B	387	PRO	3.1
1	K	290	ASN	3.1
1	K	469	GLN	3.1
1	I	424	TRP	3.1
1	I	31	GLY	3.1
2	L	303	GLY	3.1
1	B	59	LYS	3.1
2	F	173	VAL	3.1
2	L	300	VAL	3.1
2	N	147	GLY	3.1
1	C	321	ALA	3.1
1	K	109	HIS	3.1
2	N	123	ALA	3.1
2	M	359	SER	3.1
1	I	170	GLU	3.1
1	C	4	GLY	3.1
1	K	552	ARG	3.1
1	I	364	ARG	3.1
1	K	173	VAL	3.0
1	C	117	TRP	3.0
1	I	147	ILE	3.0
2	N	29	TYR	3.0
1	A	376	GLY	3.0
1	K	553	TYR	3.0
2	L	298	ALA	3.0
1	J	474	ASP	3.0
2	M	168	ALA	3.0
1	A	507	CYS	3.0
2	E	362	MET	3.0
2	E	374	ASP	3.0
1	C	86	GLY	3.0
1	K	181	LEU	3.0

*Continued on next page...*

*Continued from previous page...*

<b>Mol</b>	<b>Chain</b>	<b>Res</b>	<b>Type</b>	<b>RSRZ</b>
1	K	196	GLN	3.0
1	C	73	VAL	3.0
1	I	159	GLU	3.0
1	C	10	ALA	3.0
1	I	68	GLY	2.9
2	N	119	LEU	2.9
1	I	119	TRP	2.9
1	J	478	ASP	2.9
2	N	454	ILE	2.9
1	A	219	ALA	2.9
1	K	174	VAL	2.9
2	D	23	ASN	2.9
1	K	394	PRO	2.9
1	I	233	GLY	2.9
1	I	118	ALA	2.9
2	D	69	ALA	2.9
1	K	82	GLY	2.9
1	I	48	PHE	2.9
2	N	82	LEU	2.9
1	C	502	GLU	2.9
1	I	47	ALA	2.9
2	F	64	THR	2.9
1	I	145	HIS	2.9
1	C	223	THR	2.8
2	M	361	LEU	2.8
2	F	91	ARG	2.8
2	N	419	GLU	2.8
1	K	172	VAL	2.8
1	K	388	GLY	2.8
2	N	350	PRO	2.8
2	M	383	TYR	2.8
4	P	69	PRO	2.8
1	I	223	THR	2.8
2	L	34	ASP	2.8
1	C	378	VAL	2.8
1	K	114	GLU	2.8
2	N	175	PRO	2.8
1	B	112	ASP	2.8
1	C	2	ILE	2.8
2	E	307	SER	2.8
2	F	429	ASN	2.8
2	N	168	ALA	2.8

*Continued on next page...*

*Continued from previous page...*

<b>Mol</b>	<b>Chain</b>	<b>Res</b>	<b>Type</b>	<b>RSRZ</b>
1	K	66	SER	2.8
2	N	79	VAL	2.8
1	J	388	GLY	2.8
1	I	22	ALA	2.8
2	L	55	ALA	2.7
2	F	156	SER	2.7
2	F	188	ALA	2.7
2	F	347	GLY	2.7
2	L	97	GLY	2.7
1	K	43	ASP	2.7
2	L	215	SER	2.7
1	A	167	THR	2.7
1	I	56	SER	2.7
1	A	436	ASP	2.7
2	N	174	ARG	2.7
2	F	242	ALA	2.7
1	C	367	LYS	2.7
2	F	216	ARG	2.7
2	M	28	ALA	2.7
4	P	103	LYS	2.7
2	M	426	GLY	2.7
1	A	85	ASP	2.7
1	K	325	ASP	2.7
1	K	352	PRO	2.7
2	F	79	VAL	2.7
1	I	559	PHE	2.7
1	K	435	LEU	2.7
1	C	293	ASN	2.7
2	N	298	ALA	2.7
2	L	140	VAL	2.7
1	C	180	GLU	2.7
1	C	319	SER	2.7
2	D	77	GLU	2.7
1	I	425	ASN	2.7
1	A	471	VAL	2.7
1	A	218	VAL	2.6
2	N	17	PRO	2.6
1	K	227	PRO	2.6
1	K	11	GLY	2.6
1	K	142	GLY	2.6
2	D	45	GLY	2.6
2	F	83	GLY	2.6

*Continued on next page...*

*Continued from previous page...*

<b>Mol</b>	<b>Chain</b>	<b>Res</b>	<b>Type</b>	<b>RSRZ</b>
1	I	219	ALA	2.6
1	I	179	THR	2.6
2	M	117	LEU	2.6
1	C	222	GLY	2.6
1	K	203	THR	2.6
2	N	86	LYS	2.6
2	L	278	PRO	2.6
1	A	164	GLY	2.6
2	D	21	VAL	2.5
2	D	301	VAL	2.5
2	D	80	ALA	2.5
2	M	365	GLY	2.5
2	E	69	ALA	2.5
1	A	174	VAL	2.5
2	L	36	LYS	2.5
2	F	300	VAL	2.5
1	A	170	GLU	2.5
2	F	34	ASP	2.5
1	I	472	GLY	2.5
2	M	21	VAL	2.5
1	I	136	GLY	2.5
1	K	395	VAL	2.5
1	A	575	LYS	2.5
2	N	370	LYS	2.5
2	N	432	ILE	2.5
2	D	103	LEU	2.5
1	I	376	GLY	2.5
2	F	123	ALA	2.5
1	I	83	ILE	2.5
2	M	439	ALA	2.5
1	A	29	LYS	2.4
1	B	12	PRO	2.4
1	B	499	ALA	2.4
1	C	169	GLU	2.4
1	K	64	VAL	2.4
2	N	78	ASP	2.4
1	A	30	VAL	2.4
1	A	135	LEU	2.4
1	K	470	LEU	2.4
2	M	408	ASP	2.4
2	N	65	GLY	2.4
4	P	78	LYS	2.4

*Continued on next page...*



*Continued from previous page...*

<b>Mol</b>	<b>Chain</b>	<b>Res</b>	<b>Type</b>	<b>RSRZ</b>
1	I	57	GLY	2.4
2	F	80	ALA	2.4
2	N	75	LEU	2.4
2	F	74	SER	2.4
1	K	132	GLY	2.4
2	E	85	SER	2.4
2	M	402	ASP	2.4
1	K	433	SER	2.4
2	F	243	GLU	2.4
1	C	139	PRO	2.4
1	A	59	LYS	2.4
1	I	558	GLU	2.4
1	A	78	GLY	2.4
2	N	340	SER	2.4
1	I	201	PRO	2.4
1	I	33	GLU	2.4
2	L	53	GLU	2.4
2	L	371	THR	2.4
2	N	339	LEU	2.4
1	K	549	GLY	2.4
2	M	307	SER	2.4
2	N	148	GLN	2.4
2	F	366	VAL	2.4
1	C	197	ARG	2.4
2	E	86	LYS	2.4
1	K	191	ARG	2.4
2	E	88	MET	2.4
2	L	346	LYS	2.4
2	F	119	LEU	2.3
1	K	575	LYS	2.3
1	A	403	VAL	2.3
1	B	58	LEU	2.3
2	N	81	ARG	2.3
1	I	566	ALA	2.3
2	D	34	ASP	2.3
1	B	479	ALA	2.3
1	B	551	ALA	2.3
2	E	29	TYR	2.3
2	D	131	ILE	2.3
2	F	88	MET	2.3
1	I	576	ALA	2.3
4	P	84	HIS	2.3

*Continued on next page...*

*Continued from previous page...*

<b>Mol</b>	<b>Chain</b>	<b>Res</b>	<b>Type</b>	<b>RSRZ</b>
1	K	416	ARG	2.3
2	F	154	SER	2.3
2	M	435	SER	2.3
2	M	432	ILE	2.3
1	C	127	ASP	2.3
1	K	271	GLU	2.3
2	D	118	PRO	2.3
2	D	101	ASP	2.3
1	K	273	THR	2.3
2	F	63	THR	2.3
4	H	30	GLN	2.3
2	D	66	LEU	2.3
2	M	120	ASN	2.3
1	C	72	ALA	2.3
1	J	57	GLY	2.3
1	C	188	PRO	2.3
2	F	17	PRO	2.3
2	L	51	SER	2.3
1	B	471	VAL	2.3
1	K	313	PHE	2.3
1	K	417	ARG	2.3
1	A	20	LEU	2.2
1	A	180	GLU	2.2
2	M	83	GLY	2.2
1	K	351	PRO	2.2
2	E	363	ASN	2.2
1	I	248	ASP	2.2
1	I	110	ALA	2.2
1	C	166	TYR	2.2
1	K	169	GLU	2.2
1	A	74	GLU	2.2
4	P	64	ARG	2.2
1	C	360	ALA	2.2
1	I	91	LEU	2.2
1	K	349	GLY	2.2
2	E	306	GLY	2.2
2	D	235	PRO	2.2
2	L	24	ALA	2.2
2	E	364	ASN	2.2
2	M	303	GLY	2.2
1	A	183	MET	2.2
1	I	423	ASN	2.2

*Continued on next page...*

*Continued from previous page...*

<b>Mol</b>	<b>Chain</b>	<b>Res</b>	<b>Type</b>	<b>RSRZ</b>
1	A	560	PRO	2.2
1	I	163	ALA	2.2
2	E	55	ALA	2.2
2	N	9	THR	2.2
1	I	44	GLY	2.2
1	K	179	THR	2.2
2	E	70	THR	2.2
2	F	168	ALA	2.2
1	I	536	ILE	2.2
2	N	421	PHE	2.2
1	J	23	ARG	2.2
1	A	112	ASP	2.2
2	F	187	PHE	2.2
2	N	220	PHE	2.2
1	C	192	ALA	2.2
2	F	294	ILE	2.2
2	N	287	MET	2.2
1	A	140	GLU	2.2
1	C	43	ASP	2.2
1	J	58	LEU	2.2
1	J	494	PHE	2.2
2	N	243	GLU	2.2
2	L	25	LYS	2.2
2	L	38	GLY	2.1
2	E	104	PRO	2.1
4	H	66	ARG	2.1
1	B	267	VAL	2.1
2	D	119	LEU	2.1
2	F	87	GLU	2.1
1	A	44	GLY	2.1
1	B	552	ARG	2.1
1	C	292	SER	2.1
1	I	297	ALA	2.1
4	P	67	ASP	2.1
2	D	277	ILE	2.1
2	N	302	GLU	2.1
1	K	240	SER	2.1
1	B	494	PHE	2.1
1	C	26	ASP	2.1
1	I	174	VAL	2.1
2	M	184	GLU	2.1
2	N	76	VAL	2.1

*Continued on next page...*

*Continued from previous page...*

<b>Mol</b>	<b>Chain</b>	<b>Res</b>	<b>Type</b>	<b>RSRZ</b>
2	E	49	GLU	2.1
2	L	401	GLU	2.1
1	A	120	THR	2.1
1	B	270	PRO	2.1
1	I	138	VAL	2.1
1	C	170	GLU	2.1
1	C	388	GLY	2.1
1	I	111	LEU	2.1
1	I	373	GLY	2.1
1	B	110	ALA	2.1
1	C	154	ARG	2.1
2	D	104	PRO	2.1
1	K	87	ILE	2.1
2	F	96	ILE	2.1
1	I	316	GLN	2.1
1	A	60	VAL	2.1
2	D	76	VAL	2.1
1	A	88	GLN	2.1
1	J	387	PRO	2.1
2	F	27	LEU	2.1
2	N	297	ARG	2.1
2	N	411	TYR	2.1
2	N	157	GLY	2.1
2	D	427	GLN	2.1
2	F	332	ILE	2.1
2	D	24	ALA	2.1
1	B	367	LYS	2.1
1	A	117	TRP	2.1
2	N	120	ASN	2.1
2	E	326	PRO	2.1
1	I	224	ALA	2.1
2	N	117	LEU	2.1
1	A	553	TYR	2.1
1	K	432	THR	2.1
1	B	9	ILE	2.1
1	C	275	PRO	2.0
1	K	350	TYR	2.0
2	F	296	GLU	2.0
2	M	363	ASN	2.0
1	I	171	PRO	2.0
2	N	278	PRO	2.0
1	A	108	VAL	2.0

*Continued on next page...*

*Continued from previous page...*

Mol	Chain	Res	Type	RSRZ
1	J	2	ILE	2.0
2	N	169	ARG	2.0
1	B	11	GLY	2.0
1	K	381	VAL	2.0
1	B	278	GLY	2.0
1	I	366	GLY	2.0
2	E	165	ALA	2.0
2	E	136	SER	2.0
3	O	162	ASN	2.0
1	C	74	GLU	2.0
1	K	180	GLU	2.0
2	E	83	GLY	2.0
2	E	188	ALA	2.0
1	I	551	ALA	2.0

## 6.2 Non-standard residues in protein, DNA, RNA chains [i](#)

There are no non-standard protein/DNA/RNA residues in this entry.

## 6.3 Carbohydrates [i](#)

There are no monosaccharides in this entry.

## 6.4 Ligands [i](#)

There are no ligands in this entry.

## 6.5 Other polymers [i](#)

There are no such residues in this entry.