



Full wwPDB X-ray Structure Validation Report ⓘ

Oct 31, 2023 – 05:57 PM JST

PDB ID : 5GRB
Title : Crystal structure of 2C helicase from enterovirus 71 (EV71) bound with ATPgammaS
Authors : Guan, H.X.; Tian, J.; Qin, B.; Wojdyla, J.; Wang, M.T.; Cui, S.
Deposited on : 2016-08-09
Resolution : 2.80 Å(reported)

This is a Full wwPDB X-ray Structure Validation Report for a publicly released PDB entry.

We welcome your comments at validation@mail.wwpdb.org

A user guide is available at

<https://www.wwpdb.org/validation/2017/XrayValidationReportHelp>

with specific help available everywhere you see the ⓘ symbol.

The types of validation reports are described at

<http://www.wwpdb.org/validation/2017/FAQs#types>.

The following versions of software and data (see [references ⓘ](#)) were used in the production of this report:

MolProbity : 4.02b-467
Mogul : 1.8.5 (274361), CSD as541be (2020)
Xtriage (Phenix) : 1.13
EDS : 2.36
buster-report : 1.1.7 (2018)
Percentile statistics : 20191225.v01 (using entries in the PDB archive December 25th 2019)
Refmac : 5.8.0158
CCP4 : 7.0.044 (Gargrove)
Ideal geometry (proteins) : Engh & Huber (2001)
Ideal geometry (DNA, RNA) : Parkinson et al. (1996)
Validation Pipeline (wwPDB-VP) : 2.36

1 Overall quality at a glance

The following experimental techniques were used to determine the structure:

X-RAY DIFFRACTION

The reported resolution of this entry is 2.80 Å.

Percentile scores (ranging between 0-100) for global validation metrics of the entry are shown in the following graphic. The table shows the number of entries on which the scores are based.

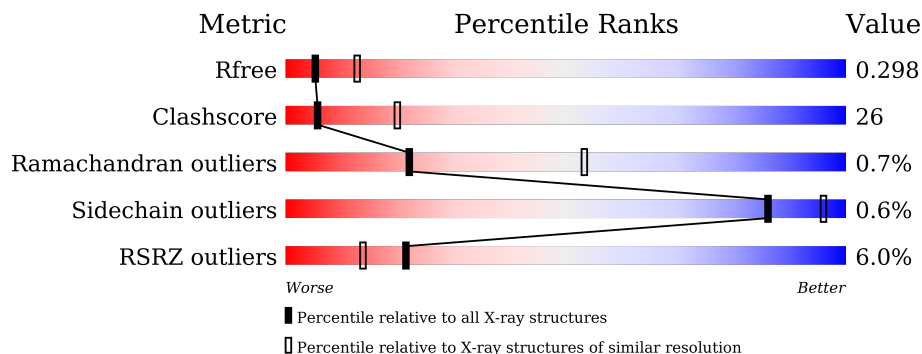

Metric	Whole archive (#Entries)	Similar resolution (#Entries, resolution range(Å))
R_{free}	130704	3140 (2.80-2.80)
Clashscore	141614	3569 (2.80-2.80)
Ramachandran outliers	138981	3498 (2.80-2.80)
Sidechain outliers	138945	3500 (2.80-2.80)
RSRZ outliers	127900	3078 (2.80-2.80)

The table below summarises the geometric issues observed across the polymeric chains and their fit to the electron density. The red, orange, yellow and green segments of the lower bar indicate the fraction of residues that contain outliers for ≥ 3 , 2, 1 and 0 types of geometric quality criteria respectively. A grey segment represents the fraction of residues that are not modelled. The numeric value for each fraction is indicated below the corresponding segment, with a dot representing fractions $\leq 5\%$. The upper red bar (where present) indicates the fraction of residues that have poor fit to the electron density. The numeric value is given above the bar.

Mol	Chain	Length	Quality of chain
1	A	214	 5% 59% 34% 5%
1	B	214	 2% 64% 34% 2%
1	C	214	 5% 52% 39% 7%
1	D	214	 5% 58% 36% 5%
1	E	214	 10% 57% 39% 2%
1	F	214	 12% 54% 42% 2%

2 Entry composition [i](#)

There are 4 unique types of molecules in this entry. The entry contains 9755 atoms, of which 0 are hydrogens and 0 are deuteriums.

In the tables below, the ZeroOcc column contains the number of atoms modelled with zero occupancy, the AltConf column contains the number of residues with at least one atom in alternate conformation and the Trace column contains the number of residues modelled with at most 2 atoms.

- Molecule 1 is a protein called EV71 2C ATPase.

Mol	Chain	Residues	Atoms					ZeroOcc	AltConf	Trace
			Total	C	N	O	S			
1	A	211	Total 1620	C 1010	N 283	O 315	S 12	0	0	0
1	B	212	Total 1629	C 1016	N 285	O 316	S 12	0	0	0
1	C	199	Total 1532	C 955	N 269	O 296	S 12	0	0	0
1	D	203	Total 1568	C 978	N 277	O 301	S 12	0	0	0
1	E	208	Total 1601	C 997	N 281	O 311	S 12	0	0	0
1	F	208	Total 1601	C 997	N 281	O 311	S 12	0	0	0

- Molecule 2 is PHOSPHOTHIOPHOSPHORIC ACID-ADENYLATE ESTER (three-letter code: AGS) (formula: $C_{10}H_{16}N_5O_{12}P_3S$).

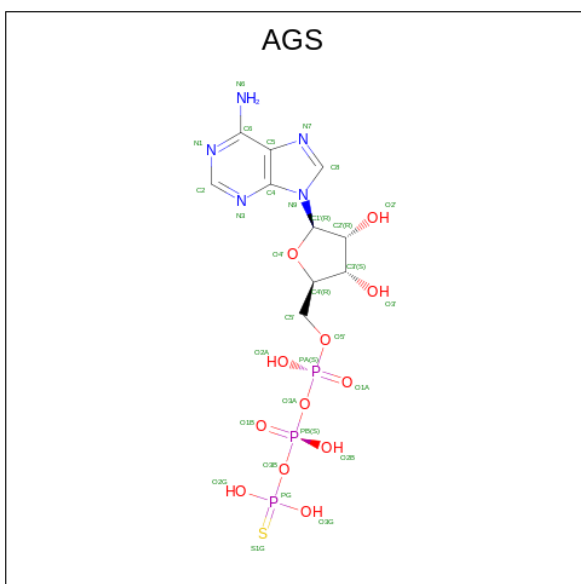

Mol	Chain	Residues	Atoms					ZeroOcc	AltConf	
2	A	1	Total	C	N	O	P	S	0	0
			31	10	5	12	3	1		
2	B	1	Total	C	N	O	P	S	0	0
			31	10	5	12	3	1		
2	C	1	Total	C	N	O	P	S	0	0
			31	10	5	12	3	1		
2	D	1	Total	C	N	O	P	S	0	0
			31	10	5	12	3	1		
2	E	1	Total	C	N	O	P	S	0	0
			31	10	5	12	3	1		
2	F	1	Total	C	N	O	P	S	0	0
			31	10	5	12	3	1		

- Molecule 3 is ZINC ION (three-letter code: ZN) (formula: Zn).

Mol	Chain	Residues	Atoms		ZeroOcc	AltConf
3	A	1	Total	Zn	0	0
			1	1		
3	B	1	Total	Zn	0	0
			1	1		
3	C	1	Total	Zn	0	0
			1	1		
3	D	1	Total	Zn	0	0
			1	1		
3	E	1	Total	Zn	0	0
			1	1		
3	F	1	Total	Zn	0	0
			1	1		

- Molecule 4 is water.

Mol	Chain	Residues	Atoms		ZeroOcc	AltConf
4	A	2	Total	O	0	0
			2	2		
4	B	2	Total	O	0	0
			2	2		
4	C	4	Total	O	0	0
			4	4		
4	D	4	Total	O	0	0
			4	4		

3 Residue-property plots [i](#)

These plots are drawn for all protein, RNA, DNA and oligosaccharide chains in the entry. The first graphic for a chain summarises the proportions of the various outlier classes displayed in the second graphic. The second graphic shows the sequence view annotated by issues in geometry and electron density. Residues are color-coded according to the number of geometric quality criteria for which they contain at least one outlier: green = 0, yellow = 1, orange = 2 and red = 3 or more. A red dot above a residue indicates a poor fit to the electron density ($RSRZ > 2$). Stretches of 2 or more consecutive residues without any outlier are shown as a green connector. Residues present in the sample, but not in the model, are shown in grey.

- Molecule 1: EV71 2C ATPase

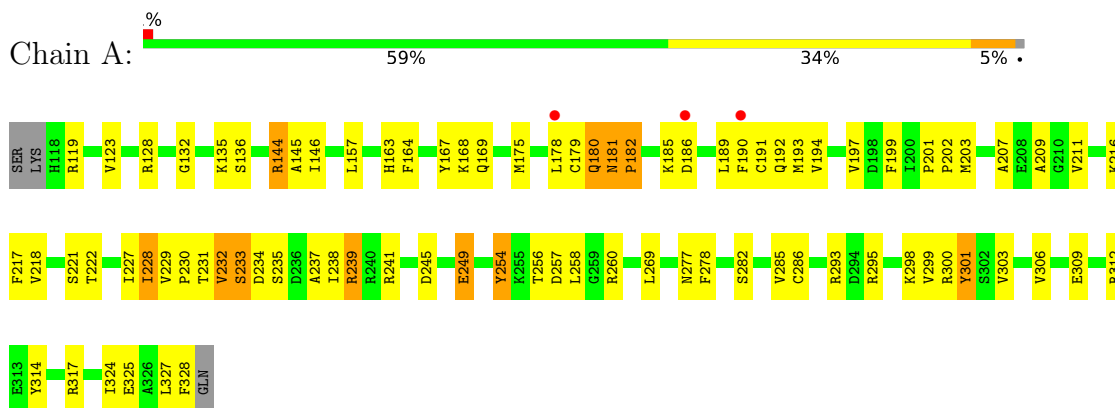

- Molecule 1: EV71 2C ATPase

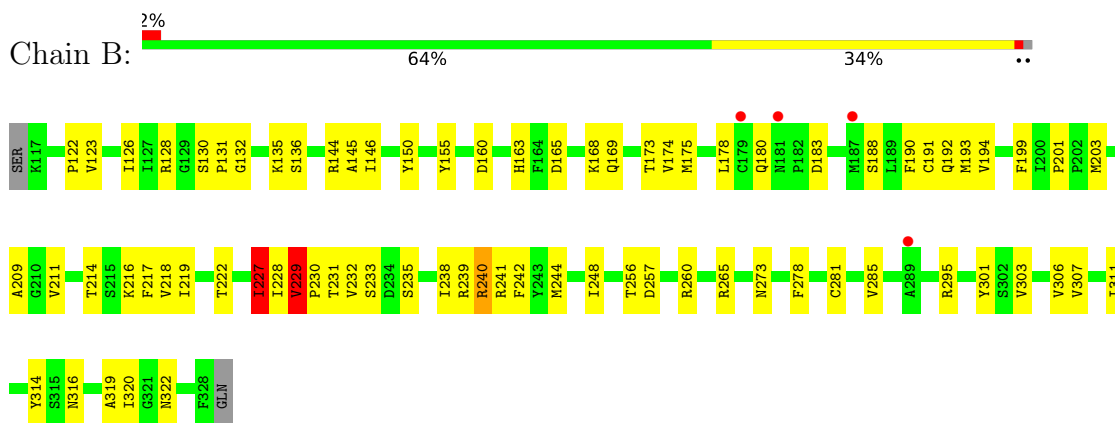

- Molecule 1: EV71 2C ATPase

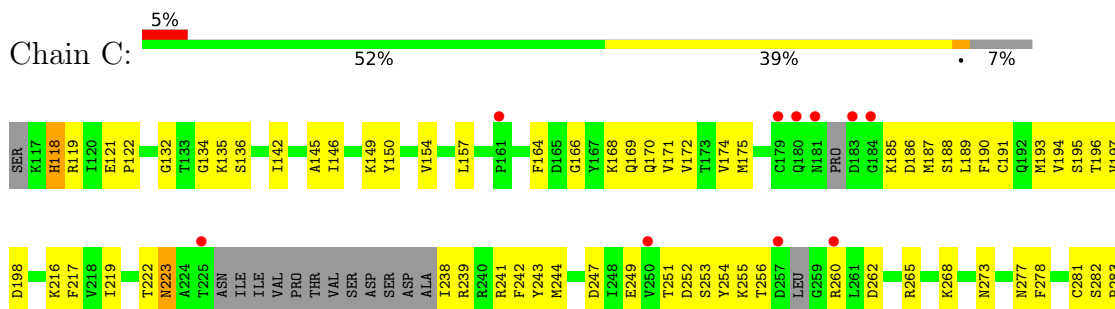



● Molecule 1: EV71 2C ATPase

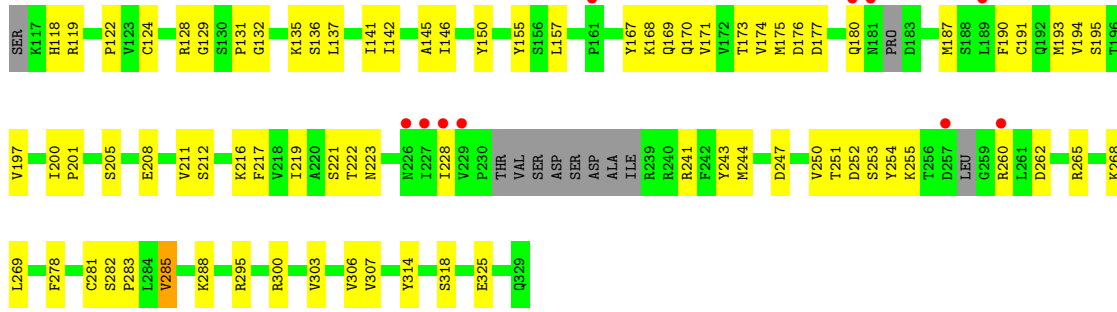

● Molecule 1: EV71 2C ATPase

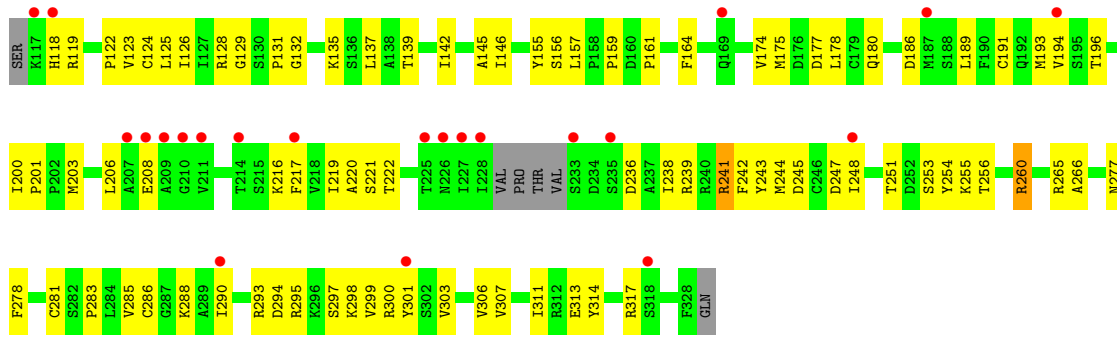

● Molecule 1: EV71 2C ATPase

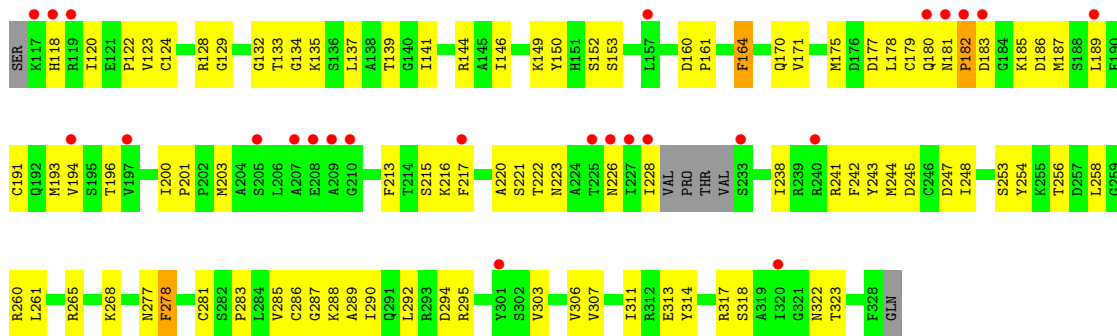

4 Data and refinement statistics i

Property	Value	Source
Space group	P 1 21 1	Depositor
Cell constants a, b, c, α , β , γ	73.67Å 54.91Å 163.10Å 90.00° 89.98° 90.00°	Depositor
Resolution (Å)	45.55 – 2.80 45.55 – 2.81	Depositor EDS
% Data completeness (in resolution range)	95.2 (45.55-2.80) 93.4 (45.55-2.81)	Depositor EDS
R_{merge}	(Not available)	Depositor
R_{sym}	0.05	Depositor
$\langle I/\sigma(I) \rangle$ ¹	1.15 (at 2.81Å)	Xtrriage
Refinement program	PHENIX (1.10.1_2155: ???)	Depositor
R, R_{free}	0.245 , 0.296 0.246 , 0.298	Depositor DCC
R_{free} test set	1520 reflections (5.03%)	wwPDB-VP
Wilson B-factor (Å ²)	76.6	Xtrriage
Anisotropy	0.454	Xtrriage
Bulk solvent k_{sol} (e/Å ³), B_{sol} (Å ²)	0.28 , 32.3	EDS
L-test for twinning ²	$\langle L \rangle = 0.49$, $\langle L^2 \rangle = 0.32$	Xtrriage
Estimated twinning fraction	0.468 for h,-k,-l	Xtrriage
F_o, F_c correlation	0.94	EDS
Total number of atoms	9755	wwPDB-VP
Average B, all atoms (Å ²)	82.0	wwPDB-VP

Xtrriage's analysis on translational NCS is as follows: *The largest off-origin peak in the Patterson function is 5.11% of the height of the origin peak. No significant pseudotranslation is detected.*

¹Intensities estimated from amplitudes.

²Theoretical values of $\langle |L| \rangle$, $\langle L^2 \rangle$ for acentric reflections are 0.5, 0.333 respectively for untwinned datasets, and 0.375, 0.2 for perfectly twinned datasets.

5 Model quality [i](#)

5.1 Standard geometry [i](#)

Bond lengths and bond angles in the following residue types are not validated in this section: ZN, AGS

The Z score for a bond length (or angle) is the number of standard deviations the observed value is removed from the expected value. A bond length (or angle) with $|Z| > 5$ is considered an outlier worth inspection. RMSZ is the root-mean-square of all Z scores of the bond lengths (or angles).

Mol	Chain	Bond lengths		Bond angles	
		RMSZ	# Z >5	RMSZ	# Z >5
1	A	0.47	1/1647 (0.1%)	0.87	5/2230 (0.2%)
1	B	0.51	1/1656 (0.1%)	0.80	5/2241 (0.2%)
1	C	0.46	1/1554 (0.1%)	0.71	0/2094
1	D	0.40	0/1591	0.65	1/2145 (0.0%)
1	E	0.41	0/1626	0.80	4/2196 (0.2%)
1	F	0.40	0/1626	0.74	0/2196
All	All	0.44	3/9700 (0.0%)	0.77	15/13102 (0.1%)

Chiral center outliers are detected by calculating the chiral volume of a chiral center and verifying if the center is modelled as a planar moiety or with the opposite hand. A planarity outlier is detected by checking planarity of atoms in a peptide group, atoms in a mainchain group or atoms of a sidechain that are expected to be planar.

Mol	Chain	#Chirality outliers	#Planarity outliers
1	A	0	1
1	B	0	1
1	C	0	2
1	D	0	1
1	F	0	1
All	All	0	6

All (3) bond length outliers are listed below:

Mol	Chain	Res	Type	Atoms	Z	Observed(Å)	Ideal(Å)
1	B	240	ARG	CB-CG	7.19	1.72	1.52
1	C	286	CYS	CB-SG	-5.90	1.72	1.81
1	A	286	CYS	CB-SG	-5.26	1.73	1.81

All (15) bond angle outliers are listed below:

Mol	Chain	Res	Type	Atoms	Z	Observed(°)	Ideal(°)
1	E	260	ARG	NE-CZ-NH1	8.19	124.39	120.30
1	E	241	ARG	NE-CZ-NH1	-7.78	116.41	120.30
1	E	260	ARG	NE-CZ-NH2	-7.57	116.52	120.30
1	E	260	ARG	CB-CG-CD	-7.28	92.68	111.60
1	A	180	GLN	C-N-CA	6.55	138.08	121.70
1	B	240	ARG	CD-NE-CZ	-6.28	114.81	123.60
1	B	240	ARG	NE-CZ-NH1	-6.21	117.19	120.30
1	A	239	ARG	NE-CZ-NH1	-6.03	117.28	120.30
1	A	233	SER	N-CA-C	-5.55	96.01	111.00
1	B	227	ILE	C-N-CA	5.49	135.43	121.70
1	B	240	ARG	N-CA-CB	5.48	120.47	110.60
1	D	285	VAL	CG1-CB-CG2	5.18	119.19	110.90
1	B	240	ARG	CA-CB-CG	-5.14	102.09	113.40
1	A	144	ARG	NE-CZ-NH1	-5.13	117.73	120.30
1	A	249	GLU	CA-CB-CG	-5.01	102.39	113.40

There are no chirality outliers.

All (6) planarity outliers are listed below:

Mol	Chain	Res	Type	Group
1	A	181	ASN	Peptide
1	B	227	ILE	Peptide
1	C	118	HIS	Peptide
1	C	223	ASN	Peptide
1	D	223	ASN	Peptide
1	F	242	PHE	Peptide

5.2 Too-close contacts [\(i\)](#)

In the following table, the Non-H and H(model) columns list the number of non-hydrogen atoms and hydrogen atoms in the chain respectively. The H(added) column lists the number of hydrogen atoms added and optimized by MolProbity. The Clashes column lists the number of clashes within the asymmetric unit, whereas Symm-Clashes lists symmetry-related clashes.

Mol	Chain	Non-H	H(model)	H(added)	Clashes	Symm-Clashes
1	A	1620	0	1616	102	0
1	B	1629	0	1628	67	1
1	C	1532	0	1522	73	0
1	D	1568	0	1565	75	1
1	E	1601	0	1595	96	0
1	F	1601	0	1595	84	0
2	A	31	0	12	6	0

Continued on next page...

Continued from previous page...

Mol	Chain	Non-H	H(model)	H(added)	Clashes	Symm-Clashes
2	B	31	0	12	3	0
2	C	31	0	12	4	0
2	D	31	0	12	4	0
2	E	31	0	12	3	0
2	F	31	0	12	3	0
3	A	1	0	0	0	0
3	B	1	0	0	0	0
3	C	1	0	0	1	0
3	D	1	0	0	0	0
3	E	1	0	0	0	0
3	F	1	0	0	0	0
4	A	2	0	0	0	0
4	B	2	0	0	1	0
4	C	4	0	0	3	0
4	D	4	0	0	5	0
All	All	9755	0	9593	493	1

The all-atom clashscore is defined as the number of clashes found per 1000 atoms (including hydrogen atoms). The all-atom clashscore for this structure is 26.

All (493) close contacts within the same asymmetric unit are listed below, sorted by their clash magnitude.

Atom-1	Atom-2	Interatomic distance (Å)	Clash overlap (Å)
1:A:229:VAL:HG11	1:A:238:ILE:HG12	1.41	1.02
1:B:227:ILE:HA	1:B:228:ILE:HG22	1.42	1.01
1:A:194:VAL:O	1:A:241:ARG:NH1	1.98	0.95
1:A:235:SER:HB3	1:A:239:ARG:HH12	1.30	0.95
1:A:119:ARG:NH1	1:A:197:VAL:O	2.02	0.92
1:A:135:LYS:NZ	1:A:222:THR:O	2.03	0.89
1:B:194:VAL:O	1:B:241:ARG:NH1	2.09	0.86
1:D:265:ARG:HA	1:D:268:LYS:HE3	1.58	0.86
1:A:232:VAL:O	1:A:233:SER:OG	1.94	0.85
1:A:249:GLU:OE1	1:A:293:ARG:NH1	2.10	0.85
1:A:132:GLY:HA3	1:A:260:ARG:HD2	1.57	0.84
1:A:132:GLY:N	2:A:401:AGS:O2A	2.11	0.82
1:C:191:CYS:SG	1:C:241:ARG:NH1	2.52	0.82
1:A:191:CYS:SG	1:A:241:ARG:NH2	2.53	0.82
1:C:309:GLU:OE2	1:C:312:ARG:NH2	2.13	0.82
1:D:176:ASP:OD1	1:D:221:SER:OG	1.98	0.82
1:F:261:LEU:HD22	1:F:290:ILE:HD11	1.62	0.81
1:A:230:PRO:O	1:A:232:VAL:HB	1.82	0.80

Continued on next page...

Continued from previous page...

Atom-1	Atom-2	Interatomic distance (Å)	Clash overlap (Å)
1:A:233:SER:HB2	1:A:234:ASP:HA	1.63	0.80
1:E:238:ILE:HA	1:E:241:ARG:HH21	1.46	0.79
1:A:235:SER:HB3	1:A:239:ARG:NH1	1.97	0.79
1:B:146:ILE:HD13	1:B:217:PHE:HD2	1.49	0.78
1:C:253:SER:O	1:C:265:ARG:NH2	2.15	0.78
1:C:119:ARG:NH2	1:C:193:MET:O	2.18	0.78
1:E:146:ILE:HD13	1:E:217:PHE:HD2	1.49	0.78
1:F:254:TYR:OH	1:F:288:LYS:NZ	2.17	0.77
1:A:285:VAL:HA	1:A:303:VAL:HG22	1.68	0.76
1:E:303:VAL:HA	1:E:306:VAL:HG22	1.66	0.76
1:F:179:CYS:SG	1:F:228:ILE:HB	2.27	0.75
1:B:229:VAL:HG21	1:B:238:ILE:HG13	1.69	0.75
1:F:118:HIS:HB2	1:F:196:THR:O	1.86	0.75
1:A:146:ILE:HD13	1:A:217:PHE:HD2	1.52	0.74
1:D:135:LYS:HG2	2:D:401:AGS:S1G	2.26	0.74
2:A:401:AGS:O2A	2:A:401:AGS:O2B	2.04	0.74
1:B:150:TYR:HE1	1:B:311:ILE:HD12	1.53	0.74
1:A:232:VAL:HG12	1:A:233:SER:N	2.04	0.73
1:C:149:LYS:HD3	1:C:311:ILE:HD13	1.71	0.73
1:C:166:GLY:N	1:E:236:ASP:OD2	2.22	0.72
1:E:294:ASP:OD2	1:E:297:SER:OG	2.07	0.72
1:A:128:ARG:NH1	1:A:245:ASP:OD1	2.22	0.72
1:A:132:GLY:HA3	1:A:260:ARG:CD	2.19	0.71
1:F:146:ILE:HD13	1:F:217:PHE:HD2	1.53	0.71
1:B:146:ILE:HG21	1:B:217:PHE:CD2	2.26	0.71
1:A:327:LEU:HD13	1:F:278:PHE:HD2	1.57	0.70
1:A:146:ILE:HD13	1:A:217:PHE:CD2	2.26	0.70
1:B:135:LYS:NZ	1:B:222:THR:O	2.25	0.70
1:F:132:GLY:HA3	1:F:260:ARG:HD3	1.73	0.70
1:B:285:VAL:HA	1:B:303:VAL:HG22	1.72	0.69
1:D:129:GLY:O	1:D:135:LYS:NZ	2.24	0.69
1:C:265:ARG:HG3	1:C:268:LYS:HZ1	1.57	0.69
1:C:293:ARG:HH21	1:C:300:ARG:HG2	1.57	0.69
1:A:128:ARG:HH21	1:A:228:ILE:HG21	1.56	0.69
1:D:146:ILE:HD13	1:D:217:PHE:HD2	1.58	0.69
1:A:325:GLU:OE1	1:F:144:ARG:NH1	2.27	0.68
1:E:132:GLY:HA3	1:E:260:ARG:HH11	1.58	0.68
1:E:285:VAL:HA	1:E:303:VAL:HG22	1.75	0.68
1:A:135:LYS:HE2	2:A:401:AGS:O1A	1.94	0.68
1:B:146:ILE:HD13	1:B:217:PHE:CD2	2.29	0.68
1:D:146:ILE:HG21	1:D:217:PHE:CD2	2.28	0.68

Continued on next page...

Continued from previous page...

Atom-1	Atom-2	Interatomic distance (Å)	Clash overlap (Å)
1:D:119:ARG:NH2	1:D:193:MET:O	2.27	0.68
1:F:313:GLU:O	1:F:317:ARG:HG2	1.94	0.68
1:C:146:ILE:HG21	1:C:217:PHE:CD2	2.28	0.68
1:C:286:CYS:SG	3:C:402:ZN:ZN	1.84	0.67
1:A:229:VAL:CG1	1:A:238:ILE:HG12	2.23	0.67
1:E:132:GLY:HA3	1:E:260:ARG:NH1	2.09	0.67
1:C:142:ILE:HG23	1:C:307:VAL:HG12	1.75	0.67
1:A:233:SER:CB	1:A:234:ASP:HA	2.25	0.67
1:D:251:THR:OG1	4:D:501:HOH:O	2.12	0.67
1:D:168:LYS:HG2	1:D:170:GLN:NE2	2.10	0.66
1:F:303:VAL:HA	1:F:306:VAL:HG12	1.76	0.66
1:A:119:ARG:NH2	1:A:193:MET:O	2.28	0.66
1:E:161:PRO:HD2	1:E:186:ASP:OD1	1.95	0.66
1:A:228:ILE:HG13	1:A:229:VAL:H	1.61	0.66
1:F:146:ILE:HD13	1:F:217:PHE:CD2	2.31	0.66
1:E:243:TYR:CZ	1:E:313:GLU:HG3	2.31	0.66
1:F:122:PRO:HD2	1:F:194:VAL:HA	1.78	0.66
1:B:216:LYS:HD2	1:B:314:TYR:CE2	2.31	0.65
1:C:132:GLY:HA3	1:C:260:ARG:HD3	1.78	0.65
1:B:128:ARG:CZ	1:B:295:ARG:HH12	2.10	0.65
1:D:187:MET:HE1	1:D:228:ILE:O	1.97	0.64
1:A:179:CYS:H	1:A:222:THR:HG22	1.62	0.64
1:A:230:PRO:HG2	1:A:232:VAL:CG2	2.27	0.64
1:B:136:SER:OG	2:B:401:AGS:O2B	2.14	0.64
1:B:265:ARG:NH1	1:C:198:ASP:OD2	2.30	0.64
1:E:238:ILE:HG23	1:E:239:ARG:HG2	1.77	0.64
1:C:265:ARG:HA	1:C:268:LYS:NZ	2.12	0.64
1:D:251:THR:OG1	1:D:288:LYS:O	2.15	0.64
1:F:222:THR:HG22	1:F:223:ASN:H	1.63	0.64
1:F:256:THR:HG22	1:F:260:ARG:N	2.14	0.63
1:D:142:ILE:HG23	1:D:307:VAL:HG12	1.80	0.63
1:E:146:ILE:HD13	1:E:217:PHE:CD2	2.33	0.63
1:B:217:PHE:HE1	1:B:314:TYR:HB2	1.63	0.63
1:A:167:TYR:CZ	1:A:169:GLN:HA	2.34	0.63
1:A:230:PRO:HG2	1:A:232:VAL:HB	1.78	0.63
1:C:256:THR:OG1	1:C:262:ASP:HB2	1.99	0.63
1:F:254:TYR:OH	1:F:268:LYS:NZ	2.22	0.63
1:E:238:ILE:HA	1:E:241:ARG:NH2	2.13	0.62
1:C:122:PRO:HB2	1:C:194:VAL:HG12	1.82	0.62
1:B:122:PRO:HD2	1:B:194:VAL:HA	1.81	0.62
1:E:314:TYR:HA	1:E:317:ARG:HB3	1.80	0.62

Continued on next page...

Continued from previous page...

Atom-1	Atom-2	Interatomic distance (Å)	Clash overlap (Å)
1:F:243:TYR:CZ	1:F:313:GLU:HG3	2.35	0.62
1:D:146:ILE:HD13	1:D:217:PHE:CD2	2.35	0.61
1:E:248:ILE:HD11	1:E:290:ILE:HG23	1.81	0.61
1:A:178:LEU:N	1:A:221:SER:O	2.31	0.61
1:F:285:VAL:HA	1:F:303:VAL:HG22	1.81	0.61
1:A:232:VAL:HG12	1:A:233:SER:H	1.65	0.61
1:B:188:SER:O	1:B:192:GLN:NE2	2.33	0.61
1:B:230:PRO:O	1:B:233:SER:HB2	2.01	0.61
1:C:135:LYS:NZ	1:C:222:THR:O	2.27	0.61
1:F:256:THR:HG22	1:F:260:ARG:H	1.66	0.61
1:F:216:LYS:O	1:F:217:PHE:HD1	1.84	0.61
1:F:253:SER:O	1:F:265:ARG:NH1	2.34	0.60
1:B:169:GLN:OE1	1:B:214:THR:OG1	2.06	0.60
1:F:248:ILE:HD11	1:F:290:ILE:HG23	1.82	0.60
1:A:185:LYS:HG3	1:A:186:ASP:H	1.67	0.60
1:C:217:PHE:HE1	1:C:314:TYR:HB2	1.66	0.60
1:A:128:ARG:HH21	1:A:228:ILE:CG2	2.15	0.60
1:C:253:SER:OG	4:C:501:HOH:O	2.15	0.60
1:D:191:CYS:HB2	4:D:503:HOH:O	2.00	0.60
1:F:149:LYS:HE3	1:F:277:ASN:HD22	1.67	0.59
1:D:187:MET:O	4:D:503:HOH:O	2.16	0.59
1:C:239:ARG:HD3	1:C:242:PHE:HE2	1.67	0.59
1:A:230:PRO:HG2	1:A:232:VAL:HG21	1.85	0.59
1:C:146:ILE:HD13	1:C:217:PHE:HD2	1.68	0.59
1:D:253:SER:O	1:D:265:ARG:NH2	2.33	0.59
1:D:155:TYR:HB3	1:D:173:THR:HG22	1.83	0.59
1:E:126:ILE:HG22	1:E:220:ALA:HB3	1.83	0.59
1:A:128:ARG:HH12	1:A:245:ASP:CG	2.06	0.58
1:C:164:PHE:HE1	1:C:189:LEU:HD21	1.67	0.58
1:E:191:CYS:CB	1:E:241:ARG:HH12	2.16	0.58
2:F:401:AGS:H3'	2:F:401:AGS:O2A	2.03	0.58
1:E:119:ARG:NH2	1:E:193:MET:O	2.36	0.58
1:F:177:ASP:HB3	1:F:180:GLN:OE1	2.02	0.58
1:F:322:ASN:OD1	1:F:323:THR:N	2.37	0.58
1:A:216:LYS:HD2	1:A:314:TYR:CZ	2.39	0.58
1:A:146:ILE:HG21	1:A:217:PHE:CD2	2.38	0.58
1:A:230:PRO:HG2	1:A:232:VAL:CB	2.32	0.58
1:A:233:SER:HB2	1:A:234:ASP:CA	2.31	0.58
1:A:299:VAL:HG23	1:A:301:TYR:HE1	1.69	0.58
1:E:216:LYS:HD3	1:E:314:TYR:HE2	1.68	0.58
1:F:243:TYR:CE2	1:F:313:GLU:HG3	2.38	0.58

Continued on next page...

Continued from previous page...

Atom-1	Atom-2	Interatomic distance (Å)	Clash overlap (Å)
1:E:238:ILE:HG12	1:E:239:ARG:NH1	2.18	0.57
1:A:229:VAL:HG11	1:A:238:ILE:CG1	2.28	0.57
1:A:231:THR:HA	1:A:232:VAL:C	2.24	0.57
1:F:164:PHE:HE1	1:F:189:LEU:HD23	1.69	0.57
1:C:239:ARG:HD3	1:C:242:PHE:CE2	2.40	0.56
1:B:229:VAL:HG13	1:B:230:PRO:O	2.05	0.56
1:C:251:THR:OG1	1:C:288:LYS:O	2.22	0.56
1:E:177:ASP:O	1:E:180:GLN:HB2	2.06	0.56
1:D:252:ASP:HA	1:D:255:LYS:CG	2.35	0.56
1:C:136:SER:OG	2:C:401:AGS:S1G	2.63	0.56
1:E:177:ASP:OD1	2:E:401:AGS:O3G	2.24	0.56
1:D:175:MET:HE1	1:D:190:PHE:CD1	2.41	0.56
1:D:190:PHE:O	1:D:194:VAL:HG22	2.05	0.56
1:D:283:PRO:HB3	1:D:288:LYS:HB2	1.87	0.56
1:F:129:GLY:HA3	1:F:248:ILE:HG22	1.86	0.56
1:B:135:LYS:HG2	1:B:248:ILE:HG21	1.86	0.56
1:B:160:ASP:HB2	1:B:180:GLN:NE2	2.20	0.56
1:B:175:MET:SD	1:B:178:LEU:HD12	2.46	0.56
1:B:216:LYS:HD2	1:B:314:TYR:CZ	2.41	0.56
1:B:230:PRO:HB3	1:B:231:THR:O	2.05	0.56
1:C:150:TYR:HD2	1:C:171:VAL:HG11	1.71	0.56
1:A:327:LEU:HD13	1:F:278:PHE:CD2	2.40	0.56
1:F:171:VAL:HG13	1:F:216:LYS:HB2	1.87	0.56
1:A:123:VAL:HG12	1:A:317:ARG:CZ	2.36	0.56
1:C:190:PHE:CE2	1:C:242:PHE:HE1	2.24	0.56
1:B:217:PHE:CE1	1:B:314:TYR:HB2	2.41	0.55
1:A:216:LYS:C	1:A:217:PHE:HD1	2.09	0.55
1:C:251:THR:OG1	4:C:502:HOH:O	2.18	0.55
1:E:131:PRO:O	1:E:260:ARG:CZ	2.55	0.55
1:B:163:HIS:ND1	1:B:165:ASP:HB2	2.20	0.55
1:B:227:ILE:HA	1:B:228:ILE:CG2	2.29	0.55
1:D:177:ASP:OD2	1:D:180:GLN:NE2	2.40	0.55
1:A:190:PHE:HE1	1:A:218:VAL:HG11	1.71	0.54
1:A:136:SER:OG	2:A:401:AGS:O3G	2.21	0.54
1:F:133:THR:O	1:F:261:LEU:HD23	2.08	0.54
1:F:243:TYR:CD2	1:F:244:MET:HG2	2.42	0.54
1:A:233:SER:CB	1:A:234:ASP:CA	2.85	0.54
1:B:307:VAL:O	1:B:311:ILE:HG12	2.06	0.54
1:E:216:LYS:O	1:E:217:PHE:HD1	1.90	0.54
1:D:155:TYR:HE2	1:D:157:LEU:HD13	1.71	0.54
1:F:222:THR:HG21	1:F:228:ILE:HG21	1.88	0.54

Continued on next page...

Continued from previous page...

Atom-1	Atom-2	Interatomic distance (Å)	Clash overlap (Å)
1:D:131:PRO:HG2	1:D:260:ARG:HH12	1.73	0.54
1:A:230:PRO:C	1:A:232:VAL:HB	2.27	0.54
1:E:124:CYS:HB3	1:E:241:ARG:O	2.07	0.54
1:D:247:ASP:OD1	1:D:295:ARG:NE	2.38	0.53
1:C:249:GLU:OE1	1:C:300:ARG:NH1	2.30	0.53
1:F:178:LEU:HD23	1:F:179:CYS:SG	2.48	0.53
1:B:303:VAL:HA	1:B:306:VAL:HG12	1.90	0.53
1:E:146:ILE:HG21	1:E:217:PHE:CD2	2.44	0.53
1:F:256:THR:HG23	1:F:258:LEU:H	1.74	0.53
1:B:132:GLY:HA3	1:B:260:ARG:HD2	1.90	0.53
1:A:144:ARG:HG2	1:C:328:PHE:HE2	1.73	0.53
1:A:185:LYS:HG3	1:A:186:ASP:N	2.23	0.53
1:B:228:ILE:O	1:B:229:VAL:HG12	2.09	0.53
1:D:187:MET:HB3	4:D:503:HOH:O	2.09	0.53
1:E:156:SER:HA	1:E:174:VAL:HG12	1.91	0.53
1:A:128:ARG:NH2	1:A:228:ILE:HG21	2.24	0.53
1:A:216:LYS:O	1:A:217:PHE:HD1	1.92	0.53
1:C:217:PHE:CE1	1:C:314:TYR:HB2	2.42	0.53
1:B:301:TYR:HD1	4:B:501:HOH:O	1.92	0.52
1:C:249:GLU:CD	1:C:300:ARG:HH12	2.12	0.52
1:E:294:ASP:HB3	1:E:299:VAL:H	1.73	0.52
1:A:228:ILE:HD11	1:A:239:ARG:NE	2.24	0.52
1:C:254:TYR:HA	1:C:265:ARG:NH2	2.24	0.52
1:F:243:TYR:CE2	1:F:244:MET:HG2	2.44	0.52
1:A:303:VAL:HA	1:A:306:VAL:HG12	1.91	0.52
2:A:401:AGS:O3B	2:A:401:AGS:O3'	2.10	0.52
1:E:294:ASP:HB3	1:E:298:LYS:N	2.25	0.52
1:C:157:LEU:HD23	1:C:175:MET:HG2	1.92	0.52
1:D:247:ASP:CG	1:D:295:ARG:HE	2.13	0.52
1:B:235:SER:O	1:B:239:ARG:HG3	2.10	0.52
1:B:230:PRO:HA	1:B:231:THR:HB	1.92	0.52
1:A:201:PRO:HD2	1:A:211:VAL:O	2.10	0.52
1:F:283:PRO:HB2	1:F:289:ALA:HB2	1.92	0.51
1:D:281:CYS:SG	1:D:282:SER:N	2.84	0.51
1:F:191:CYS:HA	1:F:241:ARG:NH1	2.25	0.51
1:A:277:ASN:O	1:A:278:PHE:HD1	1.93	0.51
1:D:128:ARG:HG2	1:D:222:THR:CG2	2.40	0.51
1:A:256:THR:HG22	1:A:260:ARG:O	2.11	0.51
1:D:124:CYS:HG	1:D:190:PHE:HZ	1.59	0.51
1:D:285:VAL:HA	1:D:303:VAL:HB	1.93	0.51
1:E:293:ARG:CD	1:E:300:ARG:HD2	2.41	0.51

Continued on next page...

Continued from previous page...

Atom-1	Atom-2	Interatomic distance (Å)	Clash overlap (Å)
1:F:307:VAL:O	1:F:311:ILE:HG12	2.11	0.51
1:A:178:LEU:HB3	1:A:222:THR:CG2	2.41	0.51
1:B:128:ARG:NH1	1:B:295:ARG:HH12	2.09	0.51
1:C:190:PHE:HE2	1:C:242:PHE:HE1	1.57	0.51
1:D:150:TYR:HD2	1:D:171:VAL:HG11	1.75	0.51
1:F:175:MET:O	1:F:220:ALA:HA	2.11	0.51
1:F:238:ILE:HG23	1:F:241:ARG:NH1	2.25	0.51
1:F:161:PRO:HD2	1:F:186:ASP:OD1	2.11	0.51
1:A:293:ARG:NH2	1:A:300:ARG:NH1	2.58	0.51
1:D:187:MET:HA	1:D:190:PHE:HB3	1.92	0.50
1:E:293:ARG:HD3	1:E:300:ARG:HD2	1.91	0.50
2:C:401:AGS:O1B	2:C:401:AGS:O3G	2.22	0.50
1:F:135:LYS:O	1:F:139:THR:HG23	2.11	0.50
1:A:232:VAL:HG12	1:A:233:SER:O	2.11	0.50
1:C:146:ILE:HD13	1:C:217:PHE:CD2	2.46	0.50
1:E:135:LYS:HE3	1:E:222:THR:O	2.12	0.50
1:D:174:VAL:HA	1:D:219:ILE:O	2.11	0.50
1:E:285:VAL:HA	1:E:303:VAL:CG2	2.40	0.50
1:E:155:TYR:HE2	1:E:157:LEU:HD23	1.76	0.50
1:F:164:PHE:CE1	1:F:189:LEU:HD23	2.46	0.50
1:A:227:ILE:HG22	1:A:227:ILE:O	2.12	0.50
1:B:131:PRO:HD3	2:B:401:AGS:HN61	1.77	0.50
1:B:155:TYR:O	1:B:173:THR:HA	2.11	0.50
1:C:118:HIS:HB3	1:C:196:THR:O	2.12	0.50
1:C:252:ASP:HA	1:C:255:LYS:HG3	1.94	0.50
1:D:168:LYS:H	1:D:170:GLN:HE22	1.58	0.50
1:E:126:ILE:HD11	1:E:128:ARG:NH2	2.26	0.50
1:F:122:PRO:HG3	1:F:215:SER:O	2.12	0.50
1:F:137:LEU:HD23	2:F:401:AGS:H4'	1.94	0.50
1:E:122:PRO:HD2	1:E:194:VAL:HA	1.93	0.49
1:F:294:ASP:OD1	1:F:295:ARG:N	2.45	0.49
1:F:135:LYS:HE3	1:F:222:THR:O	2.11	0.49
1:F:217:PHE:CE1	1:F:314:TYR:HB2	2.47	0.49
1:C:168:LYS:H	1:C:170:GLN:HE22	1.60	0.49
1:D:168:LYS:H	1:D:170:GLN:NE2	2.10	0.49
1:A:157:LEU:HD11	1:A:193:MET:HE1	1.93	0.49
1:E:247:ASP:OD2	1:E:295:ARG:NH1	2.45	0.49
1:C:185:LYS:O	1:C:188:SER:OG	2.20	0.49
1:D:142:ILE:HG22	1:D:219:ILE:HD13	1.95	0.49
1:C:303:VAL:O	1:C:307:VAL:HG13	2.12	0.49
2:F:401:AGS:O2A	2:F:401:AGS:O1B	2.30	0.49

Continued on next page...

Continued from previous page...

Atom-1	Atom-2	Interatomic distance (Å)	Clash overlap (Å)
1:B:190:PHE:HE1	1:B:218:VAL:HG11	1.78	0.48
1:F:134:GLY:HA3	1:F:261:LEU:HD21	1.95	0.48
1:D:250:VAL:HB	1:D:255:LYS:HD3	1.95	0.48
1:A:144:ARG:HG2	1:C:328:PHE:CE2	2.48	0.48
1:B:244:MET:HE1	1:B:301:TYR:CD2	2.48	0.48
1:E:145:ALA:HB2	1:E:278:PHE:HE1	1.77	0.48
1:A:257:ASP:O	1:A:258:LEU:HB2	2.13	0.48
1:D:122:PRO:HG2	1:D:194:VAL:HG12	1.96	0.48
1:E:126:ILE:HG12	1:E:245:ASP:OD1	2.13	0.48
1:D:216:LYS:O	1:D:217:PHE:HD1	1.96	0.48
1:E:278:PHE:CD2	1:E:285:VAL:HG11	2.49	0.48
1:C:283:PRO:HB3	1:C:288:LYS:HB2	1.93	0.48
1:E:135:LYS:O	1:E:139:THR:HG23	2.13	0.48
1:E:266:ALA:O	1:E:283:PRO:HG2	2.13	0.48
1:A:157:LEU:HD12	1:A:175:MET:HG2	1.94	0.48
1:A:207:ALA:HA	1:D:300:ARG:NH1	2.29	0.48
1:B:319:ALA:O	1:B:322:ASN:N	2.45	0.48
1:E:203:MET:HE2	1:E:208:GLU:HG2	1.95	0.48
1:E:239:ARG:HD3	1:E:242:PHE:CE2	2.49	0.47
1:E:294:ASP:O	1:E:298:LYS:HA	2.13	0.47
1:E:281:CYS:SG	1:E:286:CYS:HB3	2.54	0.47
1:B:316:ASN:O	1:B:320:ILE:HG23	2.14	0.47
1:B:123:VAL:HB	1:B:217:PHE:CD1	2.50	0.47
1:A:128:ARG:HD2	1:A:295:ARG:NH2	2.29	0.47
1:A:249:GLU:OE1	1:A:293:ARG:CZ	2.62	0.47
1:A:299:VAL:HG23	1:A:301:TYR:CE1	2.48	0.47
1:D:195:SER:HB3	1:D:197:VAL:HG12	1.97	0.47
1:B:216:LYS:O	1:B:217:PHE:HD1	1.97	0.47
1:E:178:LEU:N	1:E:221:SER:O	2.39	0.47
1:A:132:GLY:H	2:A:401:AGS:H5'1	1.79	0.47
1:C:195:SER:OG	1:C:197:VAL:HG22	2.15	0.47
1:C:265:ARG:HA	1:C:268:LYS:HZ1	1.78	0.47
1:D:243:TYR:CD2	1:D:244:MET:HG3	2.49	0.47
1:C:277:ASN:O	1:C:278:PHE:HD1	1.98	0.47
1:B:123:VAL:HB	1:B:217:PHE:CE1	2.49	0.47
1:C:145:ALA:HB2	1:C:278:PHE:HE1	1.80	0.47
1:E:118:HIS:HB2	1:E:196:THR:O	2.15	0.47
1:E:131:PRO:C	1:E:260:ARG:NH1	2.67	0.46
1:A:293:ARG:NH2	1:A:300:ARG:HH12	2.14	0.46
1:E:191:CYS:HB3	1:E:241:ARG:HH12	1.80	0.46
1:A:230:PRO:O	1:A:233:SER:N	2.49	0.46

Continued on next page...

Continued from previous page...

Atom-1	Atom-2	Interatomic distance (Å)	Clash overlap (Å)
1:C:135:LYS:N	2:C:401:AGS:O3G	2.48	0.46
1:C:186:ASP:OD1	1:C:187:MET:N	2.48	0.46
1:F:164:PHE:O	1:F:203:MET:SD	2.72	0.46
1:A:256:THR:HG23	1:A:257:ASP:O	2.14	0.46
1:B:145:ALA:HB2	1:B:278:PHE:CE1	2.51	0.46
1:B:257:ASP:OD1	1:B:257:ASP:N	2.48	0.46
1:E:260:ARG:HE	1:E:260:ARG:HB3	1.59	0.46
1:E:277:ASN:ND2	1:E:307:VAL:HG23	2.31	0.46
1:A:192:GLN:HG2	1:A:199:PHE:CD1	2.50	0.46
1:F:124:CYS:HB3	1:F:241:ARG:O	2.16	0.46
1:C:145:ALA:HB2	1:C:278:PHE:CE1	2.51	0.46
1:D:201:PRO:HD2	1:D:211:VAL:O	2.16	0.46
1:E:251:THR:HG22	1:E:253:SER:H	1.80	0.46
1:F:179:CYS:SG	1:F:187:MET:SD	3.13	0.46
1:A:178:LEU:HB3	1:A:222:THR:HG22	1.97	0.45
1:A:269:LEU:HD23	1:A:282:SER:HB3	1.98	0.45
1:F:150:TYR:HB3	1:F:171:VAL:HG21	1.98	0.45
1:E:191:CYS:SG	1:E:241:ARG:NH2	2.87	0.45
1:D:252:ASP:HA	1:D:255:LYS:HG2	1.99	0.45
1:E:131:PRO:HA	1:E:135:LYS:HZ1	1.82	0.45
1:E:191:CYS:CA	1:E:241:ARG:HH12	2.29	0.45
1:A:309:GLU:CD	1:A:312:ARG:HH21	2.19	0.45
1:E:251:THR:O	1:E:255:LYS:N	2.50	0.45
1:E:283:PRO:HB3	1:E:288:LYS:HB2	1.98	0.45
1:A:203:MET:HG3	1:A:209:ALA:HA	1.99	0.45
1:D:205:SER:HB3	1:D:208:GLU:OE1	2.17	0.45
1:E:142:ILE:HD11	1:E:219:ILE:HG21	1.99	0.45
1:F:120:ILE:HD13	1:F:318:SER:HA	1.98	0.45
1:F:129:GLY:HA3	1:F:248:ILE:CG2	2.47	0.45
1:E:256:THR:N	1:E:260:ARG:O	2.43	0.45
1:F:123:VAL:HG12	1:F:217:PHE:CD1	2.51	0.45
1:B:145:ALA:HB2	1:B:278:PHE:HE1	1.81	0.45
1:C:238:ILE:O	1:C:241:ARG:NH2	2.40	0.45
1:B:240:ARG:HH11	1:B:240:ARG:HD3	1.45	0.45
1:D:265:ARG:O	1:D:268:LYS:HG2	2.16	0.45
1:D:269:LEU:HD23	1:D:282:SER:HB2	1.98	0.45
1:F:128:ARG:HB2	1:F:247:ASP:OD1	2.17	0.45
1:A:189:LEU:HD12	1:A:190:PHE:N	2.32	0.44
1:F:122:PRO:HA	1:F:216:LYS:O	2.17	0.44
1:F:285:VAL:HA	1:F:303:VAL:CG2	2.47	0.44
1:D:194:VAL:HG23	1:D:241:ARG:HD2	1.98	0.44

Continued on next page...

Continued from previous page...

Atom-1	Atom-2	Interatomic distance (Å)	Clash overlap (Å)
1:D:244:MET:HE1	1:D:306:VAL:HG23	1.98	0.44
1:F:146:ILE:HG21	1:F:217:PHE:CD2	2.52	0.44
1:B:193:MET:HE2	1:B:193:MET:HB2	1.80	0.44
1:D:145:ALA:HB2	1:D:278:PHE:CE1	2.52	0.44
1:D:155:TYR:HB2	1:D:170:GLN:OE1	2.18	0.44
1:D:217:PHE:HE1	1:D:314:TYR:HB2	1.83	0.44
1:E:125:LEU:HA	1:E:244:MET:O	2.18	0.44
1:E:216:LYS:C	1:E:217:PHE:HD1	2.21	0.44
1:E:301:TYR:HB3	1:E:306:VAL:HG13	1.99	0.44
1:B:228:ILE:O	1:B:228:ILE:HG23	2.17	0.44
1:E:131:PRO:HA	1:E:135:LYS:NZ	2.32	0.44
1:E:142:ILE:HD11	1:E:219:ILE:HG12	2.00	0.44
1:A:168:LYS:O	1:A:168:LYS:HG2	2.17	0.44
1:C:265:ARG:HA	1:C:268:LYS:HZ3	1.79	0.44
1:F:160:ASP:OD2	1:F:182:PRO:HG3	2.18	0.44
1:B:126:ILE:HB	1:B:242:PHE:CE1	2.52	0.44
1:B:180:GLN:O	1:B:183:ASP:HB3	2.17	0.44
1:D:150:TYR:CD2	1:D:171:VAL:HG11	2.52	0.44
1:D:254:TYR:HD2	4:D:501:HOH:O	2.00	0.44
1:E:164:PHE:CD2	1:E:201:PRO:HB3	2.52	0.44
1:D:155:TYR:O	1:D:173:THR:HA	2.18	0.44
1:D:176:ASP:HB3	2:D:401:AGS:H3'	1.99	0.44
1:E:216:LYS:HB3	1:E:314:TYR:CE2	2.53	0.44
1:B:273:ASN:OD1	1:B:281:CYS:HB2	2.18	0.43
1:E:142:ILE:CD1	1:E:219:ILE:HG12	2.48	0.43
1:E:145:ALA:HB2	1:E:278:PHE:CE1	2.53	0.43
1:E:254:TYR:CD1	1:E:265:ARG:HD3	2.53	0.43
1:D:303:VAL:O	1:D:307:VAL:HG13	2.18	0.43
1:C:134:GLY:HA2	2:C:401:AGS:O2G	2.18	0.43
1:C:281:CYS:SG	1:C:282:SER:N	2.90	0.43
1:F:128:ARG:NH2	1:F:245:ASP:OD2	2.43	0.43
1:A:227:ILE:O	1:A:227:ILE:CG2	2.67	0.43
1:F:180:GLN:HG3	1:F:181:ASN:N	2.33	0.43
1:F:183:ASP:OD2	1:F:185:LYS:HE2	2.18	0.43
1:B:192:GLN:HB3	1:B:199:PHE:CD1	2.54	0.43
1:C:216:LYS:O	1:C:217:PHE:HD1	2.01	0.43
1:E:128:ARG:HG2	1:E:222:THR:CG2	2.48	0.43
1:E:129:GLY:HA3	1:E:248:ILE:HG22	2.00	0.43
1:F:152:SER:HB2	1:F:171:VAL:HG23	2.01	0.43
1:A:145:ALA:HB2	1:A:278:PHE:HE1	1.83	0.43
1:B:191:CYS:O	1:B:241:ARG:NH1	2.52	0.43

Continued on next page...

Continued from previous page...

Atom-1	Atom-2	Interatomic distance (Å)	Clash overlap (Å)
1:B:228:ILE:O	1:B:228:ILE:HG13	2.18	0.43
1:C:321:GLY:O	1:C:324:ILE:HG13	2.19	0.43
1:D:118:HIS:CE1	1:D:197:VAL:HA	2.54	0.43
1:E:137:LEU:HD23	2:E:401:AGS:H4'	1.99	0.43
1:F:287:GLY:HA2	1:F:290:ILE:O	2.19	0.43
1:A:257:ASP:N	1:A:257:ASP:OD1	2.52	0.43
1:C:244:MET:HE2	1:C:244:MET:HB3	1.54	0.43
1:D:132:GLY:HA3	1:D:260:ARG:HD3	2.01	0.43
1:D:208:GLU:OE1	1:D:208:GLU:N	2.52	0.43
1:A:228:ILE:HD11	1:A:239:ARG:CZ	2.49	0.42
1:E:131:PRO:O	1:E:260:ARG:NH2	2.52	0.42
1:E:244:MET:HE3	1:E:294:ASP:HA	2.00	0.42
1:B:150:TYR:CE1	1:B:311:ILE:HD12	2.43	0.42
1:A:217:PHE:CE1	1:A:314:TYR:HB2	2.55	0.42
1:A:254:TYR:CD1	1:A:254:TYR:N	2.87	0.42
1:D:131:PRO:HG2	1:D:260:ARG:NH1	2.34	0.42
1:E:244:MET:CE	1:E:294:ASP:HA	2.49	0.42
1:F:164:PHE:N	1:F:164:PHE:CD1	2.88	0.42
1:A:164:PHE:N	1:A:164:PHE:CD1	2.87	0.42
1:A:232:VAL:CG1	1:A:233:SER:N	2.73	0.42
1:D:167:TYR:CZ	1:D:169:GLN:HA	2.54	0.42
1:D:168:LYS:O	1:D:169:GLN:HB2	2.18	0.42
1:F:292:LEU:HD12	1:F:306:VAL:HG11	2.01	0.42
2:B:401:AGS:S1G	2:B:401:AGS:O3A	2.78	0.42
1:E:157:LEU:HD21	1:E:164:PHE:CE1	2.55	0.42
1:C:247:ASP:OD1	1:C:295:ARG:NH1	2.43	0.42
1:B:130:SER:HB2	1:B:131:PRO:HD2	2.02	0.42
1:B:190:PHE:HD1	1:B:193:MET:HE3	1.84	0.42
1:B:201:PRO:HD2	1:B:211:VAL:O	2.19	0.42
1:C:244:MET:HE3	1:C:301:TYR:HE2	1.85	0.42
1:D:216:LYS:HD3	1:D:314:TYR:CE2	2.54	0.42
1:F:153:SER:O	1:F:170:GLN:HB3	2.20	0.42
1:F:183:ASP:HB2	1:F:185:LYS:HG3	2.02	0.42
1:F:248:ILE:HD11	1:F:290:ILE:CG2	2.48	0.42
1:A:328:PHE:HZ	1:F:141:ILE:HG13	1.85	0.42
1:B:256:THR:HG22	1:B:260:ARG:O	2.20	0.42
1:B:303:VAL:O	1:B:307:VAL:HG23	2.20	0.42
1:D:137:LEU:O	1:D:141:ILE:HG12	2.20	0.42
1:D:145:ALA:HB2	1:D:278:PHE:HE1	1.85	0.42
1:A:293:ARG:HD2	1:A:298:LYS:NZ	2.35	0.42
1:C:304:ASP:O	1:C:307:VAL:HG22	2.20	0.42

Continued on next page...

Continued from previous page...

Atom-1	Atom-2	Interatomic distance (Å)	Clash overlap (Å)
1:E:145:ALA:CB	1:E:278:PHE:HE1	2.32	0.42
1:E:159:PRO:HB3	1:E:180:GLN:OE1	2.20	0.42
1:E:200:ILE:HA	1:E:201:PRO:HD3	1.76	0.42
1:C:273:ASN:OD1	1:C:281:CYS:HB2	2.19	0.41
1:E:123:VAL:HG23	1:E:243:TYR:CB	2.50	0.41
1:F:152:SER:OG	1:F:171:VAL:N	2.40	0.41
1:A:298:LYS:O	1:A:298:LYS:HG3	2.20	0.41
1:C:254:TYR:HD2	4:C:502:HOH:O	2.04	0.41
1:D:200:ILE:HD13	1:D:212:SER:HA	2.02	0.41
1:D:254:TYR:HA	1:D:265:ARG:NH2	2.35	0.41
1:A:163:HIS:HE2	1:C:238:ILE:N	2.18	0.41
1:F:123:VAL:HG23	1:F:243:TYR:CB	2.50	0.41
1:F:139:THR:HG21	1:F:221:SER:HB3	2.02	0.41
1:A:180:GLN:O	1:A:182:PRO:HD3	2.19	0.41
1:C:243:TYR:CD2	1:C:244:MET:HG3	2.55	0.41
1:C:292:LEU:HD12	1:C:306:VAL:HG11	2.01	0.41
1:F:180:GLN:HG3	1:F:181:ASN:OD1	2.20	0.41
1:F:223:ASN:HB2	1:F:226:ASN:ND2	2.34	0.41
1:B:168:LYS:HG3	1:B:168:LYS:O	2.20	0.41
1:C:135:LYS:NZ	1:C:223:ASN:OD1	2.50	0.41
1:C:243:TYR:CZ	1:C:313:GLU:HG2	2.55	0.41
1:C:293:ARG:NH2	1:C:300:ARG:HD3	2.35	0.41
1:C:145:ALA:CB	1:C:278:PHE:HE1	2.33	0.41
1:C:174:VAL:HA	1:C:219:ILE:O	2.21	0.41
1:E:128:ARG:NH1	1:E:245:ASP:OD2	2.45	0.41
1:E:217:PHE:HZ	1:E:311:ILE:HA	1.86	0.41
1:A:234:ASP:HB3	1:A:237:ALA:CB	2.51	0.41
1:B:174:VAL:HA	1:B:219:ILE:O	2.21	0.41
1:D:314:TYR:CE2	1:D:318:SER:HB2	2.56	0.41
1:E:175:MET:SD	1:E:178:LEU:HD12	2.61	0.41
1:F:213:PHE:CZ	1:F:215:SER:HB2	2.55	0.41
1:F:222:THR:HG22	1:F:223:ASN:N	2.33	0.41
1:F:277:ASN:OD1	1:F:307:VAL:HG13	2.20	0.41
1:F:281:CYS:SG	1:F:286:CYS:HB3	2.60	0.41
1:F:322:ASN:OD1	1:F:323:THR:HG23	2.20	0.41
1:B:244:MET:HE1	1:B:301:TYR:HD2	1.85	0.41
1:D:128:ARG:HH11	1:D:295:ARG:NH1	2.19	0.41
1:A:234:ASP:OD1	1:A:235:SER:N	2.53	0.41
1:A:324:ILE:O	1:A:327:LEU:HG	2.21	0.41
1:D:136:SER:OG	2:D:401:AGS:O5'	2.38	0.41
1:D:217:PHE:CE1	1:D:314:TYR:HB2	2.56	0.41

Continued on next page...

Continued from previous page...

Atom-1	Atom-2	Interatomic distance (Å)	Clash overlap (Å)
1:D:262:ASP:OD2	1:D:265:ARG:NE	2.52	0.41
1:E:123:VAL:HG23	1:E:243:TYR:HB3	2.03	0.41
1:E:175:MET:O	1:E:220:ALA:HA	2.21	0.41
1:E:191:CYS:HA	1:E:241:ARG:HH12	1.86	0.41
1:E:293:ARG:HA	1:E:299:VAL:O	2.21	0.41
1:A:128:ARG:HG2	1:A:222:THR:OG1	2.21	0.41
1:E:164:PHE:HB2	1:E:203:MET:SD	2.60	0.41
1:E:243:TYR:CE1	1:E:313:GLU:HG3	2.56	0.41
1:D:216:LYS:C	1:D:217:PHE:HD1	2.25	0.40
1:E:244:MET:HE1	1:E:294:ASP:CB	2.51	0.40
1:F:193:MET:HE2	1:F:193:MET:HA	2.03	0.40
1:C:154:VAL:HG13	1:C:172:VAL:HG13	2.01	0.40
2:D:401:AGS:O3A	2:D:401:AGS:O2G	2.40	0.40
1:E:256:THR:HG22	1:E:260:ARG:H	1.87	0.40
1:F:200:ILE:HA	1:F:201:PRO:HD3	1.78	0.40
1:E:135:LYS:HG2	2:E:401:AGS:O2B	2.22	0.40
1:E:206:LEU:HD23	1:E:206:LEU:HA	1.94	0.40
1:E:277:ASN:O	1:E:278:PHE:HD1	2.04	0.40
1:A:144:ARG:NH2	1:C:325:GLU:OE2	2.53	0.40
1:A:201:PRO:HA	1:A:202:PRO:HD3	1.96	0.40
1:B:145:ALA:CB	1:B:278:PHE:HE1	2.34	0.40
1:E:164:PHE:CE2	1:E:189:LEU:HD21	2.56	0.40
1:B:203:MET:HG3	1:B:209:ALA:HA	2.02	0.40
1:C:121:GLU:OE1	1:C:317:ARG:NH1	2.54	0.40

All (1) symmetry-related close contacts are listed below. The label for Atom-2 includes the symmetry operator and encoded unit-cell translations to be applied.

Atom-1	Atom-2	Interatomic distance (Å)	Clash overlap (Å)
1:B:144:ARG:NH1	1:D:325:GLU:OE2[1_545]	2.15	0.05

5.3 Torsion angles [i](#)

5.3.1 Protein backbone [i](#)

In the following table, the Percentiles column shows the percent Ramachandran outliers of the chain as a percentile score with respect to all X-ray entries followed by that with respect to entries of similar resolution.

The Analysed column shows the number of residues for which the backbone conformation was

analysed, and the total number of residues.

Mol	Chain	Analysed	Favoured	Allowed	Outliers	Percentiles	
1	A	209/214 (98%)	198 (95%)	7 (3%)	4 (2%)	8	26
1	B	210/214 (98%)	199 (95%)	9 (4%)	2 (1%)	15	44
1	C	191/214 (89%)	187 (98%)	3 (2%)	1 (0%)	29	61
1	D	195/214 (91%)	181 (93%)	14 (7%)	0	100	100
1	E	204/214 (95%)	195 (96%)	9 (4%)	0	100	100
1	F	204/214 (95%)	194 (95%)	9 (4%)	1 (0%)	29	61
All	All	1213/1284 (94%)	1154 (95%)	51 (4%)	8 (1%)	22	53

All (8) Ramachandran outliers are listed below:

Mol	Chain	Res	Type
1	B	232	VAL
1	A	181	ASN
1	C	169	GLN
1	A	182	PRO
1	A	228	ILE
1	A	232	VAL
1	B	229	VAL
1	F	182	PRO

5.3.2 Protein sidechains [i](#)

In the following table, the Percentiles column shows the percent sidechain outliers of the chain as a percentile score with respect to all X-ray entries followed by that with respect to entries of similar resolution.

The Analysed column shows the number of residues for which the sidechain conformation was analysed, and the total number of residues.

Mol	Chain	Analysed	Rotameric	Outliers	Percentiles	
1	A	183/186 (98%)	181 (99%)	2 (1%)	73	92
1	B	184/186 (99%)	183 (100%)	1 (0%)	88	96
1	C	171/186 (92%)	170 (99%)	1 (1%)	86	96
1	D	176/186 (95%)	176 (100%)	0	100	100
1	E	180/186 (97%)	180 (100%)	0	100	100
1	F	180/186 (97%)	178 (99%)	2 (1%)	73	92
All	All	1074/1116 (96%)	1068 (99%)	6 (1%)	86	96

All (6) residues with a non-rotameric sidechain are listed below:

Mol	Chain	Res	Type
1	A	254	TYR
1	A	301	TYR
1	B	229	VAL
1	C	313	GLU
1	F	164	PHE
1	F	278	PHE

Sometimes sidechains can be flipped to improve hydrogen bonding and reduce clashes. All (3) such sidechains are listed below:

Mol	Chain	Res	Type
1	A	226	ASN
1	B	180	GLN
1	F	277	ASN

5.3.3 RNA [i](#)

There are no RNA molecules in this entry.

5.4 Non-standard residues in protein, DNA, RNA chains [i](#)

There are no non-standard protein/DNA/RNA residues in this entry.

5.5 Carbohydrates [i](#)

There are no monosaccharides in this entry.

5.6 Ligand geometry [i](#)

Of 12 ligands modelled in this entry, 6 are monoatomic - leaving 6 for Mogul analysis.

In the following table, the Counts columns list the number of bonds (or angles) for which Mogul statistics could be retrieved, the number of bonds (or angles) that are observed in the model and the number of bonds (or angles) that are defined in the Chemical Component Dictionary. The Link column lists molecule types, if any, to which the group is linked. The Z score for a bond length (or angle) is the number of standard deviations the observed value is removed from the expected value. A bond length (or angle) with $|Z| > 2$ is considered an outlier worth inspection. RMSZ is the root-mean-square of all Z scores of the bond lengths (or angles).

Mol	Type	Chain	Res	Link	Bond lengths			Bond angles		
					Counts	RMSZ	# Z > 2	Counts	RMSZ	# Z > 2
2	AGS	C	401	-	26,33,33	0.70	1 (3%)	26,52,52	1.21	2 (7%)
2	AGS	B	401	-	26,33,33	0.68	1 (3%)	26,52,52	0.89	2 (7%)
2	AGS	E	401	-	26,33,33	0.72	1 (3%)	26,52,52	1.63	3 (11%)
2	AGS	F	401	-	26,33,33	0.69	1 (3%)	26,52,52	1.52	2 (7%)
2	AGS	D	401	-	26,33,33	0.55	0	26,52,52	0.99	2 (7%)
2	AGS	A	401	-	26,33,33	0.79	1 (3%)	26,52,52	1.79	5 (19%)

In the following table, the Chirals column lists the number of chiral outliers, the number of chiral centers analysed, the number of these observed in the model and the number defined in the Chemical Component Dictionary. Similar counts are reported in the Torsion and Rings columns. '-' means no outliers of that kind were identified.

Mol	Type	Chain	Res	Link	Chirals	Torsions	Rings
2	AGS	C	401	-	-	4/17/38/38	0/3/3/3
2	AGS	B	401	-	-	8/17/38/38	0/3/3/3
2	AGS	E	401	-	-	5/17/38/38	0/3/3/3
2	AGS	F	401	-	-	3/17/38/38	0/3/3/3
2	AGS	D	401	-	-	1/17/38/38	0/3/3/3
2	AGS	A	401	-	-	7/17/38/38	0/3/3/3

All (5) bond length outliers are listed below:

Mol	Chain	Res	Type	Atoms	Z	Observed(Å)	Ideal(Å)
2	A	401	AGS	PG-S1G	2.46	1.96	1.90
2	F	401	AGS	PG-S1G	2.37	1.95	1.90
2	E	401	AGS	PG-S1G	2.36	1.95	1.90
2	B	401	AGS	PG-S1G	2.23	1.95	1.90
2	C	401	AGS	PG-S1G	2.16	1.95	1.90

All (16) bond angle outliers are listed below:

Mol	Chain	Res	Type	Atoms	Z	Observed(°)	Ideal(°)
2	F	401	AGS	PA-O3A-PB	-6.78	109.58	132.83
2	A	401	AGS	PA-O3A-PB	-6.38	110.95	132.83
2	E	401	AGS	PA-O3A-PB	-6.36	111.02	132.83
2	C	401	AGS	PA-O3A-PB	-4.51	117.36	132.83
2	E	401	AGS	C3'-C2'-C1'	3.00	105.50	100.98
2	A	401	AGS	O3G-PG-O3B	-2.91	94.92	104.64
2	A	401	AGS	C3'-C2'-C1'	2.49	104.73	100.98

Continued on next page...

Continued from previous page...

Mol	Chain	Res	Type	Atoms	Z	Observed(°)	Ideal(°)
2	D	401	AGS	O2G-PG-O3B	2.33	112.41	104.64
2	C	401	AGS	C5-C6-N6	2.29	123.84	120.35
2	D	401	AGS	C5-C6-N6	2.29	123.83	120.35
2	B	401	AGS	PA-O3A-PB	-2.22	125.20	132.83
2	A	401	AGS	C5-C6-N6	2.22	123.73	120.35
2	A	401	AGS	O2G-PG-O3B	2.20	111.98	104.64
2	E	401	AGS	C5-C6-N6	2.18	123.66	120.35
2	B	401	AGS	C5-C6-N6	2.15	123.62	120.35
2	F	401	AGS	C5-C6-N6	2.15	123.62	120.35

There are no chirality outliers.

All (28) torsion outliers are listed below:

Mol	Chain	Res	Type	Atoms
2	A	401	AGS	PB-O3B-PG-O2G
2	A	401	AGS	PB-O3B-PG-O3G
2	A	401	AGS	C5'-O5'-PA-O2A
2	B	401	AGS	PB-O3B-PG-O2G
2	B	401	AGS	PB-O3B-PG-O3G
2	B	401	AGS	C5'-O5'-PA-O3A
2	B	401	AGS	O4'-C4'-C5'-O5'
2	B	401	AGS	C3'-C4'-C5'-O5'
2	C	401	AGS	C5'-O5'-PA-O1A
2	C	401	AGS	C5'-O5'-PA-O2A
2	D	401	AGS	C4'-C5'-O5'-PA
2	E	401	AGS	C5'-O5'-PA-O3A
2	A	401	AGS	O4'-C4'-C5'-O5'
2	A	401	AGS	C3'-C4'-C5'-O5'
2	E	401	AGS	C4'-C5'-O5'-PA
2	B	401	AGS	PB-O3A-PA-O5'
2	E	401	AGS	O4'-C4'-C5'-O5'
2	F	401	AGS	C4'-C5'-O5'-PA
2	A	401	AGS	C5'-O5'-PA-O1A
2	B	401	AGS	C5'-O5'-PA-O1A
2	E	401	AGS	C5'-O5'-PA-O2A
2	E	401	AGS	PG-O3B-PB-O2B
2	B	401	AGS	PG-O3B-PB-O3A
2	C	401	AGS	C3'-C4'-C5'-O5'
2	F	401	AGS	O4'-C4'-C5'-O5'
2	F	401	AGS	PG-O3B-PB-O2B
2	A	401	AGS	C5'-O5'-PA-O3A
2	C	401	AGS	C5'-O5'-PA-O3A

There are no ring outliers.

6 monomers are involved in 23 short contacts:

Mol	Chain	Res	Type	Clashes	Symm-Clashes
2	C	401	AGS	4	0
2	B	401	AGS	3	0
2	E	401	AGS	3	0
2	F	401	AGS	3	0
2	D	401	AGS	4	0
2	A	401	AGS	6	0

The following is a two-dimensional graphical depiction of Mogul quality analysis of bond lengths, bond angles, torsion angles, and ring geometry for all instances of the Ligand of Interest. In addition, ligands with molecular weight > 250 and outliers as shown on the validation Tables will also be included. For torsion angles, if less than 5% of the Mogul distribution of torsion angles is within 10 degrees of the torsion angle in question, then that torsion angle is considered an outlier. Any bond that is central to one or more torsion angles identified as an outlier by Mogul will be highlighted in the graph. For rings, the root-mean-square deviation (RMSD) between the ring in question and similar rings identified by Mogul is calculated over all ring torsion angles. If the average RMSD is greater than 60 degrees and the minimal RMSD between the ring in question and any Mogul-identified rings is also greater than 60 degrees, then that ring is considered an outlier. The outliers are highlighted in purple. The color gray indicates Mogul did not find sufficient equivalents in the CSD to analyse the geometry.

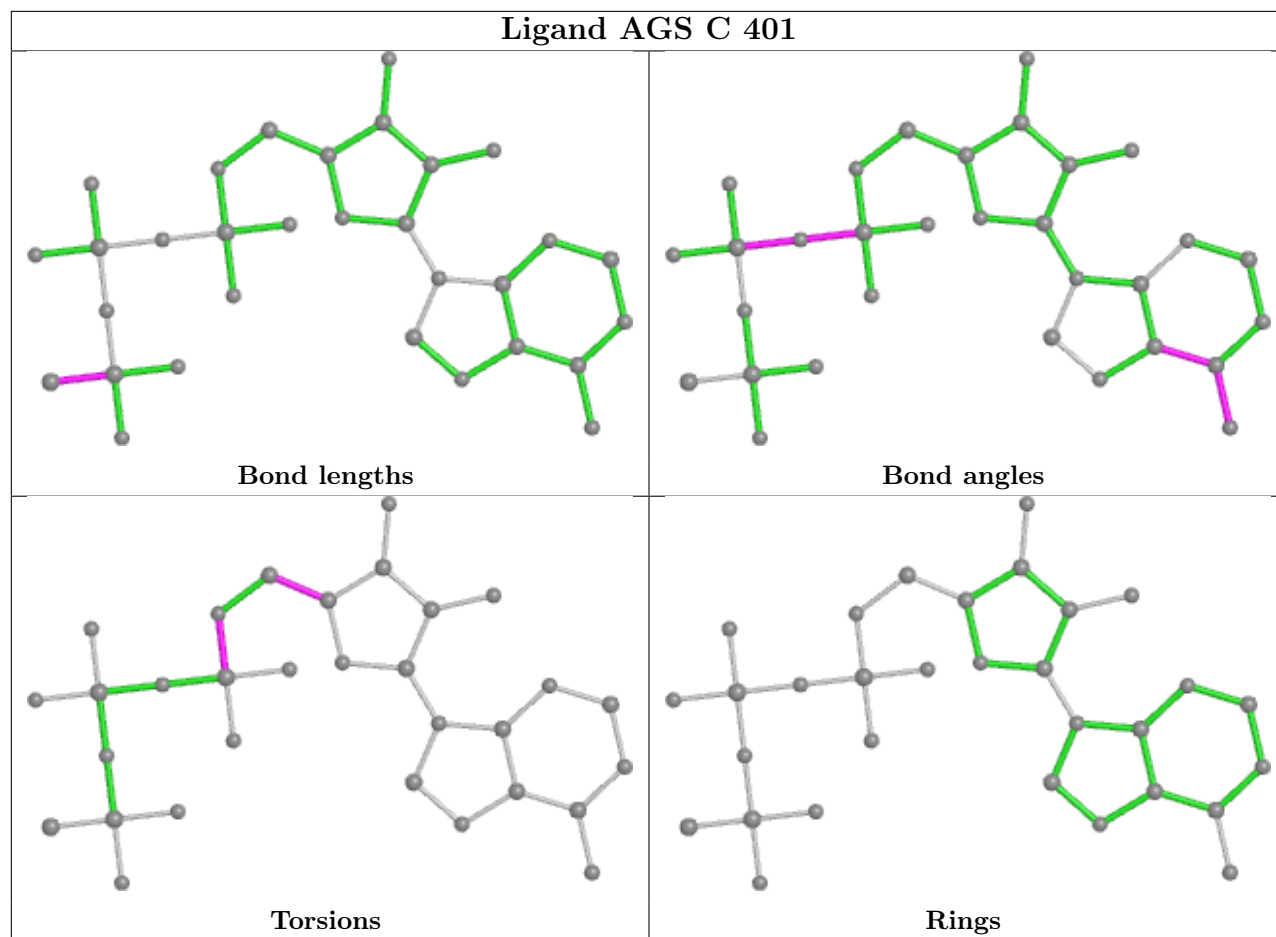

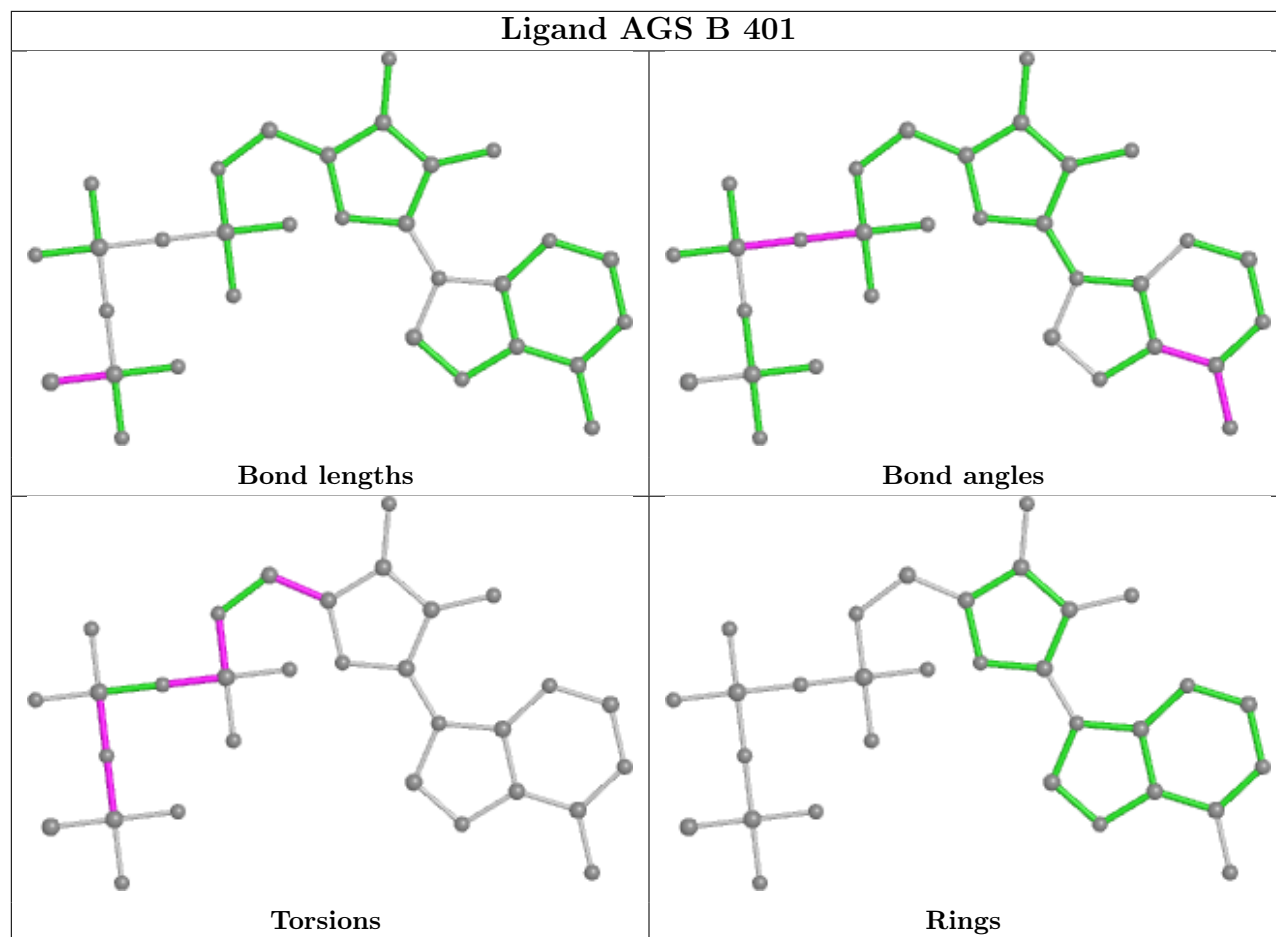

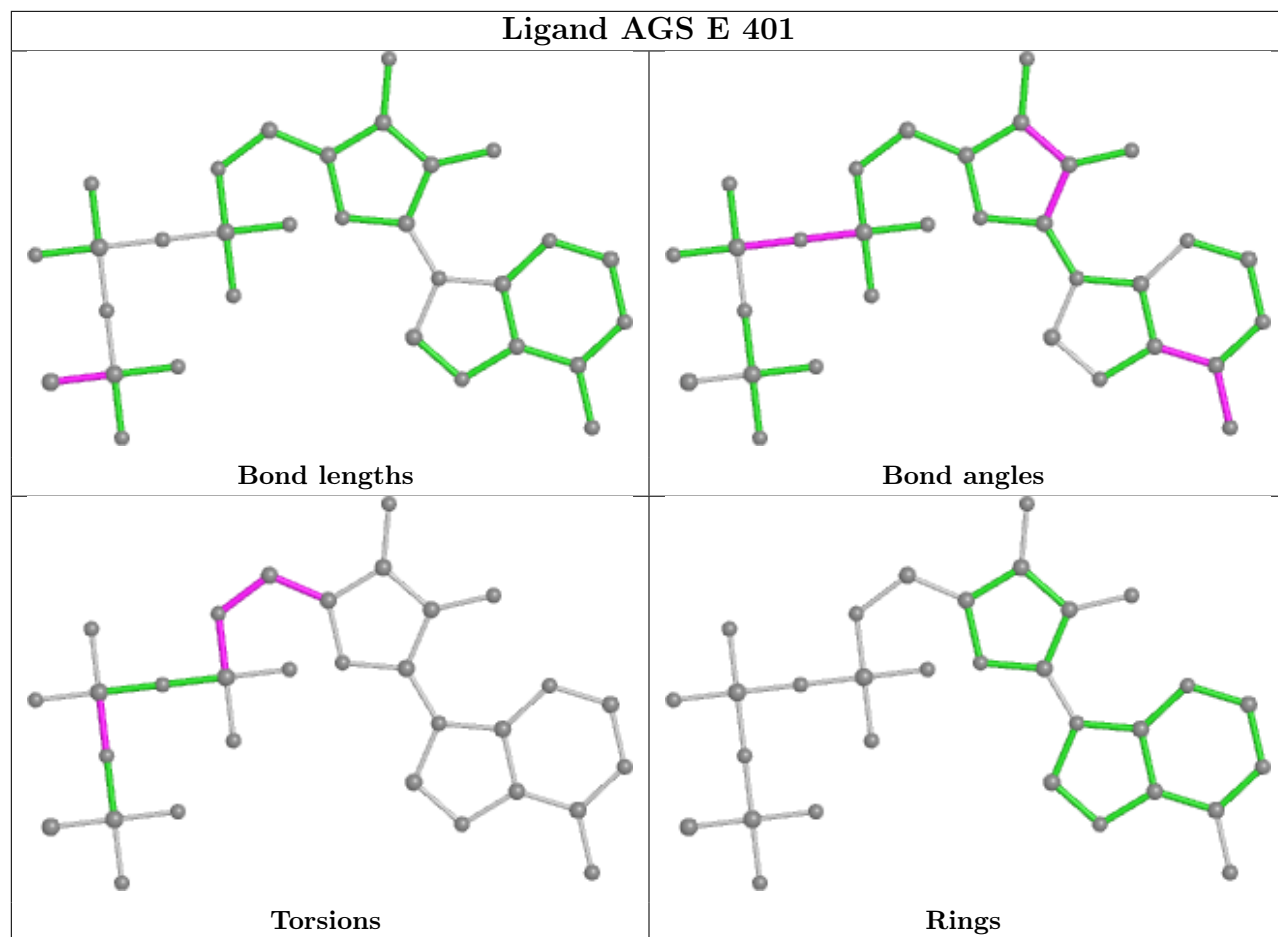

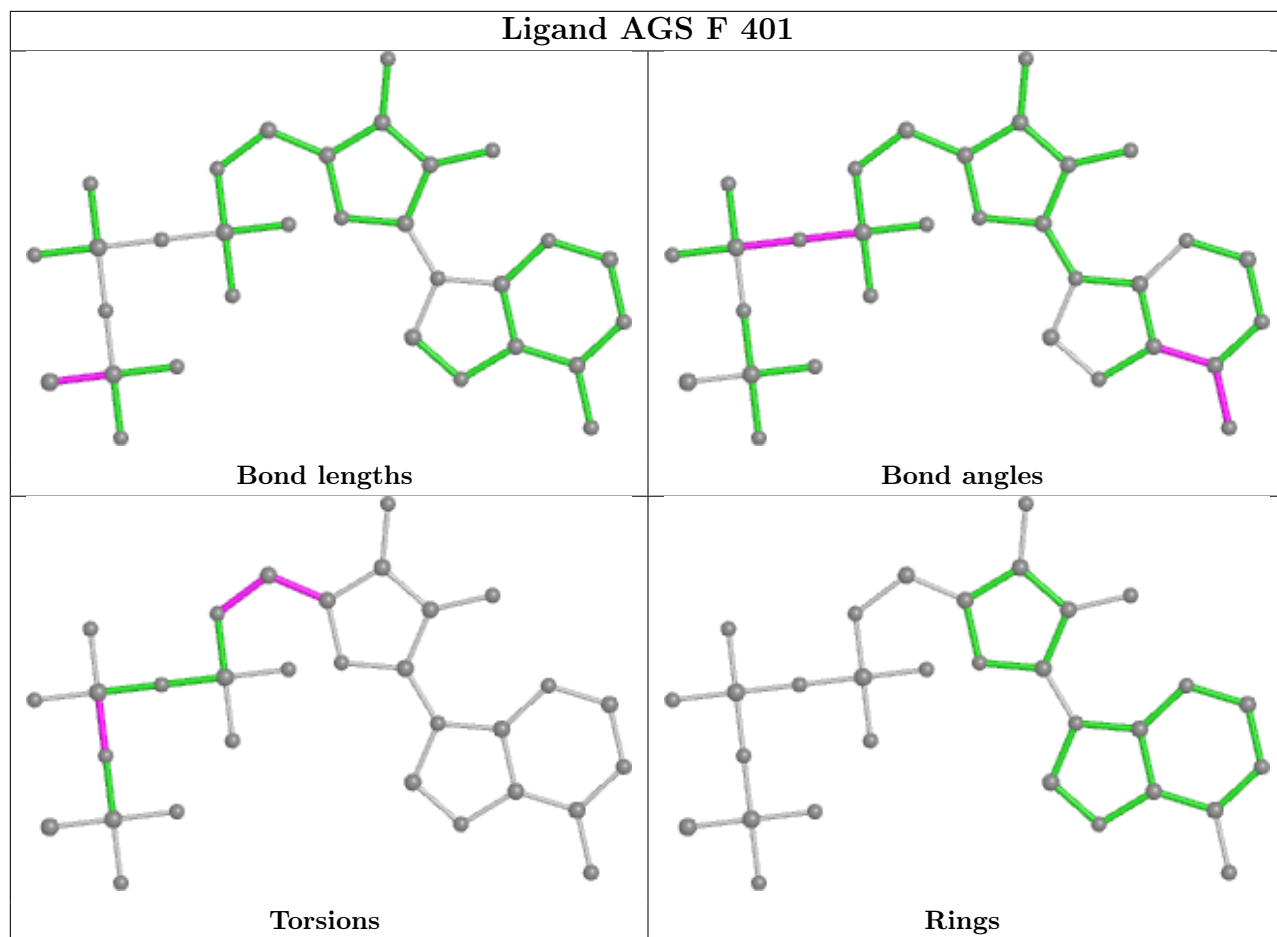

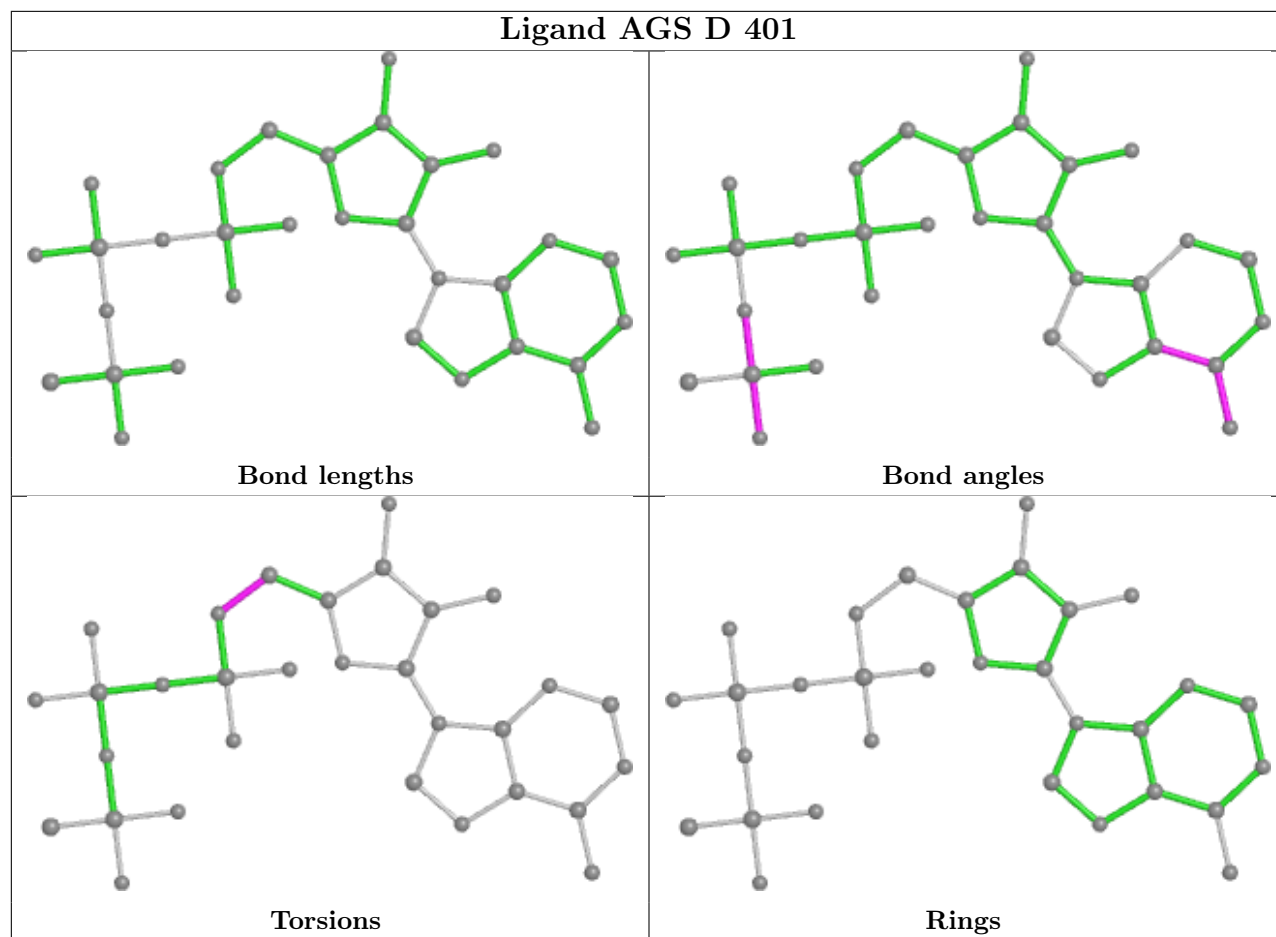

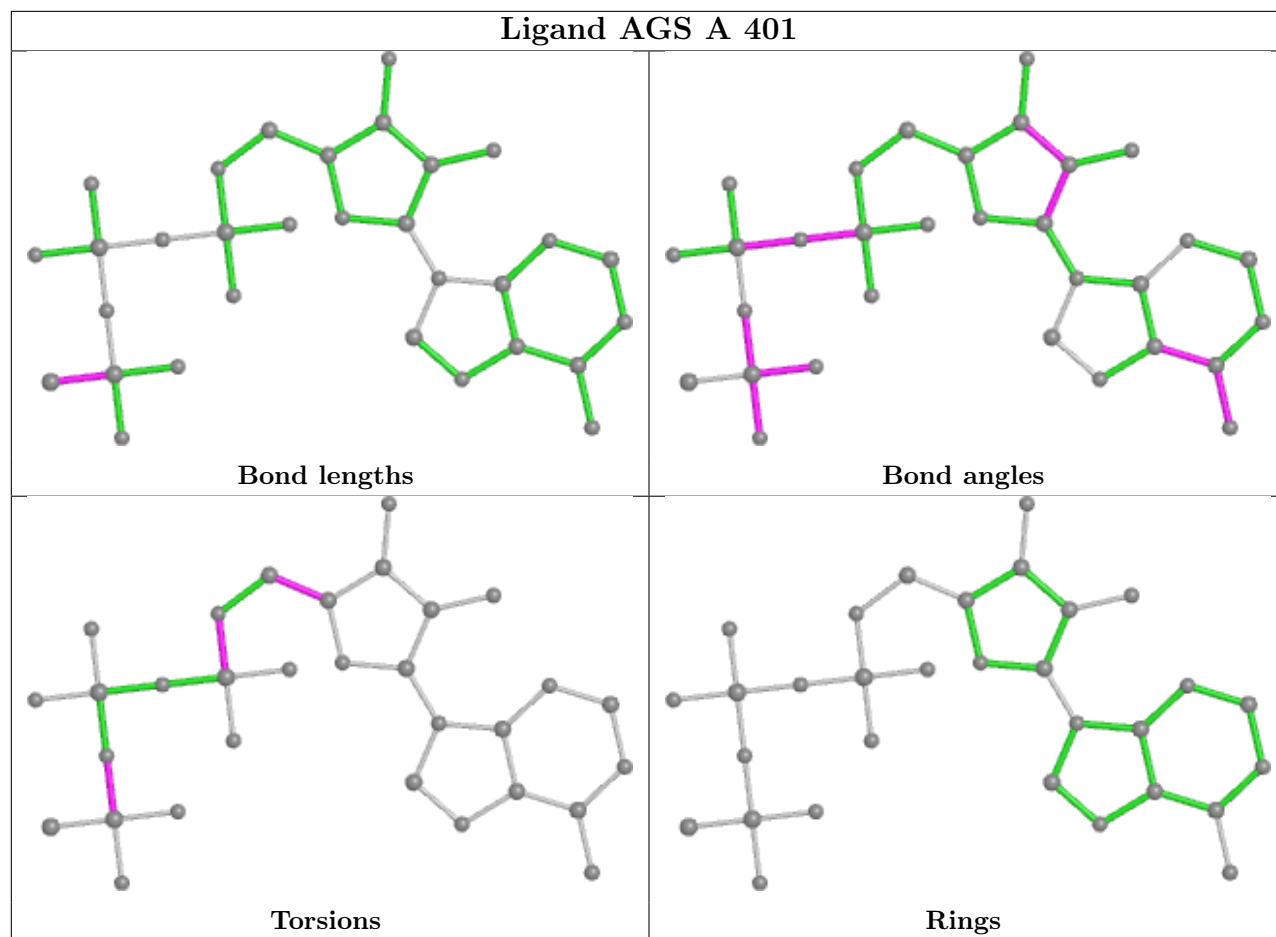

5.7 Other polymers [i](#)

There are no such residues in this entry.

5.8 Polymer linkage issues [i](#)

There are no chain breaks in this entry.

6 Fit of model and data

6.1 Protein, DNA and RNA chains

In the following table, the column labelled ‘#RSRZ > 2’ contains the number (and percentage) of RSRZ outliers, followed by percent RSRZ outliers for the chain as percentile scores relative to all X-ray entries and entries of similar resolution. The OWAB column contains the minimum, median, 95th percentile and maximum values of the occupancy-weighted average B-factor per residue. The column labelled ‘Q < 0.9’ lists the number of (and percentage) of residues with an average occupancy less than 0.9.

Mol	Chain	Analysed	<RSRZ>	#RSRZ>2	OWAB(Å ²)	Q<0.9
1	A	211/214 (98%)	-0.06	3 (1%) 75 70	35, 62, 101, 120	0
1	B	212/214 (99%)	-0.07	4 (1%) 66 59	37, 61, 103, 126	0
1	C	199/214 (92%)	0.18	10 (5%) 28 19	39, 67, 108, 146	0
1	D	203/214 (94%)	0.20	10 (4%) 29 20	38, 67, 114, 145	0
1	E	208/214 (97%)	0.78	22 (10%) 6 3	70, 106, 136, 158	0
1	F	208/214 (97%)	0.67	25 (12%) 4 2	69, 102, 140, 158	0
All	All	1241/1284 (96%)	0.28	74 (5%) 21 14	35, 78, 130, 158	0

All (74) RSRZ outliers are listed below:

Mol	Chain	Res	Type	RSRZ
1	E	208	GLU	13.2
1	E	207	ALA	11.0
1	F	207	ALA	10.2
1	E	227	ILE	9.6
1	F	233	SER	8.7
1	E	117	LYS	7.8
1	F	227	ILE	7.2
1	E	211	VAL	7.0
1	C	181	ASN	6.9
1	E	225	THR	6.3
1	E	228	ILE	6.0
1	D	181	ASN	5.9
1	F	117	LYS	5.6
1	D	228	ILE	5.5
1	E	233	SER	5.5
1	F	118	HIS	5.1
1	C	183	ASP	4.8
1	D	227	ILE	4.8
1	F	225	THR	4.7

Continued on next page...

Continued from previous page...

Mol	Chain	Res	Type	RSRZ
1	E	194	VAL	4.5
1	F	228	ILE	4.5
1	C	180	GLN	4.3
1	F	208	GLU	4.1
1	D	229	VAL	3.7
1	E	187	MET	3.7
1	B	179	CYS	3.7
1	F	197	VAL	3.5
1	F	194	VAL	3.5
1	E	209	ALA	3.4
1	D	180	GLN	3.4
1	C	179	CYS	3.3
1	E	217	PHE	3.2
1	F	226	ASN	3.2
1	C	225	THR	3.1
1	C	260	ARG	3.0
1	D	189	LEU	2.9
1	E	169	GLN	2.9
1	F	205	SER	2.9
1	F	119	ARG	2.9
1	F	240	ARG	2.9
1	F	301	TYR	2.8
1	E	210	GLY	2.7
1	B	181	ASN	2.7
1	F	210	GLY	2.6
1	E	235	SER	2.5
1	E	318	SER	2.5
1	F	209	ALA	2.5
1	E	214	THR	2.4
1	C	161	PRO	2.4
1	F	183	ASP	2.4
1	C	257	ASP	2.4
1	F	217	PHE	2.3
1	E	118	HIS	2.3
1	F	181	ASN	2.2
1	D	257	ASP	2.2
1	D	260	ARG	2.2
1	C	184	GLY	2.2
1	D	161	PRO	2.2
1	F	182	PRO	2.2
1	E	248	ILE	2.2
1	E	301	TYR	2.2

Continued on next page...

Continued from previous page...

Mol	Chain	Res	Type	RSRZ
1	B	187	MET	2.2
1	A	186	ASP	2.2
1	F	320	ILE	2.2
1	C	250	VAL	2.2
1	A	190	PHE	2.1
1	F	189	LEU	2.1
1	E	290	ILE	2.1
1	F	180	GLN	2.1
1	E	226	ASN	2.1
1	A	178	LEU	2.0
1	F	157	LEU	2.0
1	B	289	ALA	2.0
1	D	226	ASN	2.0

6.2 Non-standard residues in protein, DNA, RNA chains [i](#)

There are no non-standard protein/DNA/RNA residues in this entry.

6.3 Carbohydrates [i](#)

There are no monosaccharides in this entry.

6.4 Ligands [i](#)

In the following table, the Atoms column lists the number of modelled atoms in the group and the number defined in the chemical component dictionary. The B-factors column lists the minimum, median, 95th percentile and maximum values of B factors of atoms in the group. The column labelled 'Q< 0.9' lists the number of atoms with occupancy less than 0.9.

Mol	Type	Chain	Res	Atoms	RSCC	RSR	B-factors(Å ²)	Q<0.9
2	AGS	D	401	31/31	0.87	0.31	74,130,145,153	0
2	AGS	B	401	31/31	0.88	0.19	59,110,138,141	0
2	AGS	C	401	31/31	0.89	0.29	71,118,135,138	31
2	AGS	F	401	31/31	0.89	0.18	81,93,110,112	0
2	AGS	A	401	31/31	0.90	0.19	64,86,118,125	31
2	AGS	E	401	31/31	0.92	0.14	78,89,104,106	0
3	ZN	E	402	1/1	0.94	0.20	91,91,91,91	0
3	ZN	F	402	1/1	0.95	0.18	86,86,86,86	0
3	ZN	D	402	1/1	0.96	0.21	54,54,54,54	0
3	ZN	C	402	1/1	0.97	0.21	64,64,64,64	0

Continued on next page...

Continued from previous page...

Mol	Type	Chain	Res	Atoms	RSCC	RSR	B-factors(\AA^2)	Q<0.9
3	ZN	A	402	1/1	0.98	0.19	56,56,56,56	0
3	ZN	B	402	1/1	0.99	0.22	47,47,47,47	0

The following is a graphical depiction of the model fit to experimental electron density of all instances of the Ligand of Interest. In addition, ligands with molecular weight > 250 and outliers as shown on the geometry validation Tables will also be included. Each fit is shown from different orientation to approximate a three-dimensional view.

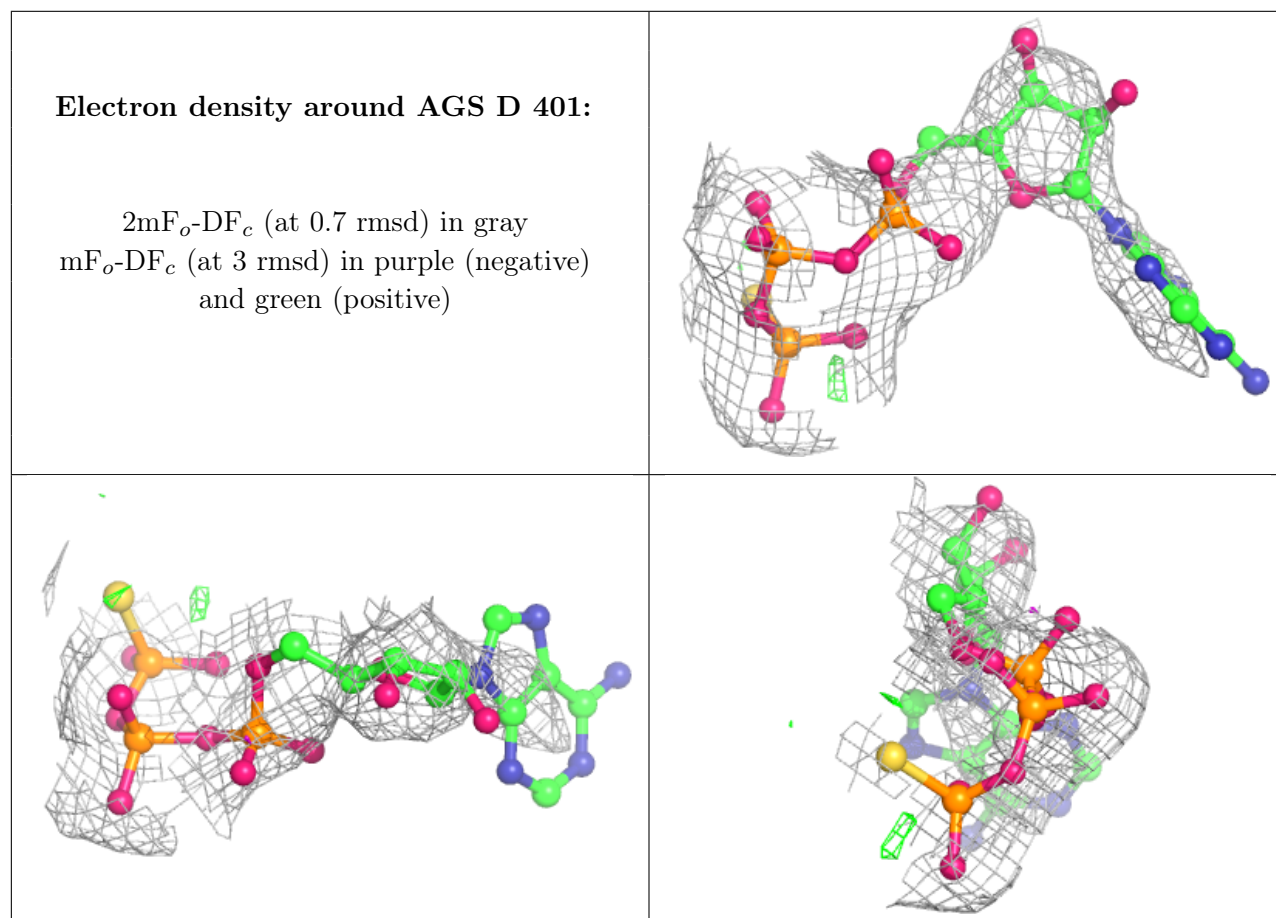

Electron density around AGS B 401:

$2mF_o-DF_c$ (at 0.7 rmsd) in gray
 mF_o-DF_c (at 3 rmsd) in purple (negative)
and green (positive)

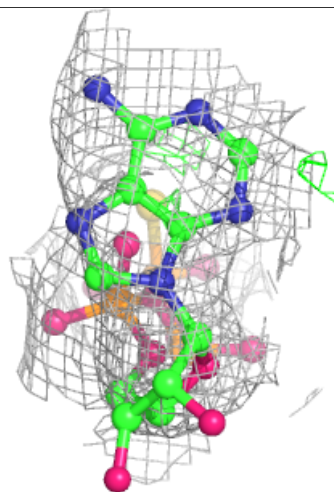
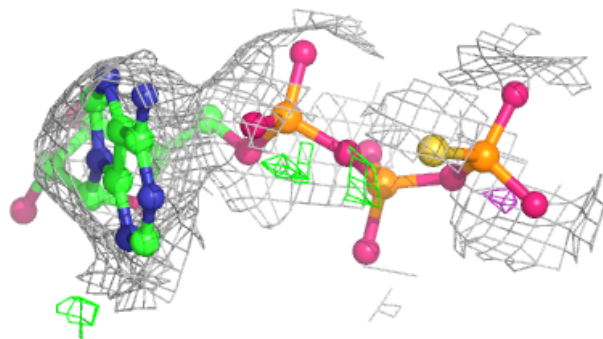
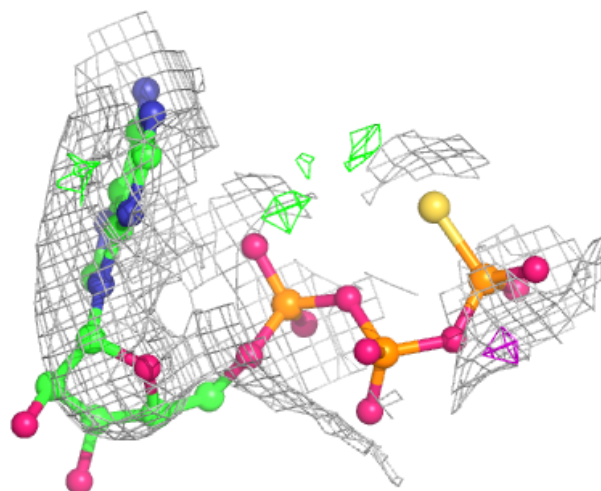

Electron density around AGS C 401:

$2mF_o-DF_c$ (at 0.7 rmsd) in gray
 mF_o-DF_c (at 3 rmsd) in purple (negative)
and green (positive)

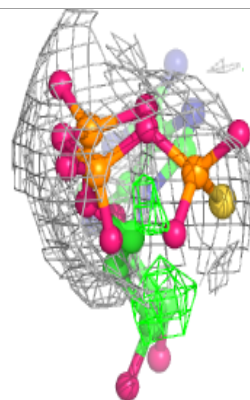
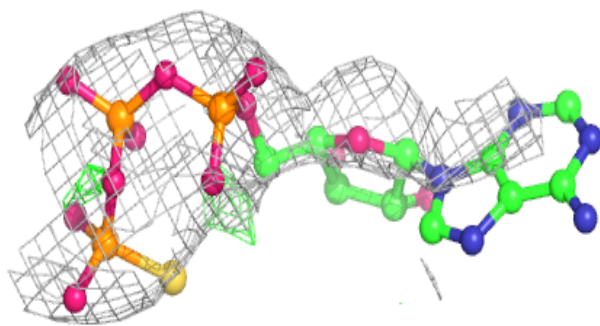
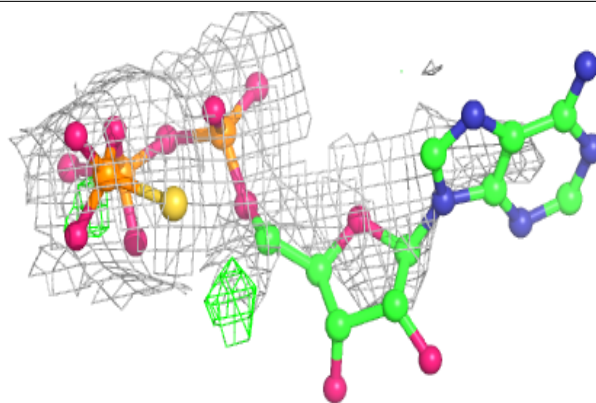
**Electron density around AGS F 401:**

$2mF_o-DF_c$ (at 0.7 rmsd) in gray
 mF_o-DF_c (at 3 rmsd) in purple (negative)
and green (positive)

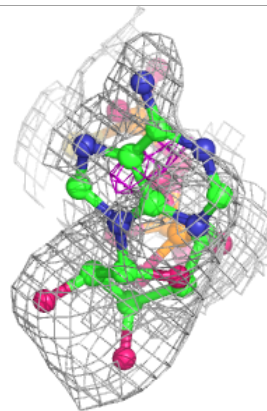
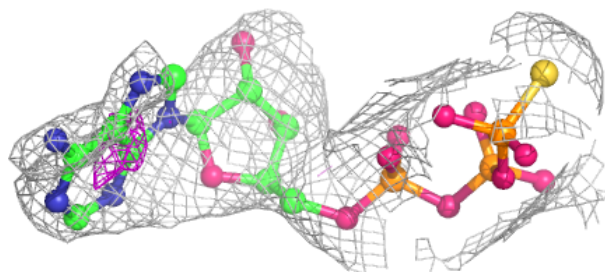
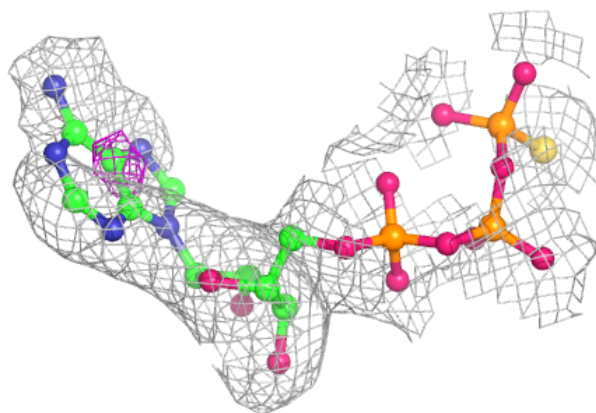

Electron density around AGS A 401:

$2mF_o-DF_c$ (at 0.7 rmsd) in gray
 mF_o-DF_c (at 3 rmsd) in purple (negative)
and green (positive)

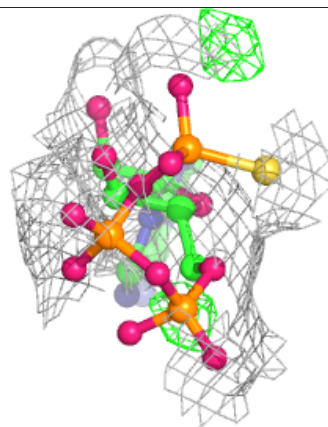
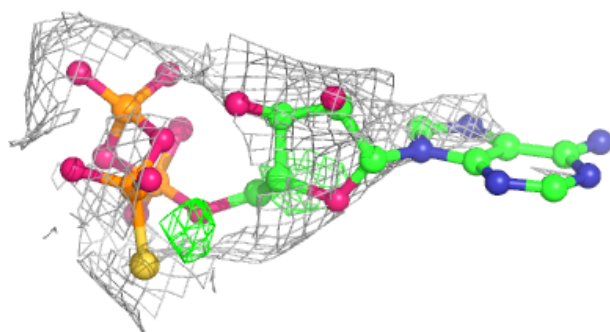
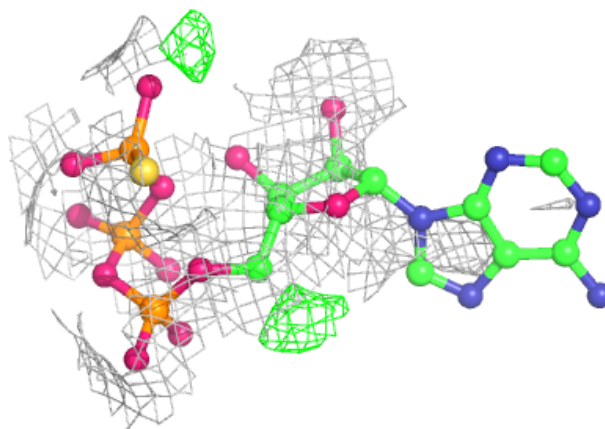
**Electron density around AGS E 401:**

$2mF_o-DF_c$ (at 0.7 rmsd) in gray
 mF_o-DF_c (at 3 rmsd) in purple (negative)
and green (positive)

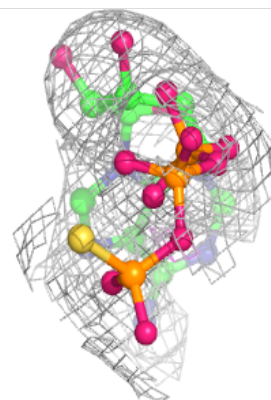
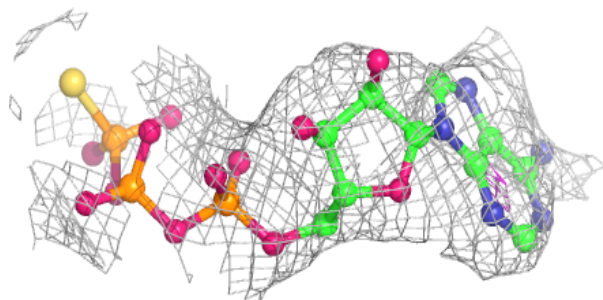
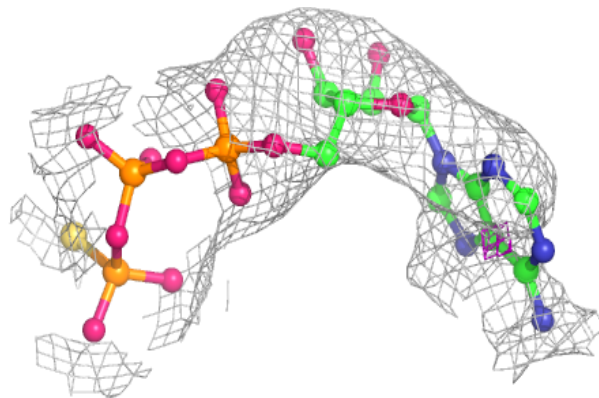

6.5 Other polymers [i](#)

There are no such residues in this entry.