



## Full wwPDB EM Validation Report ⓘ

Dec 26, 2024 – 10:01 AM EST

PDB ID : 6O9L  
EMDB ID : EMD-3307  
Title : Human holo-PIC in the closed state  
Authors : Yan, C.L.; Dodd, T.; He, Y.; Tainer, J.A.; Tsutakawa, S.E.; Ivanov, I.  
Deposited on : 2019-03-14  
Resolution : 7.20 Å (reported)

This is a Full wwPDB EM Validation Report for a publicly released PDB entry.

We welcome your comments at [validation@mail.wwpdb.org](mailto:validation@mail.wwpdb.org)

A user guide is available at

<https://www.wwpdb.org/validation/2017/EMValidationReportHelp>

with specific help available everywhere you see the ⓘ symbol.

The types of validation reports are described at

<http://www.wwpdb.org/validation/2017/FAQs#types>.

---

The following versions of software and data (see [references ⓘ](#)) were used in the production of this report:

EMDB validation analysis : 0.0.1.dev113  
Mogul : 2022.3.0, CSD as543be (2022)  
MolProbity : 4.02b-467  
Percentile statistics : 20231227.v01 (using entries in the PDB archive December 27th 2023)  
MapQ : 1.9.13  
Ideal geometry (proteins) : Engh & Huber (2001)  
Ideal geometry (DNA, RNA) : Parkinson et al. (1996)  
Validation Pipeline (wwPDB-VP) : 2.40

# 1 Overall quality at a glance

The following experimental techniques were used to determine the structure:

*ELECTRON MICROSCOPY*

The reported resolution of this entry is 7.20 Å.

Percentile scores (ranging between 0-100) for global validation metrics of the entry are shown in the following graphic. The table shows the number of entries on which the scores are based.

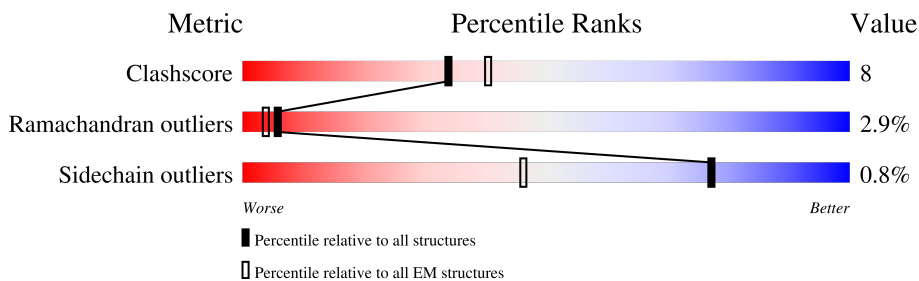

Metric	Whole archive (#Entries)	EM structures (#Entries)
Clashscore	210492	15764
Ramachandran outliers	207382	16835
Sidechain outliers	206894	16415

The table below summarises the geometric issues observed across the polymeric chains and their fit to the map. The red, orange, yellow and green segments of the bar indicate the fraction of residues that contain outliers for  $\geq 3$ , 2, 1 and 0 types of geometric quality criteria respectively. A grey segment represents the fraction of residues that are not modelled. The numeric value for each fraction is indicated below the corresponding segment, with a dot representing fractions  $\leq 5\%$ . The upper red bar (where present) indicates the fraction of residues that have poor fit to the EM map (all-atom inclusion  $< 40\%$ ). The numeric value is given above the bar.

Mol	Chain	Length	Quality of chain
1	A	1970	
2	B	1174	
3	C	275	
4	D	142	
5	E	210	
6	F	127	
7	G	172	
8	H	150	

Continued on next page...

Continued from previous page...

Mol	Chain	Length	Quality of chain
9	I	125	17% 86% 12%
10	J	67	76% 22%
11	K	117	6% 85% 15%
12	L	58	67% 10% 21%
13	M	316	26% 74% 22%
14	N	376	6% 24% 6% 70%
15	O	109	12% 77% 14% 9%
16	P	339	44% 10% 45%
17	Q	439	65% 82% 14%
18	R	291	13% 51% 6% 42%
19	S	517	17% 26% 6% 66%
20	T	249	28% 79% 16% 5%
21	U	301	17% 47% 8% 44%
22	0	760	33% 68% 25%
23	1	548	76% 79% 19%
24	2	462	53% 74% 23%
25	3	309	81% 79% 18%
26	4	308	41% 77% 17%
27	5	71	66% 87% 6% 7%
28	6	395	31% 71% 25%
29	7	782	38% 61% 18% 19%
30	8	346	86% 63% 22% 14%
31	9	323	85% 75% 10% 15%
32	X	65	9% 82% 18%
33	Y	65	5% 85% 15%

## 2 Entry composition [i](#)

There are 36 unique types of molecules in this entry. The entry contains 81800 atoms, of which 0 are hydrogens and 0 are deuteriums.

In the tables below, the AltConf column contains the number of residues with at least one atom in alternate conformation and the Trace column contains the number of residues modelled with at most 2 atoms.

- Molecule 1 is a protein called DNA-directed RNA polymerase II subunit RPB1.

Mol	Chain	Residues	Atoms					AltConf	Trace
			Total	C	N	O	S		
1	A	1476	11693	7341	2085	2193	74	0	0

- Molecule 2 is a protein called DNA-directed RNA polymerase II subunit RPB2.

Mol	Chain	Residues	Atoms					AltConf	Trace
			Total	C	N	O	S		
2	B	1165	9317	5878	1637	1738	64	0	0

- Molecule 3 is a protein called DNA-directed RNA polymerase II subunit RPB3.

Mol	Chain	Residues	Atoms					AltConf	Trace
			Total	C	N	O	S		
3	C	275	2213	1386	380	440	7	0	0

- Molecule 4 is a protein called DNA-directed RNA polymerase II subunit RPB4.

Mol	Chain	Residues	Atoms					AltConf	Trace
			Total	C	N	O	S		
4	D	129	1062	665	179	214	4	0	0

- Molecule 5 is a protein called DNA-directed RNA polymerase II subunit RPB5.

Mol	Chain	Residues	Atoms					AltConf	Trace
			Total	C	N	O	S		
5	E	210	1723	1088	301	325	9	0	0

- Molecule 6 is a protein called DNA-directed RNA polymerases I, II, and III subunit RPABC2.

Mol	Chain	Residues	Atoms					AltConf	Trace
			Total	C	N	O	S		
6	F	86	689	437	120	127	5	0	0

- Molecule 7 is a protein called DNA-directed RNA polymerase II subunit RPB7.

Mol	Chain	Residues	Atoms					AltConf	Trace
			Total	C	N	O	S		
7	G	171	1351	875	219	249	8	0	0

- Molecule 8 is a protein called DNA-directed RNA polymerases I, II, and III subunit RPABC3.

Mol	Chain	Residues	Atoms					AltConf	Trace
			Total	C	N	O	S		
8	H	150	1205	764	196	239	6	0	0

- Molecule 9 is a protein called DNA-directed RNA polymerase II subunit RPB9.

Mol	Chain	Residues	Atoms					AltConf	Trace
			Total	C	N	O	S		
9	I	125	1013	626	177	198	12	0	0

- Molecule 10 is a protein called DNA-directed RNA polymerases I, II, and III subunit RPABC5.

Mol	Chain	Residues	Atoms					AltConf	Trace
			Total	C	N	O	S		
10	J	67	533	345	90	92	6	0	0

- Molecule 11 is a protein called DNA-directed RNA polymerase II subunit RPB11-a.

Mol	Chain	Residues	Atoms					AltConf	Trace
			Total	C	N	O	S		
11	K	117	936	603	154	177	2	0	0

- Molecule 12 is a protein called DNA-directed RNA polymerases I, II, and III subunit RPABC4.

Mol	Chain	Residues	Atoms					AltConf	Trace
			Total	C	N	O	S		
12	L	46	388	241	75	66	6	0	0

- Molecule 13 is a protein called Transcription initiation factor IIB.

Mol	Chain	Residues	Atoms					AltConf	Trace
			Total	C	N	O	S		
13	M	310	2391	1490	426	457	18	0	0

- Molecule 14 is a protein called Transcription initiation factor IIA subunit 1.

Mol	Chain	Residues	Atoms					AltConf	Trace
			Total	C	N	O	S		
14	N	113	930	585	152	189	4	0	0

- Molecule 15 is a protein called Transcription initiation factor IIA subunit 2.

Mol	Chain	Residues	Atoms					AltConf	Trace
			Total	C	N	O	S		
15	O	99	806	510	142	151	3	0	0

- Molecule 16 is a protein called TATA-box-binding protein.

Mol	Chain	Residues	Atoms					AltConf	Trace
			Total	C	N	O	S		
16	P	185	1462	946	257	252	7	0	0

- Molecule 17 is a protein called General transcription factor IIE subunit 1.

Mol	Chain	Residues	Atoms					AltConf	Trace
			Total	C	N	O	S		
17	Q	430	3398	2100	590	688	20	0	0

- Molecule 18 is a protein called Transcription initiation factor IIE subunit beta.

Mol	Chain	Residues	Atoms					AltConf	Trace
			Total	C	N	O	S		
18	R	168	1377	878	238	257	4	0	0

- Molecule 19 is a protein called General transcription factor IIF subunit 1.

Mol	Chain	Residues	Atoms					AltConf	Trace
			Total	C	N	O	S		
19	S	176	1461	921	268	268	4	0	0

- Molecule 20 is a protein called General transcription factor IIF subunit 2.

Mol	Chain	Residues	Atoms					AltConf	Trace
			Total	C	N	O	S		
20	T	237	1893	1192	341	357	3	0	0

- Molecule 21 is a protein called Transcription elongation factor A protein 1.

Mol	Chain	Residues	Atoms					AltConf	Trace
			Total	C	N	O	S		
21	U	170	1343	818	247	263	15	0	0

- Molecule 22 is a protein called TFIIF basal transcription factor complex helicase XPD subunit.

Mol	Chain	Residues	Atoms					AltConf	Trace
			Total	C	N	O	S		
22	0	732	5895	3766	1029	1072	28	0	0

- Molecule 23 is a protein called General transcription factor IIH subunit 1.

Mol	Chain	Residues	Atoms					AltConf	Trace
			Total	C	N	O	S		
23	1	546	4342	2727	762	832	21	0	0

- Molecule 24 is a protein called General transcription factor IIH subunit 4, p52.

Mol	Chain	Residues	Atoms					AltConf	Trace
			Total	C	N	O	S		
24	2	453	3613	2323	634	642	14	0	0

- Molecule 25 is a protein called CDK-activating kinase assembly factor MAT1.

Mol	Chain	Residues	Atoms					AltConf	Trace
			Total	C	N	O	S		
25	3	309	2513	1580	438	481	14	0	0

- Molecule 26 is a protein called General transcription factor IIH subunit 3.

Mol	Chain	Residues	Atoms					AltConf	Trace
			Total	C	N	O	S		
26	4	295	2307	1477	385	426	19	0	0

- Molecule 27 is a protein called General transcription factor IIH subunit 5.

Mol	Chain	Residues	Atoms					AltConf	Trace
			Total	C	N	O	S		
27	5	66	522	336	83	100	3	0	0

- Molecule 28 is a protein called General transcription factor IIH subunit 2.

Mol	Chain	Residues	Atoms					AltConf	Trace
			Total	C	N	O	S		
28	6	385	3024	1909	524	564	27	0	0

- Molecule 29 is a protein called TFIIH basal transcription factor complex helicase XPB subunit.

Mol	Chain	Residues	Atoms					AltConf	Trace
			Total	C	N	O	S		
29	7	634	5095	3247	881	937	30	0	0

- Molecule 30 is a protein called Cyclin-dependent kinase 7.

Mol	Chain	Residues	Atoms					AltConf	Trace
			Total	C	N	O	S		
30	8	299	2378	1535	406	426	11	0	0

- Molecule 31 is a protein called Cyclin-H.

Mol	Chain	Residues	Atoms					AltConf	Trace
			Total	C	N	O	S		
31	9	276	2241	1438	380	406	17	0	0

- Molecule 32 is a DNA chain called DNA (65-MER).

Mol	Chain	Residues	Atoms					AltConf	Trace
			Total	C	N	O	P		
32	X	65	1343	633	261	385	64	0	0

- Molecule 33 is a DNA chain called DNA (65-MER).

Mol	Chain	Residues	Atoms					AltConf	Trace
			Total	C	N	O	P		
33	Y	65	1316	625	236	391	64	0	0

- Molecule 34 is MAGNESIUM ION (three-letter code: MG) (formula: Mg).

Mol	Chain	Residues	Atoms		AltConf
34	A	1	Total	Mg	0
			1	1	
34	B	1	Total	Mg	0
			1	1	



- Molecule 35 is ZINC ION (three-letter code: ZN) (formula: Zn).

Mol	Chain	Residues	Atoms	AltConf
35	A	2	Total Zn 2 2	0
35	B	1	Total Zn 1 1	0
35	C	1	Total Zn 1 1	0
35	I	2	Total Zn 2 2	0
35	J	1	Total Zn 1 1	0
35	L	1	Total Zn 1 1	0
35	M	1	Total Zn 1 1	0
35	Q	1	Total Zn 1 1	0
35	U	1	Total Zn 1 1	0
35	3	2	Total Zn 2 2	0
35	4	1	Total Zn 1 1	0
35	6	3	Total Zn 3 3	0

- Molecule 36 is IRON/SULFUR CLUSTER (three-letter code: SF4) (formula: Fe<sub>4</sub>S<sub>4</sub>).

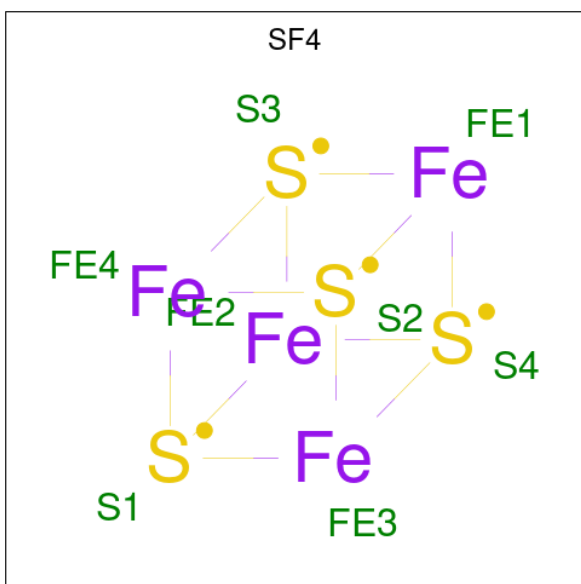

Mol	Chain	Residues	Atoms			AltConf
			Total	Fe	S	
36	0	1	8	4	4	0

### 3 Residue-property plots

These plots are drawn for all protein, RNA, DNA and oligosaccharide chains in the entry. The first graphic for a chain summarises the proportions of the various outlier classes displayed in the second graphic. The second graphic shows the sequence view annotated by issues in geometry and atom inclusion in map density. Residues are color-coded according to the number of geometric quality criteria for which they contain at least one outlier: green = 0, yellow = 1, orange = 2 and red = 3 or more. A red diamond above a residue indicates a poor fit to the EM map for this residue (all-atom inclusion < 40%). Stretches of 2 or more consecutive residues without any outlier are shown as a green connector. Residues present in the sample, but not in the model, are shown in grey.

- Molecule 1: DNA-directed RNA polymerase II subunit RPB1



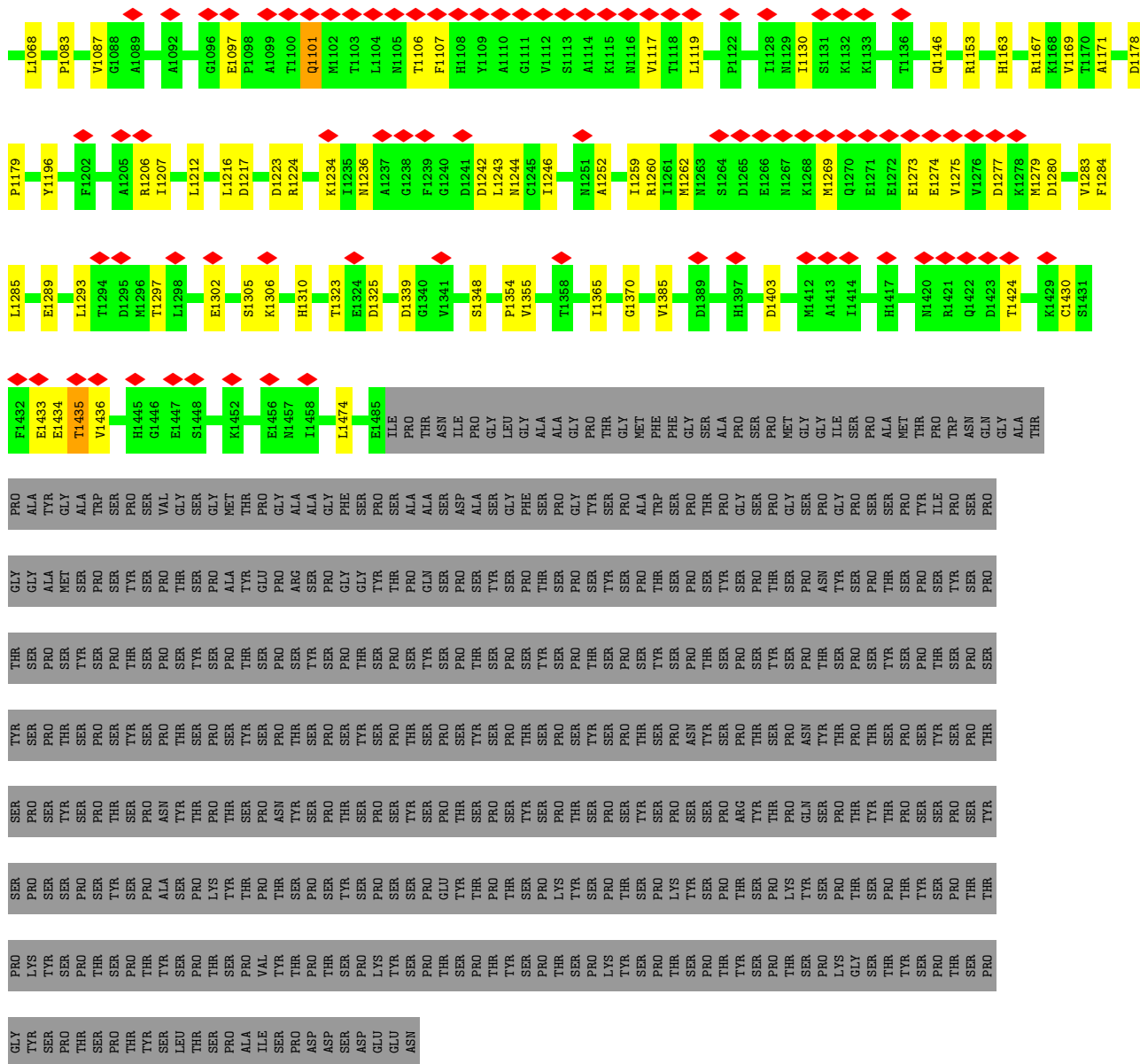

● Molecule 2: DNA-directed RNA polymerase II subunit RPB2

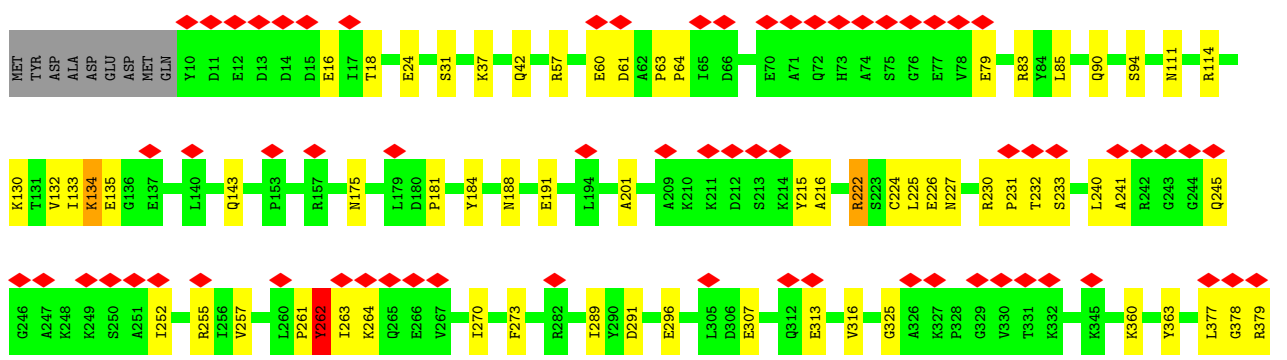
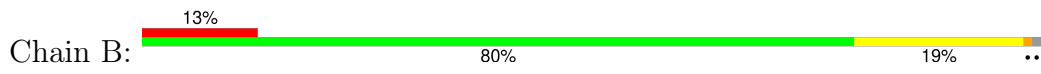

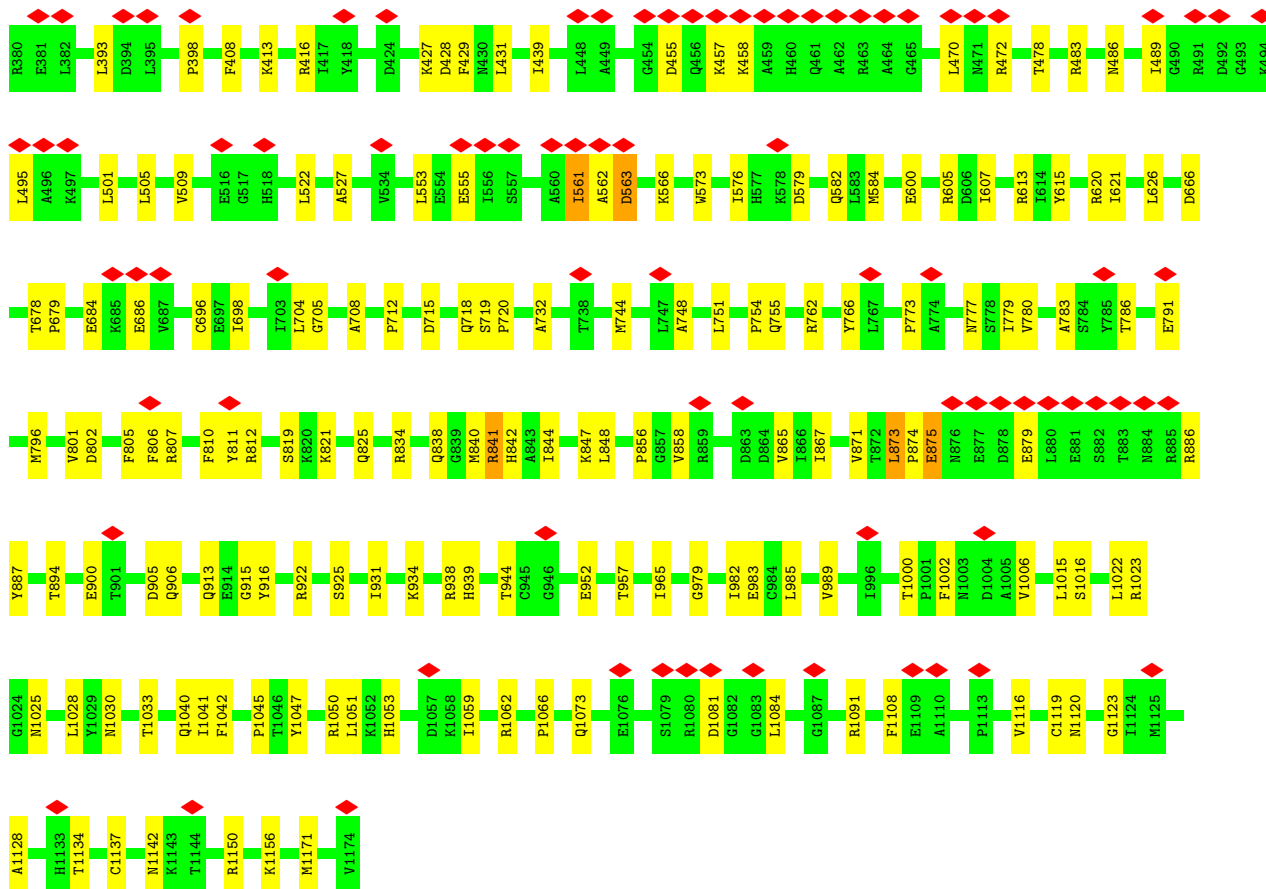

• Molecule 3: DNA-directed RNA polymerase II subunit RPB3

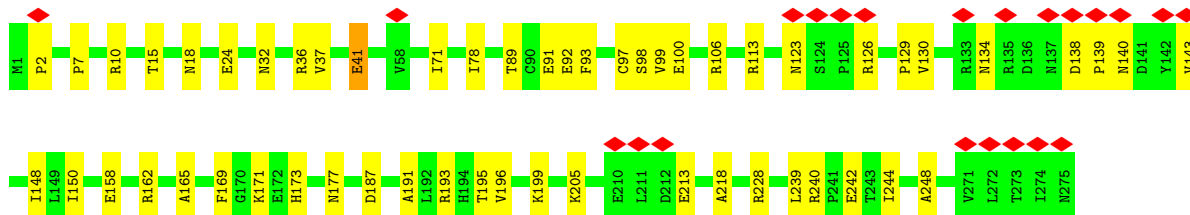
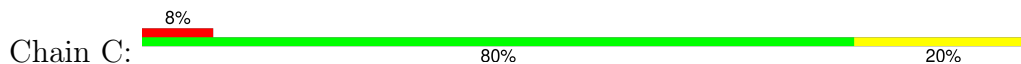

• Molecule 4: DNA-directed RNA polymerase II subunit RPB4

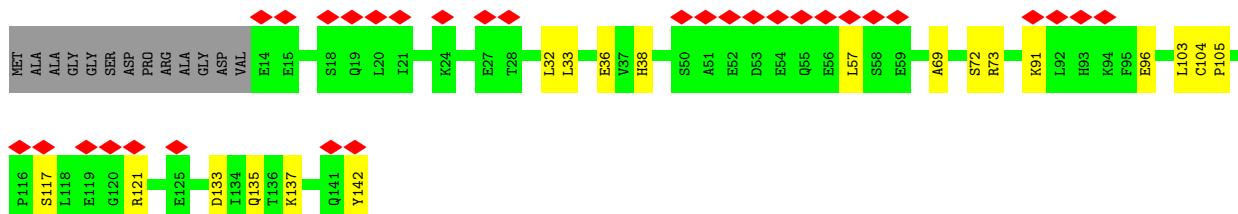
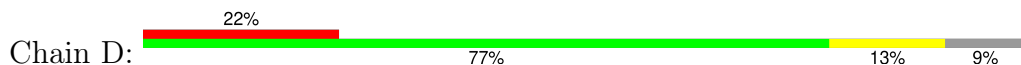

• Molecule 5: DNA-directed RNA polymerase II subunit RPB5

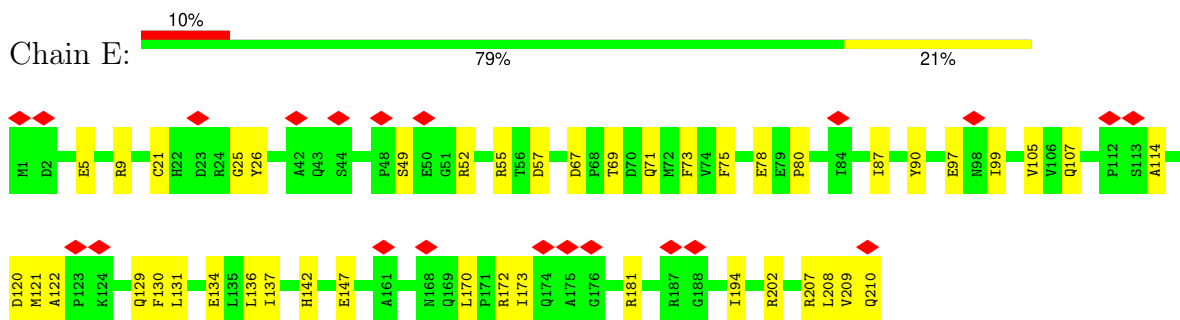

• Molecule 6: DNA-directed RNA polymerases I, II, and III subunit RPABC2

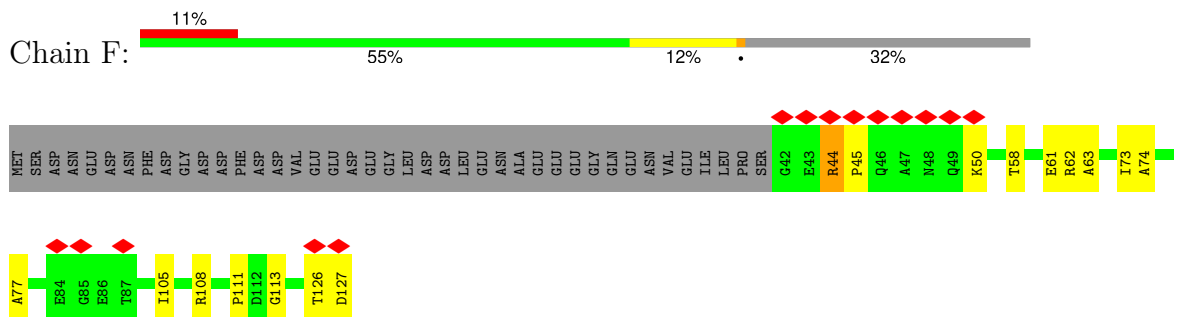

• Molecule 7: DNA-directed RNA polymerase II subunit RPB7

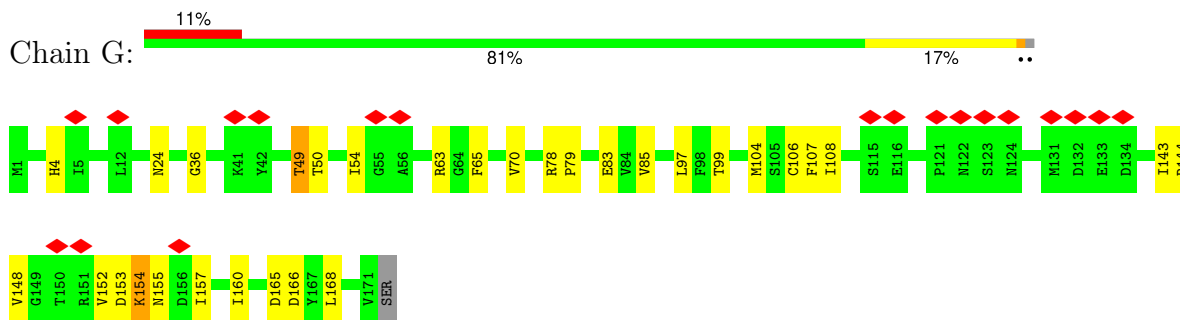

• Molecule 8: DNA-directed RNA polymerases I, II, and III subunit RPABC3

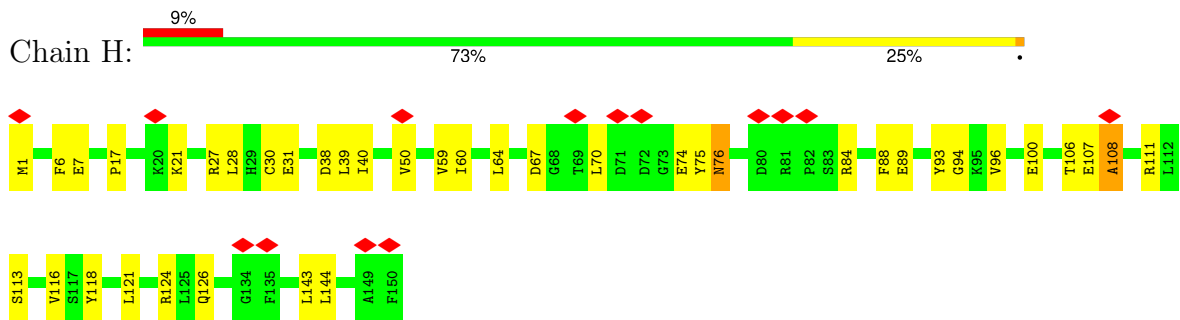

• Molecule 9: DNA-directed RNA polymerase II subunit RPB9

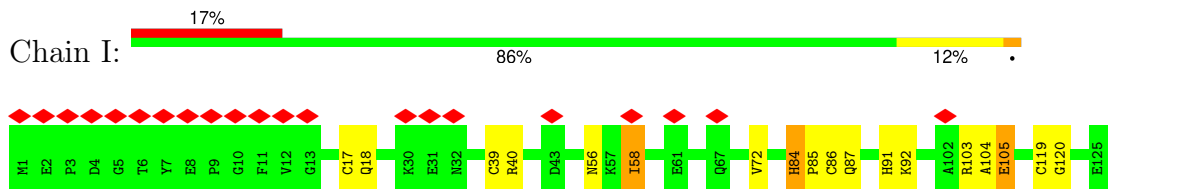

• Molecule 10: DNA-directed RNA polymerases I, II, and III subunit RPABC5

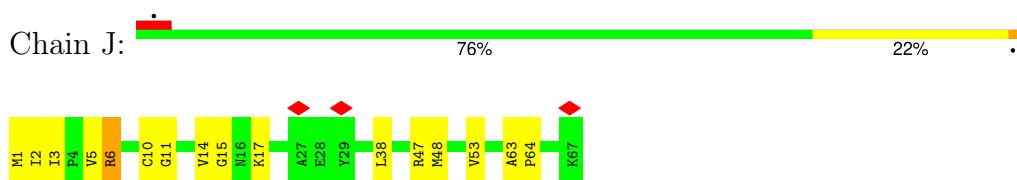

• Molecule 11: DNA-directed RNA polymerase II subunit RPB11-a

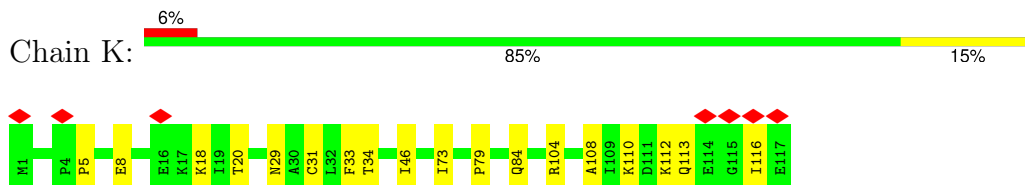

• Molecule 12: DNA-directed RNA polymerases I, II, and III subunit RPABC4

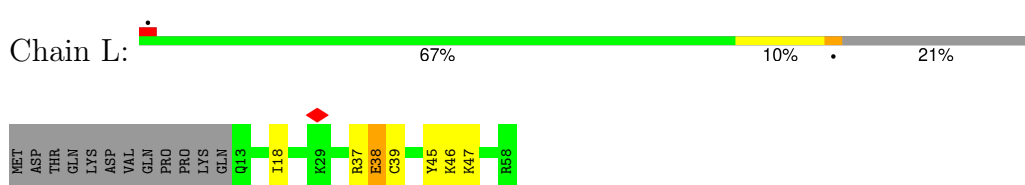

• Molecule 13: Transcription initiation factor IIB

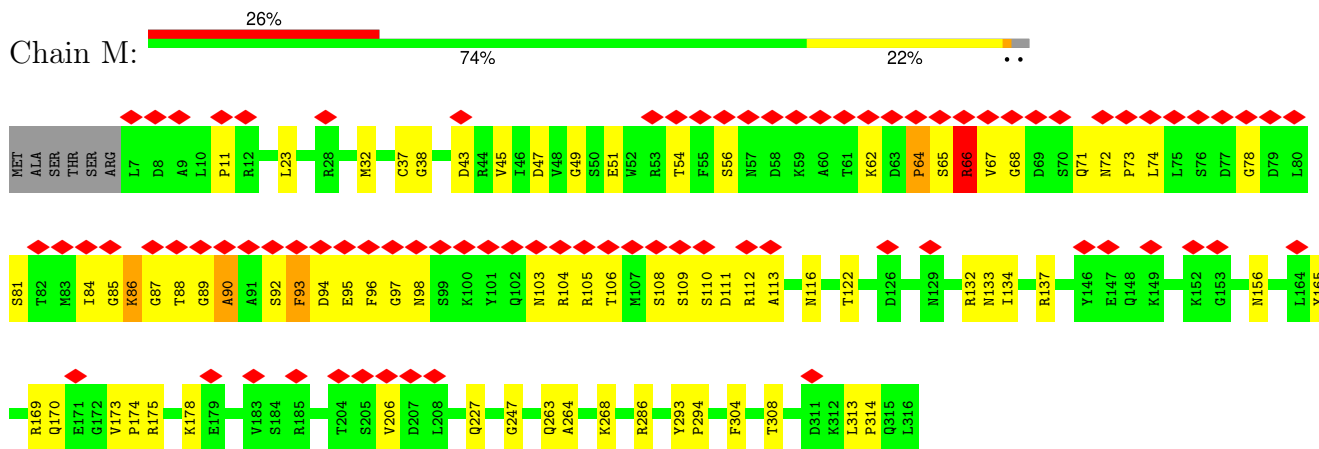

• Molecule 14: Transcription initiation factor IIA subunit 1

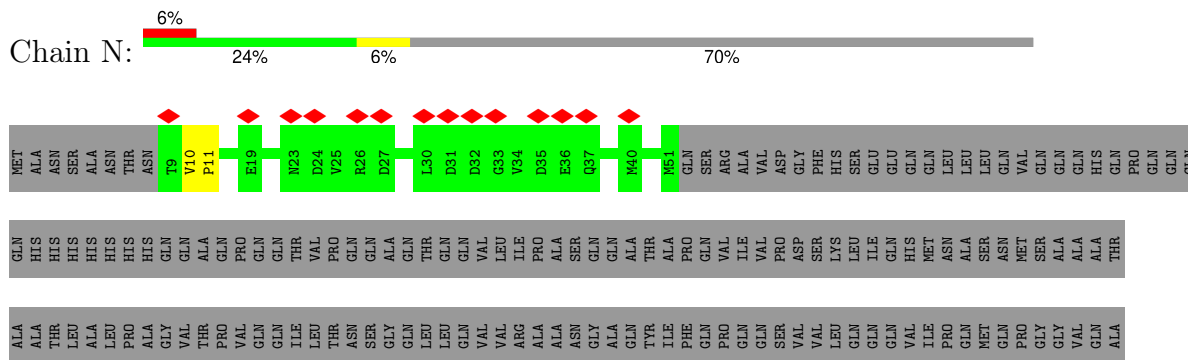







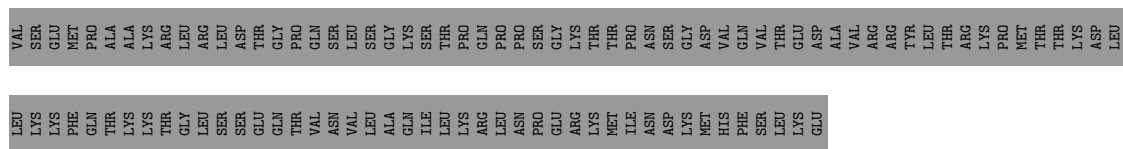

● Molecule 20: General transcription factor IIF subunit 2

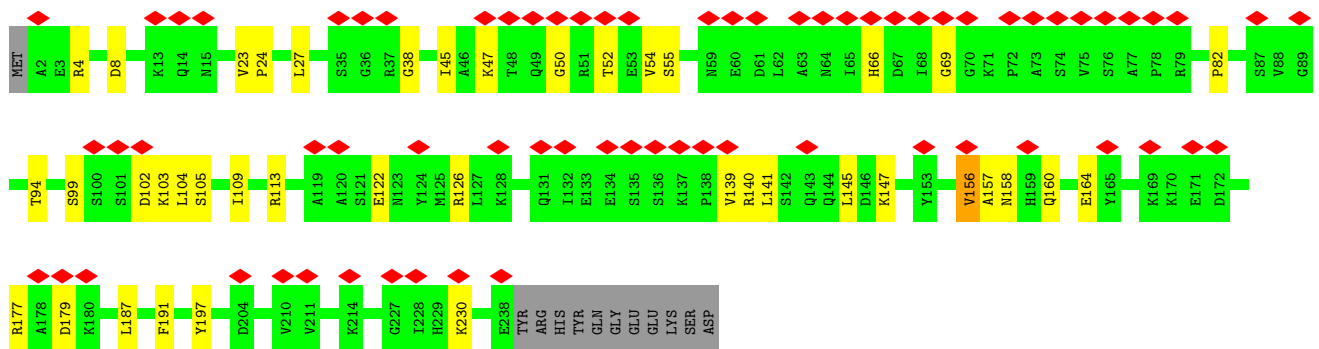
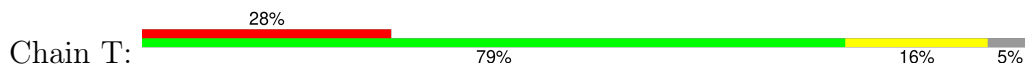

● Molecule 21: Transcription elongation factor A protein 1

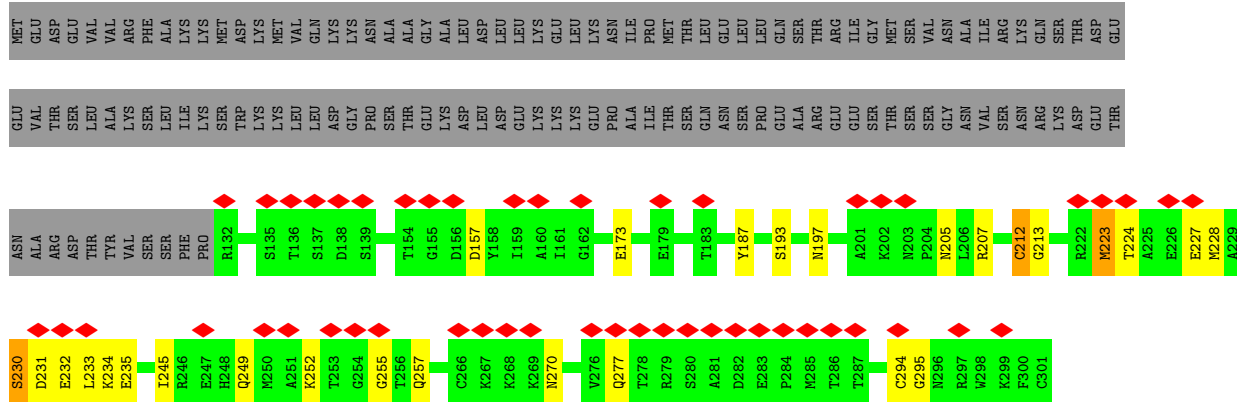

● Molecule 22: TFIIF basal transcription factor complex helicase XPD subunit

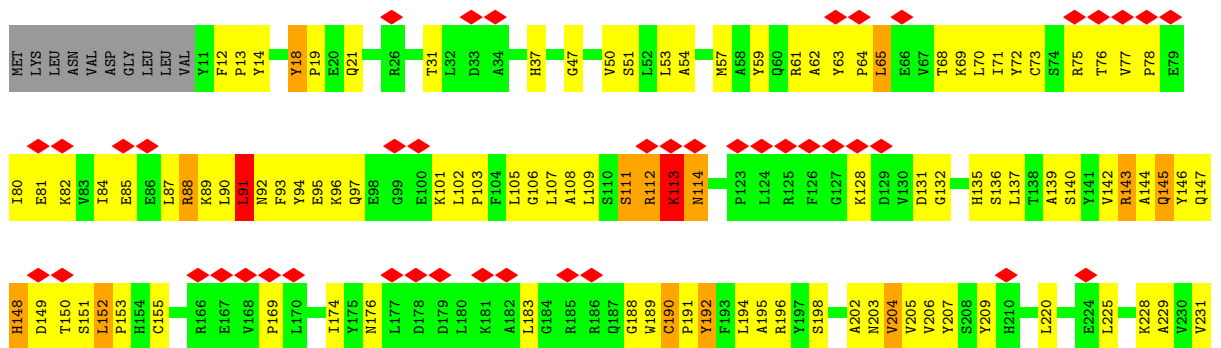

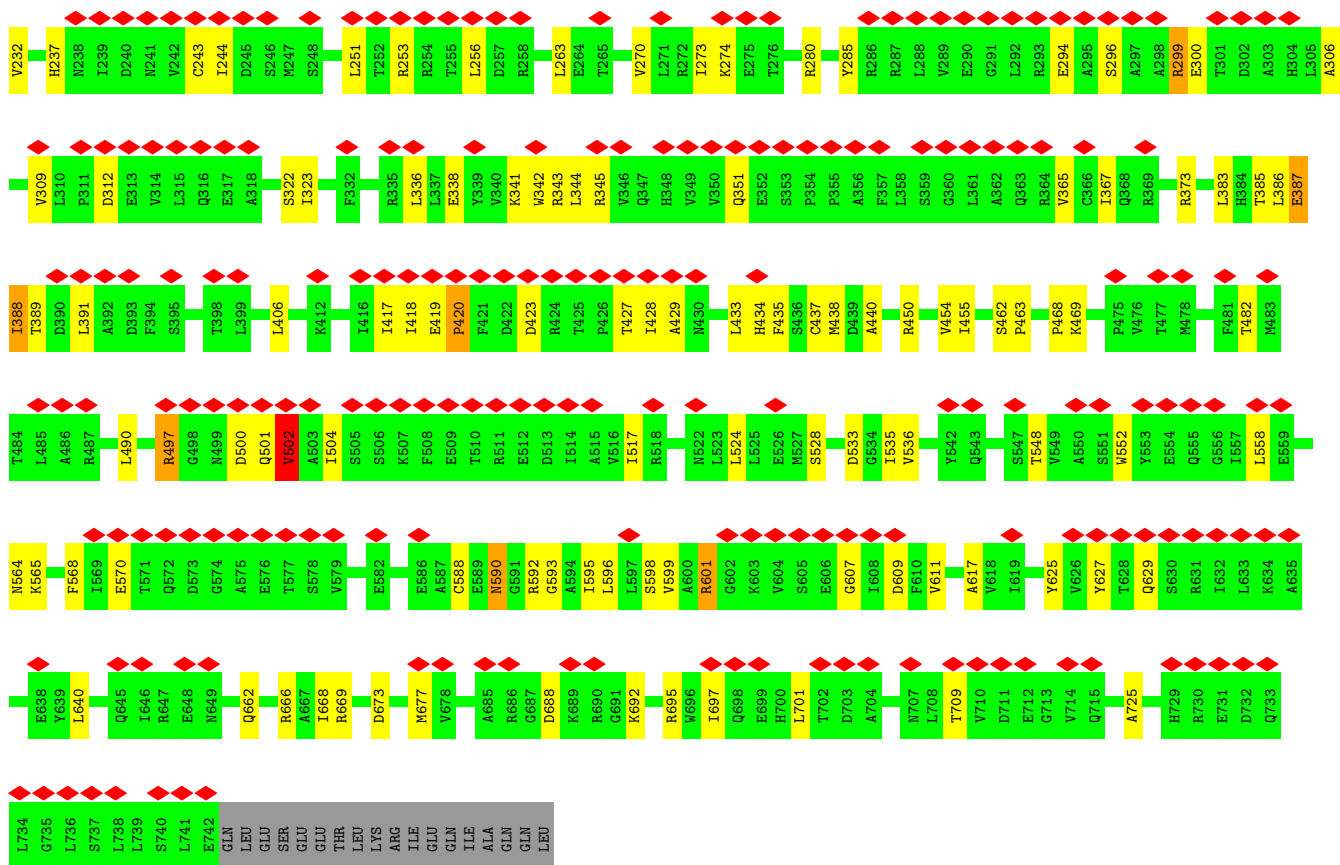

• Molecule 23: General transcription factor IIH subunit 1

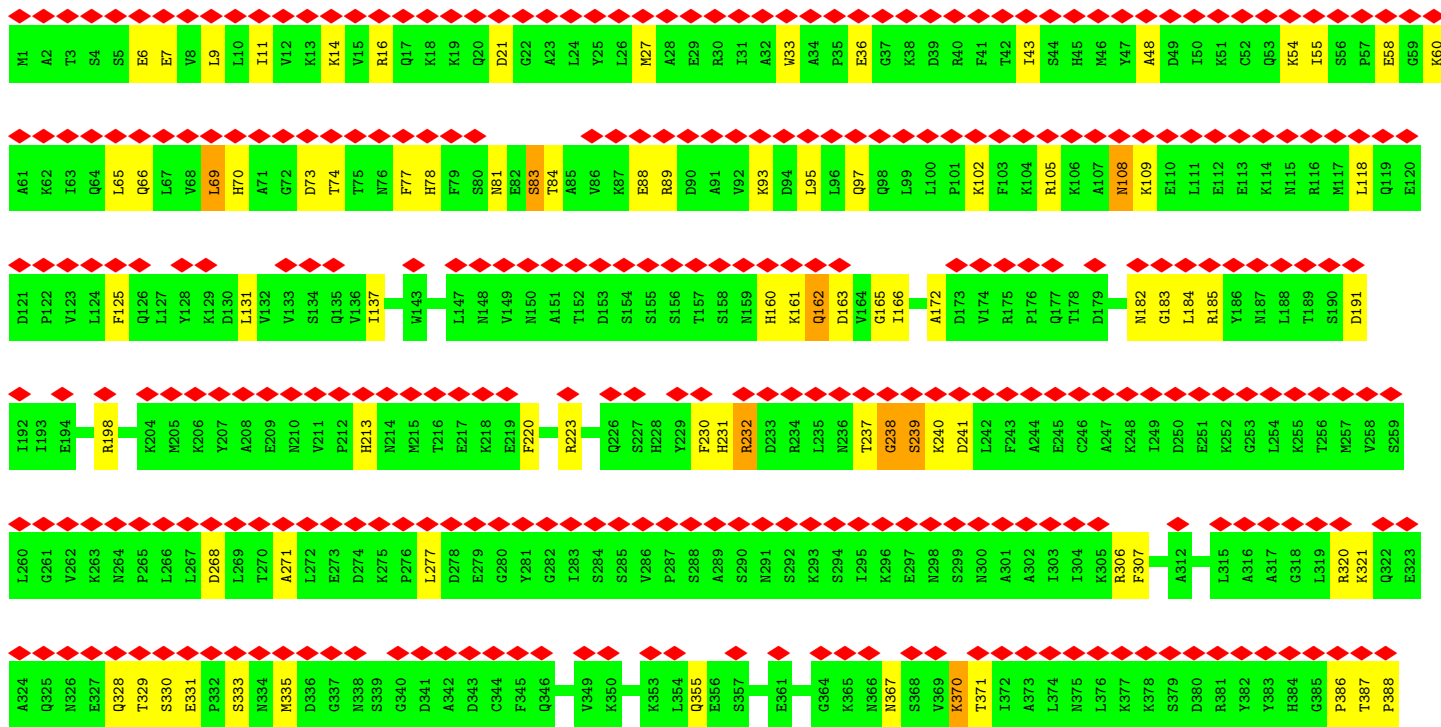
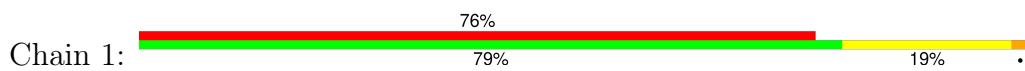

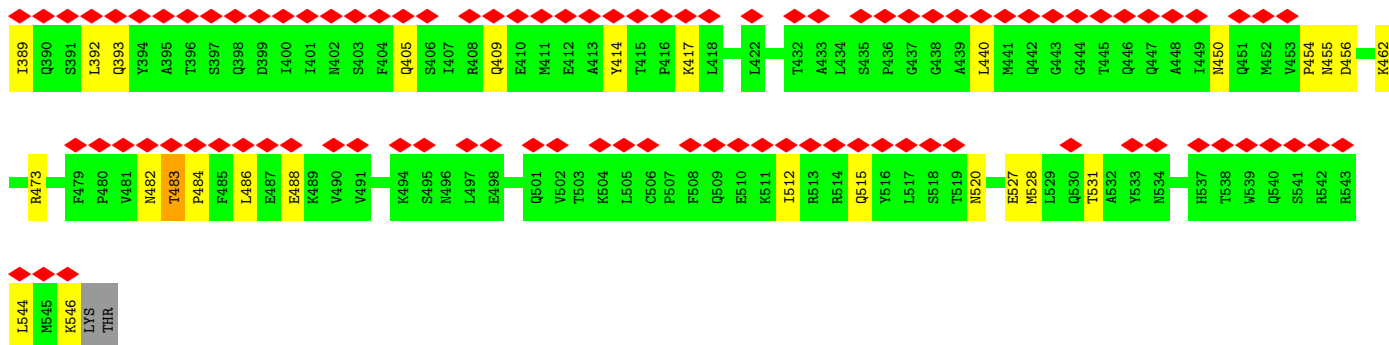

• Molecule 24: General transcription factor IIH subunit 4, p52

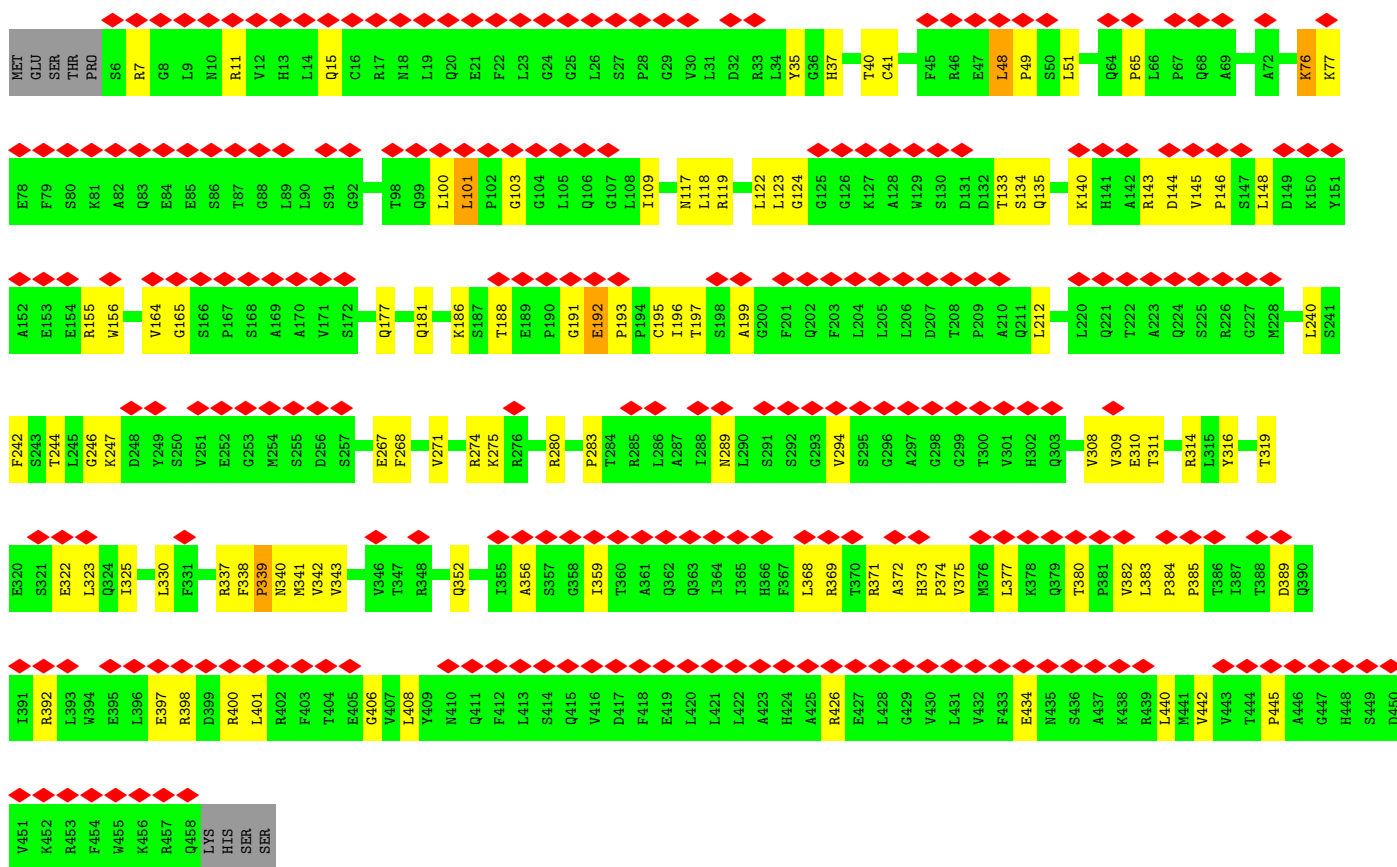

• Molecule 25: CDK-activating kinase assembly factor MAT1

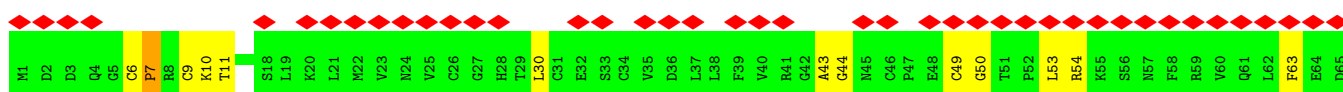
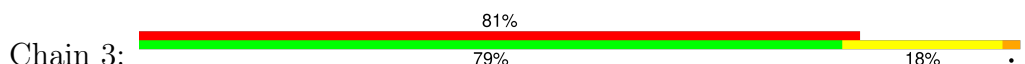

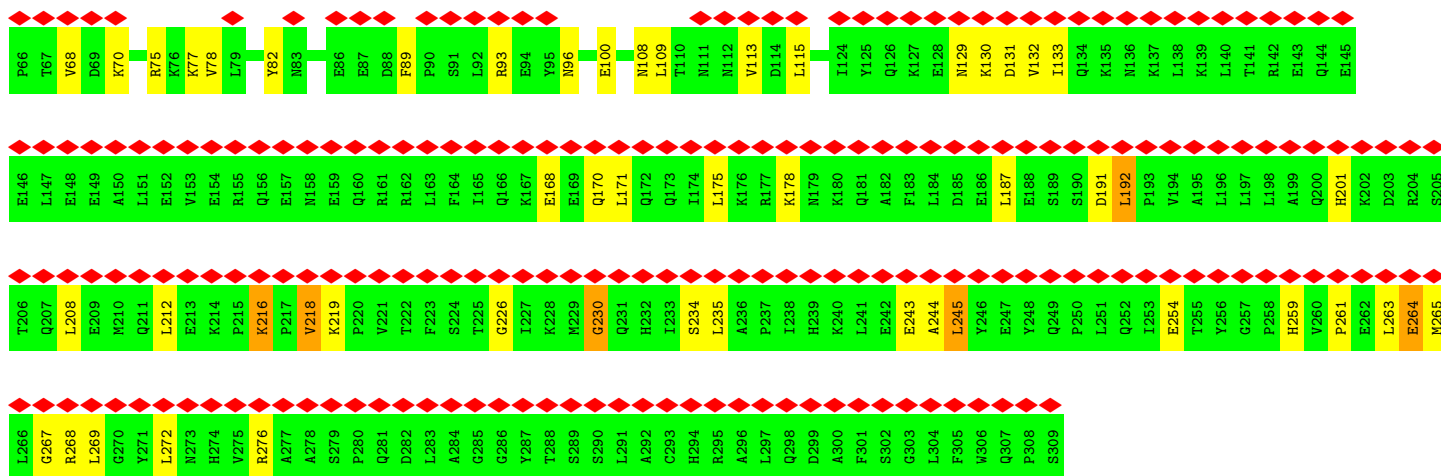

• Molecule 26: General transcription factor IIH subunit 3

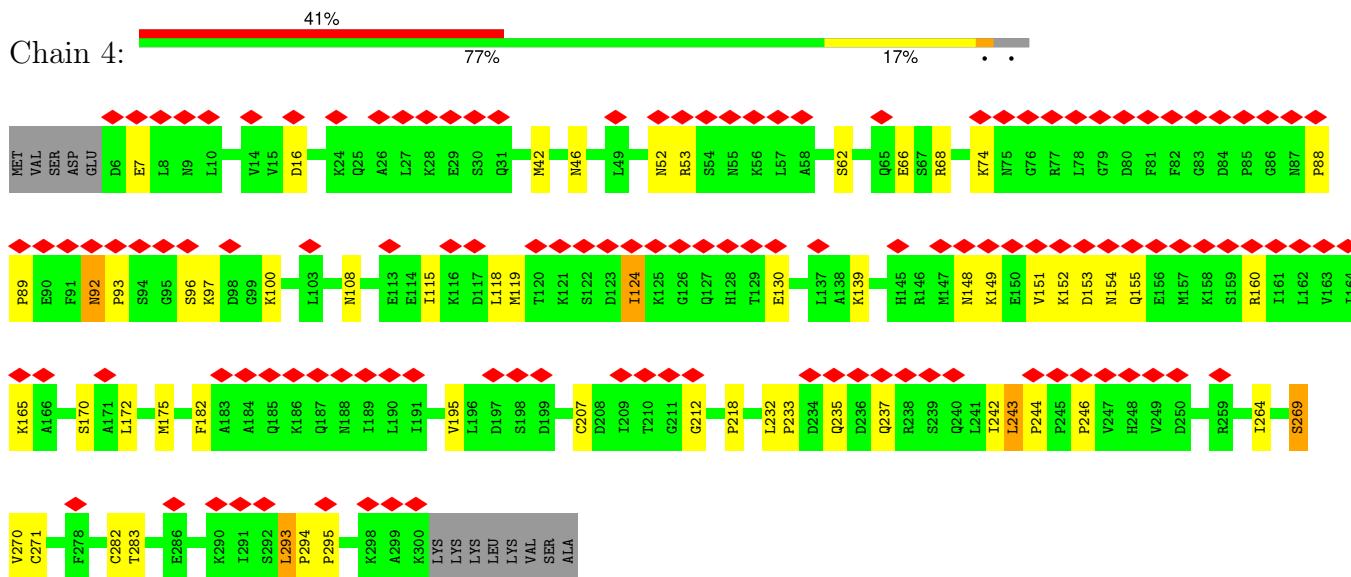

• Molecule 27: General transcription factor IIH subunit 5

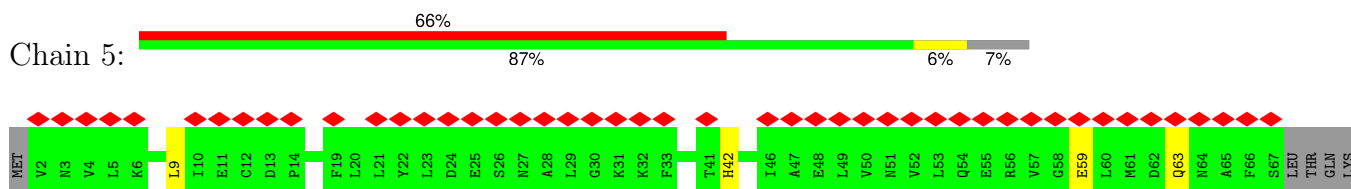

• Molecule 28: General transcription factor IIH subunit 2

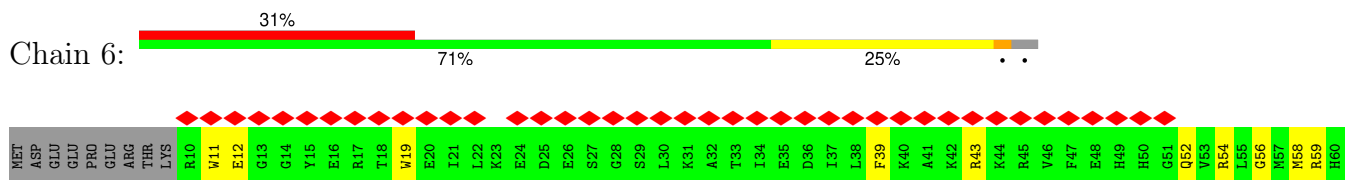

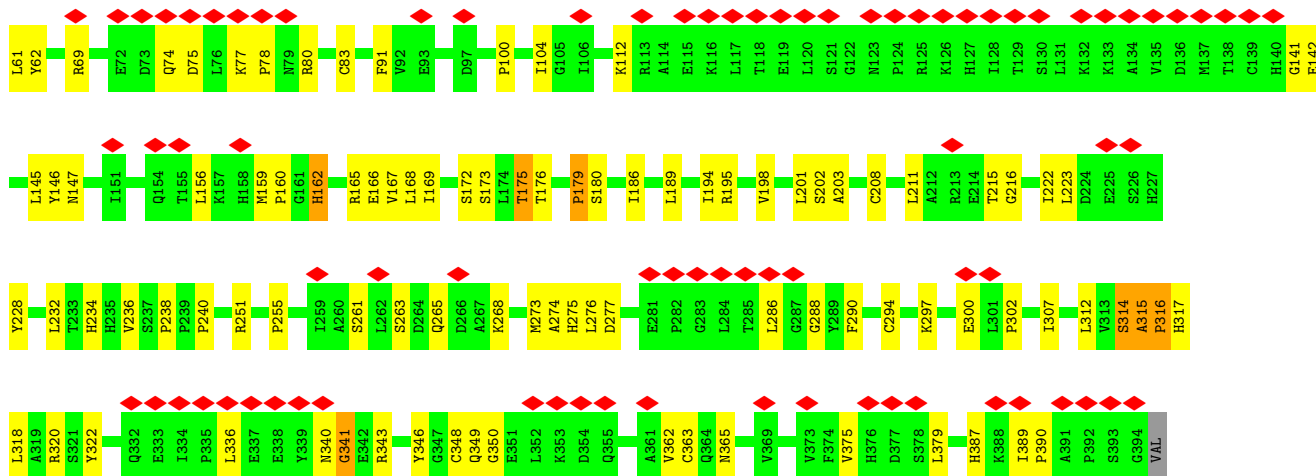

• Molecule 29: TFIID basal transcription factor complex helicase XPB subunit

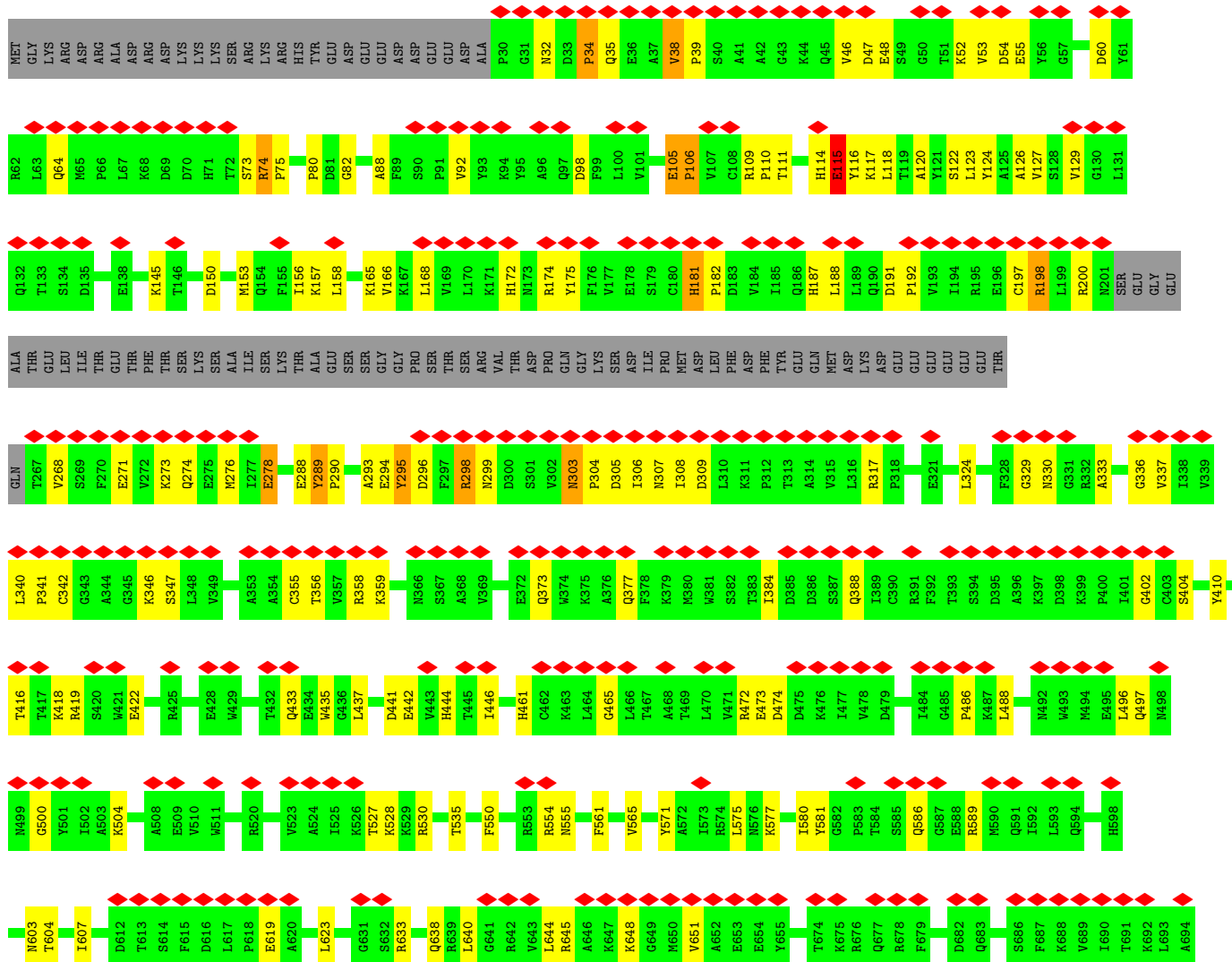

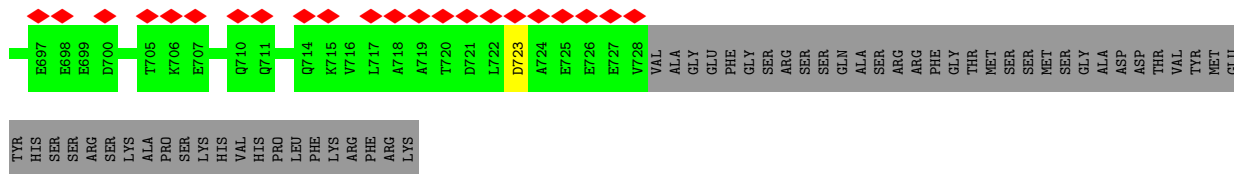

• Molecule 30: Cyclin-dependent kinase 7

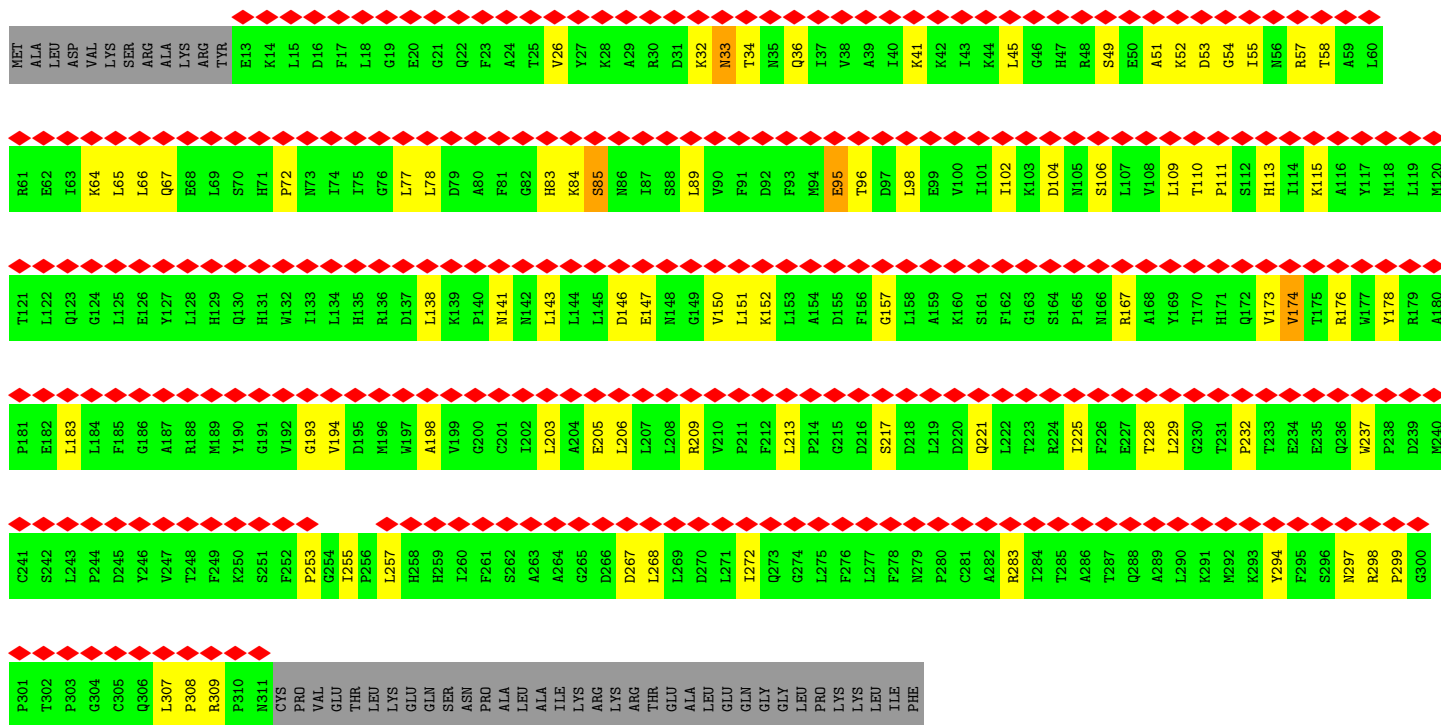
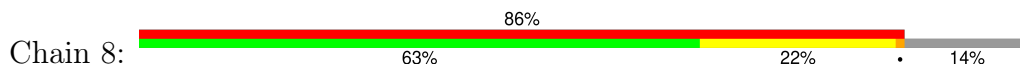

• Molecule 31: Cyclin-H

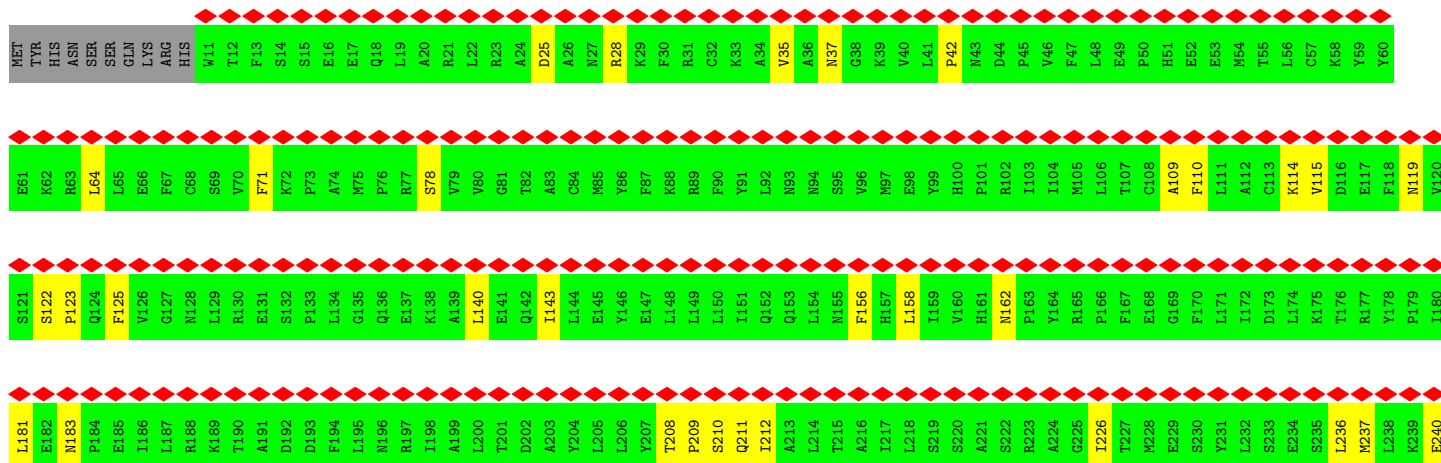
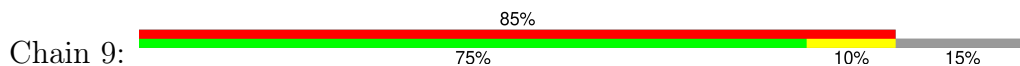

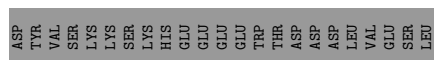
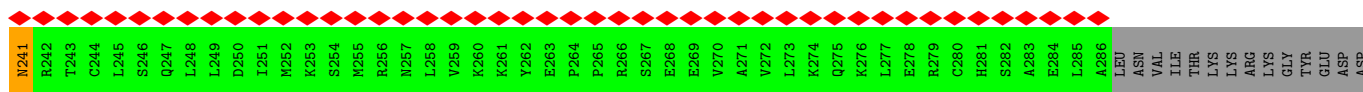

- Molecule 32: DNA (65-MER)

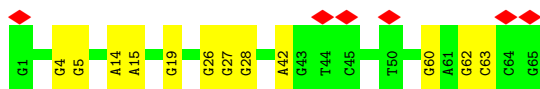
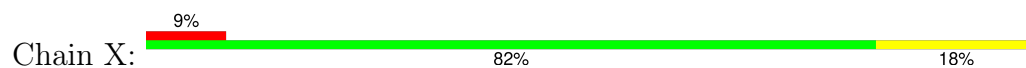

- Molecule 33: DNA (65-MER)

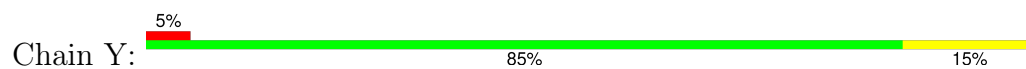



## 4 Experimental information

Property	Value	Source
EM reconstruction method	SINGLE PARTICLE	Depositor
Imposed symmetry	POINT, Not provided	
Number of particles used	24290	Depositor
Resolution determination method	Not provided	
CTF correction method	Not provided	
Microscope	FEI TITAN	Depositor
Voltage (kV)	300	Depositor
Electron dose ( $e^-/\text{\AA}^2$ )	46	Depositor
Minimum defocus (nm)	Not provided	
Maximum defocus (nm)	Not provided	
Magnification	Not provided	
Image detector	GATAN K2 SUMMIT (4k x 4k)	Depositor
Maximum map value	0.218	Depositor
Minimum map value	-0.111	Depositor
Average map value	0.001	Depositor
Map value standard deviation	0.007	Depositor
Recommended contour level	0.045	Depositor
Map size ( $\text{\AA}$ )	506.88, 506.88, 506.88	wwPDB
Map dimensions	192, 192, 192	wwPDB
Map angles ( $^\circ$ )	90.0, 90.0, 90.0	wwPDB
Pixel spacing ( $\text{\AA}$ )	2.64, 2.64, 2.64	Depositor

## 5 Model quality [i](#)

### 5.1 Standard geometry [i](#)

Bond lengths and bond angles in the following residue types are not validated in this section: ZN, SF4, MG

The Z score for a bond length (or angle) is the number of standard deviations the observed value is removed from the expected value. A bond length (or angle) with  $|Z| > 5$  is considered an outlier worth inspection. RMSZ is the root-mean-square of all Z scores of the bond lengths (or angles).

Mol	Chain	Bond lengths		Bond angles	
		RMSZ	# $ Z  > 5$	RMSZ	# $ Z  > 5$
1	A	0.23	0/11908	0.39	0/16076
2	B	0.23	0/9503	0.40	0/12831
3	C	0.22	0/2259	0.39	0/3073
4	D	0.23	0/1077	0.35	0/1446
5	E	0.22	0/1753	0.38	0/2368
6	F	0.23	0/700	0.38	0/946
7	G	0.25	0/1382	0.41	0/1874
8	H	0.24	0/1227	0.41	0/1654
9	I	0.23	0/1038	0.40	0/1407
10	J	0.23	0/542	0.39	0/730
11	K	0.23	0/955	0.37	0/1292
12	L	0.22	0/394	0.42	0/524
13	M	0.23	0/2429	0.40	0/3281
14	N	0.22	0/945	0.38	0/1274
15	O	0.23	0/816	0.38	0/1105
16	P	0.24	0/1489	0.41	0/2005
17	Q	0.23	0/3459	0.40	0/4670
18	R	0.22	0/1400	0.36	0/1880
19	S	0.24	0/1496	0.43	0/2013
20	T	0.23	0/1926	0.38	0/2595
21	U	0.23	0/1358	0.43	0/1820
22	0	0.45	1/6022 (0.0%)	0.62	4/8155 (0.0%)
23	1	0.23	0/4422	0.39	0/5964
24	2	0.24	0/3697	0.39	0/5011
25	3	0.23	0/2557	0.39	0/3444
26	4	0.24	0/2354	0.40	0/3189
27	5	0.23	0/528	0.37	0/713
28	6	0.23	0/3094	0.39	0/4188
29	7	0.23	0/5202	0.40	0/7029
30	8	0.23	0/2437	0.38	0/3306
31	9	0.23	0/2288	0.37	0/3091
32	X	0.45	0/1510	0.78	0/2332

Mol	Chain	Bond lengths		Bond angles	
		RMSZ	# Z  >5	RMSZ	# Z  >5
33	Y	0.45	0/1472	0.82	0/2267
All	All	0.26	1/83639 (0.0%)	0.44	4/113553 (0.0%)

Chiral center outliers are detected by calculating the chiral volume of a chiral center and verifying if the center is modelled as a planar moiety or with the opposite hand. A planarity outlier is detected by checking planarity of atoms in a peptide group, atoms in a mainchain group or atoms of a sidechain that are expected to be planar.

Mol	Chain	#Chirality outliers	#Planarity outliers
22	0	0	1

All (1) bond length outliers are listed below:

Mol	Chain	Res	Type	Atoms	Z	Observed(Å)	Ideal(Å)
22	0	155	CYS	C-N	5.02	1.45	1.34

All (4) bond angle outliers are listed below:

Mol	Chain	Res	Type	Atoms	Z	Observed(°)	Ideal(°)
22	0	89	LYS	N-CA-C	6.49	128.53	111.00
22	0	91	LEU	N-CA-CB	5.46	121.32	110.40
22	0	388	ILE	N-CA-C	-5.19	97.00	111.00
22	0	192	TYR	CZ-CE2-CD2	-5.17	115.15	119.80

There are no chirality outliers.

All (1) planarity outliers are listed below:

Mol	Chain	Res	Type	Group
22	0	18	TYR	Peptide

## 5.2 Too-close contacts [\(i\)](#)

In the following table, the Non-H and H(model) columns list the number of non-hydrogen atoms and hydrogen atoms in the chain respectively. The H(added) column lists the number of hydrogen atoms added and optimized by MolProbity. The Clashes column lists the number of clashes within the asymmetric unit, whereas Symm-Clashes lists symmetry-related clashes.

Mol	Chain	Non-H	H(model)	H(added)	Clashes	Symm-Clashes
1	A	11693	0	11776	179	0
2	B	9317	0	9311	156	0

*Continued on next page...*

*Continued from previous page...*

Mol	Chain	Non-H	H(model)	H(added)	Clashes	Symm-Clashes
3	C	2213	0	2155	24	0
4	D	1062	0	1042	11	0
5	E	1723	0	1745	24	0
6	F	689	0	715	12	0
7	G	1351	0	1358	19	0
8	H	1205	0	1168	21	0
9	I	1013	0	937	11	0
10	J	533	0	556	9	0
11	K	936	0	955	10	0
12	L	388	0	395	7	0
13	M	2391	0	2411	74	0
14	N	930	0	888	16	0
15	O	806	0	818	9	0
16	P	1462	0	1549	22	0
17	Q	3398	0	3264	37	0
18	R	1377	0	1402	12	0
19	S	1461	0	1429	50	0
20	T	1893	0	1928	22	0
21	U	1343	0	1339	14	0
22	0	5895	0	5921	278	0
23	1	4342	0	4346	107	0
24	2	3613	0	3657	59	0
25	3	2513	0	2518	37	0
26	4	2307	0	2334	38	0
27	5	522	0	528	3	0
28	6	3024	0	2994	71	0
29	7	5095	0	5127	80	0
30	8	2378	0	2397	51	0
31	9	2241	0	2279	22	0
32	X	1343	0	727	9	0
33	Y	1316	0	730	9	0
34	A	1	0	0	0	0
34	B	1	0	0	0	0
35	3	2	0	0	0	0
35	4	1	0	0	0	0
35	6	3	0	0	0	0
35	A	2	0	0	0	0
35	B	1	0	0	0	0
35	C	1	0	0	0	0
35	I	2	0	0	0	0
35	J	1	0	0	0	0
35	L	1	0	0	0	0

*Continued on next page...*

Continued from previous page...

Mol	Chain	Non-H	H(model)	H(added)	Clashes	Symm-Clashes
35	M	1	0	0	0	0
35	Q	1	0	0	0	0
35	U	1	0	0	0	0
36	0	8	0	0	0	0
All	All	81800	0	80699	1302	0

The all-atom clashscore is defined as the number of clashes found per 1000 atoms (including hydrogen atoms). The all-atom clashscore for this structure is 8.

All (1302) close contacts within the same asymmetric unit are listed below, sorted by their clash magnitude.

Atom-1	Atom-2	Interatomic distance (Å)	Clash overlap (Å)
22:0:59:TYR:CE2	22:0:68:THR:HG23	1.20	1.66
22:0:59:TYR:CE2	22:0:68:THR:CG2	1.76	1.60
22:0:77:VAL:CG1	23:1:268:ASP:HB2	1.34	1.51
23:1:223:ARG:HD3	23:1:237:THR:CG2	1.46	1.42
22:0:113:LYS:HD3	23:1:271:ALA:CB	1.47	1.42
22:0:57:MET:HB2	22:0:94:TYR:OH	1.20	1.36
22:0:59:TYR:CZ	22:0:68:THR:HG23	1.65	1.31
22:0:77:VAL:HG12	23:1:268:ASP:CB	1.62	1.29
22:0:77:VAL:CG1	23:1:268:ASP:CB	2.11	1.28
22:0:151:SER:O	22:0:153:PRO:CD	1.83	1.25
22:0:128:LYS:CE	23:1:277:LEU:HD21	1.67	1.23
22:0:142:VAL:HG13	22:0:152:LEU:CD1	1.71	1.18
22:0:59:TYR:CE2	22:0:68:THR:HG21	1.79	1.17
22:0:102:LEU:HD12	22:0:103:PRO:HD2	1.20	1.15
22:0:113:LYS:O	22:0:114:ASN:CG	1.85	1.13
22:0:147:GLN:HA	22:0:152:LEU:HD13	1.32	1.11
22:0:113:LYS:CD	23:1:271:ALA:HB2	1.80	1.10
22:0:137:LEU:HG	22:0:153:PRO:HG2	1.33	1.09
1:A:330:GLN:H	13:M:86:LYS:HG3	1.08	1.09
22:0:59:TYR:CE1	22:0:65:LEU:HD12	1.86	1.09
22:0:137:LEU:HD21	22:0:153:PRO:HB2	1.29	1.09
19:S:92:ARG:HG3	19:S:95:ASP:HB2	1.32	1.09
22:0:147:GLN:O	22:0:148:HIS:CD2	2.04	1.09
23:1:223:ARG:HD3	23:1:237:THR:HG22	1.36	1.08
23:1:223:ARG:HD3	23:1:237:THR:HG21	1.09	1.07
1:A:329:MET:HA	13:M:86:LYS:HD2	1.29	1.07
22:0:53:LEU:HD22	22:0:87:LEU:HD13	1.34	1.07
23:1:223:ARG:CD	23:1:237:THR:HG21	1.84	1.06
22:0:106:GLY:HA2	22:0:204:VAL:O	1.51	1.06

Continued on next page...

*Continued from previous page...*

Atom-1	Atom-2	Interatomic distance (Å)	Clash overlap (Å)
1:A:330:GLN:N	13:M:86:LYS:HG3	1.69	1.05
22:0:203:ASN:O	22:0:204:VAL:HG23	1.54	1.04
22:0:128:LYS:HE3	23:1:277:LEU:CD2	1.87	1.04
22:0:151:SER:O	22:0:153:PRO:HD3	0.87	1.03
22:0:102:LEU:CD1	22:0:103:PRO:HD2	1.87	1.03
22:0:203:ASN:O	22:0:204:VAL:CG2	2.06	1.03
22:0:128:LYS:HE3	23:1:277:LEU:HD21	1.04	1.03
22:0:147:GLN:O	22:0:148:HIS:HD2	1.40	1.02
22:0:95:GLU:HG3	22:0:101:LYS:HD3	1.41	1.01
22:0:142:VAL:HG13	22:0:152:LEU:HD11	1.42	1.01
22:0:142:VAL:HG12	22:0:142:VAL:O	1.59	0.99
22:0:53:LEU:HB2	22:0:90:LEU:HD22	1.38	0.99
22:0:77:VAL:HG12	23:1:268:ASP:HB3	1.44	0.98
1:A:330:GLN:H	13:M:86:LYS:CG	1.75	0.97
23:1:223:ARG:CD	23:1:237:THR:CG2	2.42	0.96
22:0:59:TYR:HE1	22:0:65:LEU:CD1	1.77	0.96
22:0:113:LYS:CD	23:1:271:ALA:CB	2.42	0.96
22:0:191:PRO:O	22:0:195:ALA:HB2	1.67	0.94
22:0:77:VAL:HG11	23:1:268:ASP:HB2	0.97	0.94
22:0:151:SER:C	22:0:153:PRO:HD3	1.87	0.94
22:0:53:LEU:CB	22:0:90:LEU:HD22	1.98	0.93
19:S:92:ARG:CG	19:S:95:ASP:HB2	1.99	0.92
22:0:59:TYR:CE1	22:0:65:LEU:CD1	2.52	0.92
22:0:57:MET:CB	22:0:94:TYR:OH	2.14	0.92
22:0:102:LEU:HD12	22:0:103:PRO:CD	2.00	0.91
22:0:189:TRP:O	22:0:190:CYS:O	1.87	0.91
2:B:262:TYR:CE2	2:B:263:ILE:HD13	2.06	0.91
22:0:59:TYR:CZ	22:0:68:THR:CG2	2.36	0.91
2:B:262:TYR:CE2	2:B:263:ILE:CD1	2.54	0.91
22:0:142:VAL:HG22	22:0:152:LEU:HG	1.51	0.90
22:0:113:LYS:O	22:0:114:ASN:ND2	2.04	0.90
19:S:92:ARG:HB2	19:S:95:ASP:H	1.36	0.89
2:B:262:TYR:CZ	2:B:263:ILE:HD13	2.07	0.89
22:0:128:LYS:CD	23:1:277:LEU:HD21	2.02	0.89
19:S:84:TYR:O	19:S:86:ILE:HG12	1.72	0.89
22:0:53:LEU:HD13	22:0:87:LEU:HA	1.53	0.88
22:0:113:LYS:HD3	23:1:271:ALA:HB2	0.88	0.88
22:0:12:PHE:CE1	22:0:90:LEU:HA	2.09	0.87
22:0:113:LYS:HD3	23:1:271:ALA:HB3	1.56	0.87
22:0:144:ALA:HB2	22:0:387:GLU:HG3	1.56	0.87
22:0:142:VAL:CG2	22:0:152:LEU:HG	2.03	0.86

*Continued on next page...*

*Continued from previous page...*

Atom-1	Atom-2	Interatomic distance (Å)	Clash overlap (Å)
22:0:77:VAL:HG11	23:1:268:ASP:CB	1.93	0.86
1:A:272:ASN:HD22	13:M:68:GLY:CA	1.89	0.86
22:0:142:VAL:O	22:0:142:VAL:CG1	2.25	0.85
1:A:329:MET:CA	13:M:86:LYS:HD2	2.07	0.85
19:S:91:PHE:HA	19:S:96:GLN:NE2	1.91	0.84
22:0:142:VAL:HG22	22:0:152:LEU:HA	1.59	0.83
19:S:92:ARG:HD2	19:S:95:ASP:OD2	1.79	0.83
22:0:113:LYS:NZ	23:1:271:ALA:HB3	1.94	0.82
22:0:69:LYS:HD2	22:0:229:ALA:HB2	1.60	0.82
22:0:142:VAL:HG13	22:0:152:LEU:HD12	1.61	0.81
13:M:94:ASP:HB2	13:M:98:ASN:HA	1.63	0.80
22:0:137:LEU:CG	22:0:153:PRO:HG2	2.11	0.80
2:B:718:GLN:HG2	2:B:720:PRO:HD2	1.63	0.80
22:0:183:LEU:HB3	22:0:188:GLY:HA3	1.64	0.79
22:0:12:PHE:HE1	22:0:90:LEU:HA	1.46	0.79
22:0:57:MET:HB2	22:0:94:TYR:HH	1.45	0.79
22:0:144:ALA:HB2	22:0:387:GLU:CG	2.13	0.78
2:B:262:TYR:CE2	2:B:263:ILE:HD11	2.20	0.76
29:7:289:TYR:H	29:7:290:PRO:HD2	1.51	0.76
22:0:77:VAL:HB	23:1:268:ASP:CG	2.05	0.76
22:0:113:LYS:HZ2	23:1:271:ALA:HB3	1.49	0.76
13:M:85:GLY:O	13:M:86:LYS:O	2.04	0.76
22:0:53:LEU:HD13	22:0:87:LEU:CA	2.17	0.75
22:0:95:GLU:HG3	22:0:101:LYS:CD	2.16	0.75
19:S:66:GLY:O	19:S:67:ALA:HB3	1.85	0.74
22:0:69:LYS:HD2	22:0:229:ALA:CB	2.18	0.74
22:0:144:ALA:CB	22:0:387:GLU:HG3	2.17	0.74
19:S:91:PHE:HA	19:S:96:GLN:HE21	1.52	0.73
22:0:191:PRO:O	22:0:195:ALA:CB	2.37	0.73
29:7:106:PRO:HG3	29:7:120:ALA:H	1.53	0.73
22:0:73:CYS:SG	22:0:209:TYR:HB3	2.28	0.73
22:0:139:ALA:HA	22:0:143:ARG:HG2	1.71	0.73
22:0:137:LEU:CD2	22:0:153:PRO:HB2	2.14	0.73
22:0:203:ASN:C	22:0:204:VAL:HG23	2.08	0.73
22:0:63:TYR:N	22:0:64:PRO:CD	2.51	0.73
2:B:261:PRO:O	2:B:263:ILE:N	2.21	0.72
19:S:92:ARG:HB3	19:S:93:PRO:HD2	1.72	0.72
19:S:84:TYR:O	19:S:86:ILE:N	2.23	0.71
19:S:56:ILE:HG13	19:S:89:LYS:HE3	1.73	0.71
22:0:113:LYS:NZ	23:1:268:ASP:OD1	2.22	0.71
13:M:94:ASP:CB	13:M:98:ASN:HA	2.20	0.71

*Continued on next page...*

*Continued from previous page...*

Atom-1	Atom-2	Interatomic distance (Å)	Clash overlap (Å)
22:0:152:LEU:O	22:0:152:LEU:HD23	1.90	0.71
22:0:59:TYR:CE2	22:0:68:THR:HG22	2.17	0.71
30:8:57:ARG:HH21	31:9:114:LYS:H	1.38	0.71
19:S:91:PHE:HD1	19:S:91:PHE:H	1.38	0.71
22:0:137:LEU:HG	22:0:153:PRO:CG	2.19	0.70
1:A:335:PRO:HG3	13:M:88:THR:HG21	1.72	0.70
24:2:382:VAL:HG12	24:2:384:PRO:HD2	1.72	0.70
22:0:59:TYR:CD2	22:0:68:THR:CG2	2.68	0.70
22:0:87:LEU:HD23	22:0:174:ILE:HD13	1.73	0.70
22:0:107:LEU:HD12	22:0:205:VAL:HG22	1.74	0.70
22:0:59:TYR:HE2	22:0:68:THR:CG2	1.45	0.70
22:0:142:VAL:HG22	22:0:152:LEU:CG	2.21	0.69
22:0:59:TYR:OH	22:0:68:THR:HG23	1.92	0.69
23:1:238:GLY:O	23:1:240:LYS:N	2.25	0.69
24:2:192:GLU:H	24:2:193:PRO:HD2	1.58	0.69
24:2:337:ARG:HH21	24:2:342:VAL:HG11	1.56	0.69
19:S:66:GLY:O	19:S:67:ALA:CB	2.40	0.69
22:0:147:GLN:CA	22:0:152:LEU:HD13	2.17	0.69
22:0:697:ILE:HA	22:0:701:LEU:HB2	1.73	0.69
8:H:74:GLU:O	8:H:76:ASN:N	2.26	0.69
1:A:330:GLN:N	13:M:86:LYS:CG	2.45	0.69
22:0:59:TYR:CD2	22:0:68:THR:HG21	2.27	0.69
19:S:92:ARG:HB2	19:S:95:ASP:N	2.07	0.68
26:4:293:LEU:H	26:4:294:PRO:HD2	1.59	0.68
22:0:53:LEU:HB2	22:0:90:LEU:CD2	2.18	0.68
22:0:88:ARG:NH1	22:0:174:ILE:O	2.27	0.68
19:S:91:PHE:O	19:S:92:ARG:O	2.12	0.68
22:0:91:LEU:HD23	22:0:92:ASN:N	2.09	0.67
19:S:73:ARG:O	19:S:74:LYS:HB2	1.93	0.67
1:A:272:ASN:HD22	13:M:68:GLY:HA2	1.59	0.67
22:0:136:SER:HA	22:0:140:SER:HB2	1.75	0.67
22:0:198:SER:O	22:0:202:ALA:HB2	1.95	0.67
22:0:203:ASN:O	22:0:204:VAL:HG22	1.94	0.67
18:R:140:LYS:H	18:R:141:PRO:HD2	1.58	0.67
22:0:192:TYR:CE2	22:0:299:ARG:NH1	2.63	0.67
9:I:119:CYS:SG	9:I:120:GLY:N	2.68	0.66
22:0:144:ALA:HB2	22:0:387:GLU:CD	2.14	0.66
22:0:146:TYR:O	22:0:147:GLN:HG2	1.95	0.66
2:B:1119:CYS:SG	2:B:1142:ASN:ND2	2.69	0.66
19:S:126:ILE:HB	19:S:138:PHE:HB2	1.78	0.66
22:0:59:TYR:HE2	22:0:68:THR:HG23	0.92	0.66

*Continued on next page...*



*Continued from previous page...*

Atom-1	Atom-2	Interatomic distance (Å)	Clash overlap (Å)
23:1:16:ARG:HB2	23:1:78:HIS:HB3	1.78	0.66
22:0:189:TRP:O	22:0:194:LEU:HB2	1.95	0.66
1:A:529:GLN:HE22	1:A:1097:GLU:HB3	1.60	0.66
1:A:329:MET:HB3	13:M:86:LYS:HB3	1.76	0.66
1:A:330:GLN:H	13:M:86:LYS:CD	2.07	0.65
22:0:142:VAL:HG22	22:0:152:LEU:CA	2.26	0.65
25:3:113:VAL:HG12	25:3:115:LEU:H	1.62	0.65
25:3:89:PHE:HB3	25:3:93:ARG:HE	1.61	0.65
13:M:37:CYS:SG	13:M:38:GLY:N	2.69	0.65
22:0:145:GLN:HB3	22:0:148:HIS:CE1	2.32	0.65
22:0:73:CYS:HA	22:0:207:TYR:O	1.97	0.64
1:A:330:GLN:CA	13:M:86:LYS:HG3	2.26	0.64
23:1:230:PHE:O	23:1:231:HIS:ND1	2.30	0.64
19:S:80:ARG:O	19:S:81:ARG:HB2	1.97	0.64
23:1:223:ARG:HB3	23:1:237:THR:HG21	1.79	0.64
22:0:113:LYS:O	22:0:114:ASN:OD1	2.16	0.64
29:7:373:GLN:O	29:7:377:GLN:NE2	2.30	0.64
29:7:38:VAL:H	29:7:39:PRO:HD2	1.62	0.64
1:A:330:GLN:C	13:M:86:LYS:HG3	2.17	0.64
12:L:37:ARG:O	12:L:39:CYS:N	2.31	0.64
30:8:110:THR:HB	30:8:113:HIS:HB2	1.80	0.64
32:X:4:DG:H1	33:Y:90:DC:H42	1.46	0.64
1:A:520:MET:HB3	1:A:522:PRO:HD2	1.80	0.63
13:M:103:ASN:HB3	13:M:105:ARG:HH22	1.62	0.63
22:0:183:LEU:O	22:0:188:GLY:N	2.30	0.63
28:6:363:CYS:SG	28:6:365:ASN:ND2	2.71	0.63
29:7:340:LEU:HD11	29:7:346:LYS:HA	1.80	0.63
2:B:262:TYR:CZ	2:B:263:ILE:CD1	2.78	0.63
23:1:9:LEU:HD22	23:1:95:LEU:HB3	1.80	0.63
23:1:370:LYS:HG2	23:1:371:THR:HG23	1.80	0.63
1:A:329:MET:SD	13:M:87:GLY:HA2	2.38	0.63
8:H:40:ILE:HD12	8:H:124:ARG:HD3	1.80	0.63
21:U:212:CYS:SG	21:U:213:GLY:N	2.71	0.63
7:G:153:ASP:O	7:G:155:ASN:N	2.32	0.62
8:H:94:GLY:HA3	8:H:118:TYR:HA	1.81	0.62
19:S:84:TYR:O	19:S:86:ILE:HG23	1.99	0.62
23:1:69:LEU:HD12	23:1:73:ASP:HB3	1.81	0.62
16:P:167:ASN:HB3	16:P:259:VAL:HB	1.80	0.62
30:8:32:LYS:O	30:8:34:THR:N	2.33	0.62
22:0:113:LYS:HE3	23:1:268:ASP:HA	1.80	0.62
31:9:208:THR:HG22	31:9:210:SER:H	1.65	0.62

*Continued on next page...*

*Continued from previous page...*

Atom-1	Atom-2	Interatomic distance (Å)	Clash overlap (Å)
23:1:405:GLN:O	23:1:409:GLN:NE2	2.33	0.62
2:B:261:PRO:O	2:B:263:ILE:HG12	2.00	0.61
2:B:489:ILE:HA	2:B:522:LEU:HD11	1.82	0.61
22:0:142:VAL:HG13	22:0:152:LEU:CG	2.29	0.61
1:A:1348:SER:HB3	5:E:136:LEU:HD23	1.83	0.61
22:0:135:HIS:NE2	22:0:300:GLU:HG2	2.15	0.61
28:6:52:GLN:HG3	28:6:240:PRO:HD3	1.82	0.61
13:M:65:SER:HB3	13:M:73:PRO:HA	1.82	0.61
28:6:156:LEU:HD21	28:6:165:ARG:HB2	1.82	0.61
1:A:331:LYS:HD3	13:M:104:ARG:HE	1.65	0.61
5:E:170:LEU:HD23	5:E:208:LEU:HB2	1.83	0.61
22:0:142:VAL:CG2	22:0:152:LEU:HA	2.29	0.61
29:7:165:LYS:HB2	29:7:294:GLU:HG2	1.83	0.61
25:3:269:LEU:HD21	30:8:51:ALA:HB3	1.82	0.61
26:4:68:ARG:HE	26:4:118:LEU:HD13	1.66	0.61
10:J:10:CYS:SG	10:J:11:GLY:N	2.69	0.61
22:0:128:LYS:CD	23:1:277:LEU:CD2	2.78	0.61
24:2:41:CYS:SG	26:4:53:ARG:NH2	2.74	0.60
22:0:688:ASP:OD1	22:0:692:LYS:NZ	2.35	0.60
26:4:243:LEU:H	26:4:244:PRO:HD2	1.65	0.60
29:7:342:CYS:SG	29:7:638:GLN:NE2	2.74	0.60
1:A:689:ILE:HG13	2:B:985:LEU:HD22	1.83	0.60
13:M:122:THR:HG23	13:M:132:ARG:HH12	1.66	0.60
19:S:84:TYR:O	19:S:85:GLY:C	2.37	0.60
28:6:189:LEU:HD22	28:6:194:ILE:HD11	1.83	0.60
29:7:355:CYS:HA	29:7:358:ARG:HH21	1.65	0.60
30:8:167:ARG:NH2	31:9:78:SER:OG	2.34	0.60
26:4:160:ARG:NH1	26:4:232:LEU:O	2.33	0.60
27:5:59:GLU:O	27:5:63:GLN:NE2	2.34	0.60
29:7:296:ASP:OD1	29:7:298:ARG:NH2	2.35	0.60
2:B:1137:CYS:HB3	2:B:1142:ASN:HB3	1.82	0.60
28:6:54:ARG:HG2	28:6:56:GLY:H	1.65	0.60
19:S:81:ARG:O	19:S:83:LYS:HG2	2.02	0.60
29:7:88:ALA:HB2	29:7:117:LYS:HG3	1.83	0.60
1:A:1036:ASN:HB2	5:E:202:ARG:HB3	1.83	0.60
2:B:458:LYS:HA	13:M:92:SER:OG	2.02	0.60
5:E:71:GLN:HE21	5:E:97:GLU:HG3	1.67	0.60
23:1:48:ALA:HB1	23:1:185:ARG:HA	1.82	0.60
2:B:483:ARG:NH2	2:B:527:ALA:O	2.33	0.60
3:C:177:ASN:HB3	10:J:6:ARG:HH22	1.67	0.60
3:C:10:ARG:NH2	3:C:24:GLU:OE2	2.35	0.60

*Continued on next page...*

*Continued from previous page...*

Atom-1	Atom-2	Interatomic distance (Å)	Clash overlap (Å)
28:6:198:VAL:HG21	28:6:208:CYS:HB3	1.83	0.60
1:A:172:ASP:OD2	1:A:177:LYS:NZ	2.35	0.59
8:H:17:PRO:HB3	8:H:27:ARG:HB3	1.85	0.59
24:2:247:LYS:HG3	24:2:280:ARG:HH21	1.66	0.59
26:4:160:ARG:HD2	26:4:235:GLN:HB3	1.84	0.59
22:0:21:GLN:HE21	22:0:51:SER:HA	1.67	0.59
28:6:172:SER:HA	28:6:201:LEU:HD12	1.84	0.59
22:0:54:ALA:N	22:0:90:LEU:HD23	2.17	0.59
1:A:1223:ASP:OD2	1:A:1224:ARG:NH1	2.35	0.59
28:6:288:GLY:HA2	28:6:300:GLU:HB3	1.83	0.59
29:7:198:ARG:NH2	29:7:200:ARG:O	2.36	0.59
1:A:351:ARG:HA	1:A:355:MET:HB2	1.84	0.59
2:B:85:LEU:H	2:B:132:VAL:HG12	1.68	0.59
19:S:92:ARG:CB	19:S:95:ASP:HB2	2.32	0.59
31:9:210:SER:HB3	31:9:240:GLU:HB3	1.85	0.59
22:0:106:GLY:CA	22:0:204:VAL:O	2.40	0.59
28:6:61:LEU:HB3	28:6:104:ILE:HG22	1.85	0.59
29:7:295:TYR:HA	29:7:333:ALA:HB2	1.85	0.59
30:8:41:LYS:HB2	30:8:89:LEU:HD12	1.84	0.59
22:0:142:VAL:CG1	22:0:152:LEU:HD11	2.26	0.59
17:Q:169:PRO:HG3	17:Q:177:LEU:HD22	1.85	0.58
17:Q:368:ARG:H	17:Q:369:PRO:HD2	1.68	0.58
18:R:85:MET:HG2	18:R:97:LEU:HD21	1.85	0.58
19:S:92:ARG:CB	19:S:95:ASP:H	2.14	0.58
22:0:61:ARG:CZ	22:0:102:LEU:HB3	2.32	0.58
1:A:1430:CYS:HB2	1:A:1435:THR:HA	1.84	0.58
2:B:755:GLN:NE2	10:J:48:MET:SD	2.75	0.58
6:F:44:ARG:H	6:F:45:PRO:HD2	1.67	0.58
25:3:254:GLU:O	30:8:176:ARG:NH1	2.37	0.58
1:A:563:LEU:HD22	1:A:675:VAL:HG13	1.85	0.58
22:0:12:PHE:CE1	22:0:90:LEU:HG	2.38	0.58
25:3:263:LEU:O	25:3:265:MET:N	2.35	0.58
30:8:173:VAL:HG23	30:8:174:VAL:HG23	1.85	0.58
2:B:934:LYS:HA	2:B:944:THR:HG22	1.86	0.58
2:B:939:HIS:NE2	2:B:983:GLU:OE1	2.36	0.58
9:I:39:CYS:SG	9:I:40:ARG:N	2.74	0.58
14:N:323:GLU:HG3	14:N:325:GLY:H	1.66	0.58
22:0:418:ILE:HG22	22:0:420:PRO:HD3	1.84	0.58
1:A:272:ASN:HB2	13:M:68:GLY:HA3	1.85	0.58
1:A:1212:LEU:HD23	1:A:1259:ILE:HD11	1.84	0.58
21:U:257:GLN:NE2	21:U:270:ASN:OD1	2.35	0.58

*Continued on next page...*

*Continued from previous page...*

Atom-1	Atom-2	Interatomic distance (Å)	Clash overlap (Å)
22:0:81:GLU:HA	22:0:84:ILE:HD12	1.85	0.58
25:3:78:VAL:HA	25:3:82:TYR:HB2	1.84	0.58
3:C:240:ARG:NE	3:C:242:GLU:OE2	2.37	0.58
30:8:193:GLY:O	30:8:283:ARG:NH1	2.37	0.58
30:8:57:ARG:HH22	31:9:115:VAL:HG22	1.69	0.58
5:E:5:GLU:OE1	5:E:9:ARG:NH1	2.37	0.58
13:M:137:ARG:NH2	13:M:170:GLN:OE1	2.37	0.58
23:1:527:GLU:OE1	28:6:297:LYS:NZ	2.36	0.58
2:B:840:MET:O	2:B:842:HIS:N	2.36	0.57
2:B:111:ASN:ND2	2:B:175:ASN:O	2.38	0.57
16:P:200:VAL:HB	16:P:213:ILE:HB	1.86	0.57
23:1:16:ARG:HA	23:1:21:ASP:HA	1.86	0.57
24:2:400:ARG:HG3	24:2:401:LEU:HG	1.86	0.57
1:A:62:GLN:HB2	1:A:84:HIS:HB2	1.87	0.57
24:2:244:THR:HG23	26:4:97:LYS:HE3	1.86	0.57
1:A:934:LEU:O	1:A:936:GLU:N	2.38	0.57
26:4:7:GLU:O	26:4:52:ASN:ND2	2.36	0.57
29:7:497:GLN:HE21	29:7:504:LYS:HA	1.69	0.57
5:E:129:GLN:O	5:E:181:ARG:NH2	2.37	0.57
13:M:67:VAL:HA	13:M:71:GLN:HG2	1.86	0.57
3:C:24:GLU:HG2	3:C:228:ARG:HA	1.87	0.57
21:U:231:ASP:H	21:U:235:GLU:HB2	1.69	0.57
22:0:12:PHE:CE2	22:0:50:VAL:HG13	2.40	0.57
23:1:162:GLN:NE2	23:1:191:ASP:O	2.37	0.57
2:B:806:PHE:O	2:B:1050:ARG:NH1	2.38	0.57
9:I:17:CYS:SG	9:I:18:GLN:N	2.76	0.57
13:M:65:SER:O	13:M:66:ARG:O	2.21	0.57
23:1:328:GLN:O	23:1:330:SER:N	2.38	0.57
1:A:1212:LEU:HB2	1:A:1285:LEU:HD13	1.85	0.57
29:7:109:ARG:HG2	29:7:118:LEU:HB3	1.87	0.57
22:0:192:TYR:CD2	22:0:299:ARG:NH1	2.73	0.56
24:2:122:LEU:O	26:4:46:ASN:ND2	2.38	0.56
1:A:906:LEU:HB3	1:A:975:SER:HB3	1.87	0.56
23:1:70:HIS:HE1	23:1:183:GLY:HA3	1.69	0.56
24:2:195:CYS:SG	24:2:196:ILE:N	2.78	0.56
2:B:779:ILE:HA	2:B:1045:PRO:HA	1.87	0.56
13:M:165:TYR:OH	13:M:169:ARG:NH2	2.38	0.56
19:S:91:PHE:CD1	19:S:91:PHE:N	2.73	0.56
22:0:128:LYS:HE3	23:1:277:LEU:CG	2.34	0.56
22:0:149:ASP:OD1	22:0:149:ASP:N	2.38	0.56
22:0:189:TRP:CZ2	22:0:194:LEU:HD13	2.41	0.56

*Continued on next page...*

*Continued from previous page...*

Atom-1	Atom-2	Interatomic distance (Å)	Clash overlap (Å)
22:0:225:LEU:HD13	22:0:228:LYS:HG3	1.87	0.56
23:1:238:GLY:O	23:1:239:SER:C	2.44	0.56
24:2:352:GLN:O	24:2:398:ARG:NH2	2.39	0.56
24:2:408:LEU:HD11	24:2:440:LEU:HB3	1.86	0.56
26:4:92:ASN:H	26:4:93:PRO:CD	2.17	0.56
2:B:1123:GLY:HA3	2:B:1171:MET:H	1.70	0.56
13:M:247:GLY:HA2	16:P:306:VAL:HG11	1.88	0.56
2:B:626:LEU:HB2	2:B:696:CYS:HB3	1.87	0.56
13:M:65:SER:HB2	13:M:72:ASN:C	2.25	0.56
14:N:359:ASN:ND2	15:O:10:THR:OG1	2.39	0.56
23:1:223:ARG:CB	23:1:237:THR:HG21	2.34	0.56
29:7:336:GLY:HA3	29:7:488:LEU:HB2	1.86	0.56
1:A:1169:VAL:HG12	1:A:1216:LEU:HD22	1.87	0.56
22:0:338:GLU:OE1	25:3:75:ARG:NH1	2.38	0.56
22:0:383:LEU:O	22:0:387:GLU:N	2.38	0.56
1:A:628:VAL:HA	1:A:638:GLY:HA3	1.88	0.56
22:0:419:GLU:HB3	22:0:423:ASP:HB3	1.88	0.56
29:7:168:LEU:HD12	29:7:174:ARG:HD3	1.88	0.56
1:A:481:THR:HG21	2:B:931:ILE:HG22	1.87	0.56
13:M:113:ALA:HB1	13:M:156:ASN:HD21	1.71	0.56
30:8:67:GLN:NE2	30:8:78:LEU:O	2.39	0.56
32:X:62:DG:H2''	32:X:63:DC:H5''	1.87	0.56
2:B:296:GLU:OE1	2:B:379:ARG:NH2	2.39	0.55
5:E:105:VAL:HG22	5:E:130:PHE:HB2	1.88	0.55
8:H:7:GLU:HG3	8:H:59:VAL:HG22	1.88	0.55
8:H:88:PHE:HD2	8:H:144:LEU:HB3	1.71	0.55
2:B:777:ASN:O	10:J:47:ARG:NH1	2.39	0.55
19:S:115:LYS:NZ	19:S:117:GLY:O	2.38	0.55
22:0:85:GLU:O	22:0:88:ARG:HB2	2.05	0.55
1:A:329:MET:HA	13:M:86:LYS:CD	2.20	0.55
1:A:344:LYS:NZ	1:A:1433:GLU:O	2.40	0.55
5:E:55:ARG:NH2	5:E:78:GLU:O	2.40	0.55
14:N:348:LYS:NZ	14:N:373:ASP:OD2	2.38	0.55
29:7:446:ILE:O	29:7:472:ARG:NH2	2.39	0.55
1:A:26:LEU:HD21	1:A:31:LEU:HD13	1.88	0.55
1:A:1289:GLU:OE2	9:I:56:ASN:ND2	2.40	0.55
2:B:428:ASP:HB3	20:T:160:GLN:HA	1.88	0.55
22:0:71:ILE:HG21	22:0:207:TYR:OH	2.07	0.55
22:0:91:LEU:HD23	22:0:91:LEU:C	2.27	0.55
24:2:133:THR:O	24:2:135:GLN:N	2.38	0.55
25:3:6:CYS:HB3	25:3:10:LYS:HA	1.87	0.55

*Continued on next page...*

*Continued from previous page...*

Atom-1	Atom-2	Interatomic distance (Å)	Clash overlap (Å)
28:6:12:GLU:OE1	29:7:330:ASN:ND2	2.40	0.55
29:7:337:VAL:HG22	29:7:465:GLY:HA3	1.89	0.55
8:H:6:PHE:HB3	8:H:60:ILE:HB	1.88	0.55
17:Q:154:CYS:SG	17:Q:155:THR:N	2.78	0.55
24:2:309:VAL:HA	24:2:314:ARG:HH12	1.72	0.55
1:A:629:VAL:HG13	1:A:636:ILE:HB	1.89	0.55
2:B:83:ARG:H	2:B:134:LYS:HA	1.71	0.55
11:K:110:LYS:O	11:K:113:GLN:NE2	2.39	0.55
19:S:94:GLU:O	19:S:114:LYS:NZ	2.39	0.55
21:U:193:SER:O	21:U:197:ASN:ND2	2.40	0.55
1:A:463:THR:HG23	1:A:468:SER:HB2	1.89	0.55
2:B:24:GLU:OE1	2:B:762:ARG:NH1	2.40	0.55
2:B:555:GLU:OE2	20:T:113:ARG:NH2	2.38	0.55
22:0:183:LEU:HB3	22:0:188:GLY:CA	2.37	0.55
23:1:58:GLU:OE2	23:1:89:ARG:NH2	2.39	0.55
25:3:243:GLU:O	25:3:245:LEU:N	2.38	0.55
29:7:619:GLU:HB3	29:7:645:ARG:HD3	1.89	0.55
1:A:77:ASN:HD21	13:M:43:ASP:HB3	1.72	0.55
1:A:641:CYS:SG	1:A:642:LYS:N	2.80	0.55
22:0:497:ARG:NH2	22:0:500:ASP:OD2	2.39	0.55
24:2:338:PHE:HB3	29:7:80:PRO:HD2	1.89	0.55
30:8:143:LEU:HD22	30:8:151:LEU:HD21	1.87	0.55
7:G:106:CYS:SG	7:G:107:PHE:N	2.79	0.55
22:0:82:LYS:HZ1	22:0:669:ARG:HE	1.55	0.55
22:0:231:VAL:HB	22:0:454:VAL:HG22	1.89	0.55
22:0:462:SER:H	22:0:463:PRO:HD2	1.72	0.55
23:1:81:ASN:ND2	23:1:88:GLU:OE1	2.40	0.55
2:B:505:LEU:HG	2:B:509:VAL:HB	1.88	0.55
22:0:437:CYS:SG	22:0:438:MET:N	2.79	0.55
24:2:51:LEU:HB2	26:4:237:GLN:HE22	1.72	0.55
25:3:131:ASP:O	25:3:133:ILE:N	2.40	0.55
1:A:487:SER:HB3	1:A:673:GLN:HE22	1.72	0.54
7:G:36:GLY:O	7:G:155:ASN:ND2	2.39	0.54
12:L:18:ILE:N	12:L:45:TYR:O	2.40	0.54
23:1:223:ARG:CG	23:1:237:THR:HG21	2.36	0.54
23:1:473:ARG:NH2	28:6:294:CYS:SG	2.79	0.54
29:7:166:VAL:HG22	29:7:295:TYR:HB2	1.89	0.54
1:A:122:ASN:HD21	1:A:162:ASN:H	1.55	0.54
1:A:614:ASP:O	1:A:616:GLY:N	2.39	0.54
1:A:821:GLY:HA2	1:A:838:PHE:HB3	1.90	0.54
1:A:1163:HIS:NE2	1:A:1302:GLU:OE1	2.40	0.54

*Continued on next page...*

*Continued from previous page...*

Atom-1	Atom-2	Interatomic distance (Å)	Clash overlap (Å)
2:B:201:ALA:O	2:B:222:ARG:NH2	2.39	0.54
2:B:579:ASP:OD2	2:B:582:GLN:NE2	2.40	0.54
5:E:172:ARG:O	5:E:207:ARG:NH2	2.41	0.54
22:0:85:GLU:OE1	23:1:335:MET:CG	2.56	0.54
23:1:414:TYR:O	23:1:417:LYS:NZ	2.40	0.54
29:7:38:VAL:H	29:7:39:PRO:CD	2.20	0.54
22:0:169:PRO:HG3	22:0:189:TRP:HH2	1.71	0.54
29:7:303:ASN:ND2	29:7:402:GLY:O	2.39	0.54
19:S:102:VAL:HB	19:S:108:ARG:HB3	1.90	0.54
22:0:189:TRP:CE2	22:0:194:LEU:HD13	2.43	0.54
23:1:160:HIS:NE2	23:1:162:GLN:O	2.40	0.54
25:3:272:LEU:HD11	25:3:276:ARG:HH21	1.71	0.54
30:8:51:ALA:HA	31:9:140:LEU:HD22	1.88	0.54
30:8:267:ASP:OD2	30:8:297:ASN:ND2	2.41	0.54
19:S:91:PHE:CA	19:S:96:GLN:NE2	2.68	0.54
29:7:527:THR:O	29:7:530:ARG:NH1	2.41	0.54
30:8:213:LEU:HB3	30:8:221:GLN:HE22	1.73	0.54
1:A:350:VAL:HG21	1:A:1435:THR:HG21	1.90	0.54
23:1:238:GLY:C	23:1:240:LYS:N	2.60	0.54
23:1:367:ASN:ND2	26:4:172:LEU:O	2.36	0.54
24:2:389:ASP:OD1	24:2:392:ARG:NH2	2.40	0.54
26:4:16:ASP:HA	26:4:62:SER:HB2	1.88	0.54
28:6:146:TYR:H	28:6:179:PRO:HG2	1.73	0.54
29:7:500:GLY:HA2	29:7:651:VAL:HG12	1.90	0.54
30:8:26:VAL:HG22	30:8:41:LYS:HG2	1.89	0.54
2:B:188:ASN:OD1	2:B:913:GLN:NE2	2.40	0.54
3:C:7:PRO:O	11:K:104:ARG:NH1	2.41	0.54
8:H:30:CYS:HB2	8:H:39:LEU:HB3	1.89	0.54
14:N:368:SER:HB2	15:O:52:VAL:HG12	1.89	0.54
23:1:83:SER:HA	29:7:603:ASN:HB3	1.90	0.54
28:6:375:VAL:HA	28:6:379:LEU:HB3	1.90	0.54
1:A:603:ILE:HG22	1:A:629:VAL:HA	1.90	0.54
2:B:360:LYS:HG3	2:B:553:LEU:HD23	1.90	0.54
4:D:73:ARG:NH1	4:D:103:LEU:O	2.41	0.54
5:E:147:GLU:HB3	5:E:194:ILE:HB	1.90	0.54
22:0:144:ALA:O	22:0:146:TYR:N	2.41	0.54
24:2:271:VAL:HA	24:2:283:PRO:HA	1.90	0.54
28:6:91:PHE:HB2	28:6:232:LEU:HD13	1.89	0.54
28:6:173:SER:HB3	28:6:201:LEU:H	1.72	0.54
2:B:1062:ARG:NH1	2:B:1081:ASP:O	2.41	0.54
14:N:343:HIS:HB3	14:N:350:LYS:HB2	1.90	0.54

*Continued on next page...*

*Continued from previous page...*

Atom-1	Atom-2	Interatomic distance (Å)	Clash overlap (Å)
1:A:1474:LEU:HB2	6:F:105:ILE:HB	1.89	0.53
2:B:255:ARG:NH2	2:B:307:GLU:OE2	2.41	0.53
2:B:812:ARG:NH1	2:B:900:GLU:OE2	2.41	0.53
6:F:62:ARG:NH1	6:F:126:THR:O	2.41	0.53
14:N:332:GLU:HB3	15:O:92:LYS:HE3	1.89	0.53
14:N:358:MET:HB2	14:N:365:TYR:HB2	1.88	0.53
22:0:386:LEU:O	22:0:387:GLU:HG2	2.07	0.53
31:9:25:ASP:OD1	31:9:28:ARG:NH2	2.41	0.53
1:A:1234:LYS:NZ	1:A:1297:THR:O	2.40	0.53
11:K:108:ALA:O	11:K:112:LYS:NZ	2.41	0.53
18:R:140:LYS:H	18:R:141:PRO:CD	2.20	0.53
22:0:528:SER:O	22:0:564:ASN:ND2	2.41	0.53
30:8:83:HIS:O	30:8:85:SER:N	2.40	0.53
1:A:43:TYR:OH	1:A:285:LYS:NZ	2.40	0.53
2:B:289:ILE:HG13	2:B:291:ASP:H	1.73	0.53
13:M:286:ARG:NH2	32:X:5:DG:OP2	2.41	0.53
22:0:12:PHE:HE2	22:0:50:VAL:HG13	1.73	0.53
30:8:33:ASN:OD1	30:8:34:THR:N	2.38	0.53
1:A:1236:ASN:ND2	1:A:1243:LEU:O	2.40	0.53
11:K:31:CYS:SG	11:K:84:GLN:NE2	2.82	0.53
22:0:70:LEU:HD11	22:0:232:VAL:HB	1.90	0.53
22:0:417:ILE:HB	22:0:434:HIS:HB2	1.89	0.53
25:3:235:LEU:HD11	25:3:268:ARG:HB2	1.91	0.53
28:6:195:ARG:HH11	28:6:216:GLY:HA3	1.72	0.53
13:M:104:ARG:HH22	13:M:112:ARG:HH22	1.56	0.53
22:0:70:LEU:CD1	22:0:232:VAL:HG23	2.37	0.53
30:8:95:GLU:HG2	30:8:96:THR:HG23	1.90	0.53
30:8:109:LEU:HD12	30:8:111:PRO:HD3	1.91	0.53
1:A:516:GLN:O	1:A:523:ARG:NH1	2.42	0.53
2:B:245:GLN:HE21	2:B:252:ILE:HB	1.72	0.53
9:I:84:HIS:CG	9:I:85:PRO:HD3	2.44	0.53
16:P:317:VAL:HG12	16:P:319:ALA:H	1.72	0.53
2:B:63:PRO:HG2	2:B:64:PRO:HD3	1.91	0.53
20:T:122:GLU:OE1	20:T:126:ARG:NH1	2.42	0.53
25:3:216:LYS:HD2	25:3:218:VAL:H	1.73	0.53
28:6:59:ARG:NH1	28:6:236:VAL:O	2.41	0.53
30:8:67:GLN:HG3	30:8:77:LEU:HD23	1.91	0.53
13:M:65:SER:CB	13:M:73:PRO:HA	2.38	0.53
22:0:53:LEU:C	22:0:90:LEU:HD23	2.29	0.53
21:U:230:SER:CB	21:U:235:GLU:OE1	2.56	0.53
22:0:113:LYS:C	22:0:114:ASN:CG	2.64	0.53

*Continued on next page...*



*Continued from previous page...*

Atom-1	Atom-2	Interatomic distance (Å)	Clash overlap (Å)
23:1:55:ILE:HG12	23:1:93:LYS:HD3	1.90	0.53
29:7:289:TYR:H	29:7:290:PRO:CD	2.20	0.53
1:A:1167:ARG:HA	1:A:1293:LEU:HD22	1.90	0.53
13:M:65:SER:O	13:M:66:ARG:C	2.48	0.53
22:0:564:ASN:OD1	22:0:592:ARG:NH1	2.42	0.53
22:0:570:GLU:OE1	22:0:598:SER:OG	2.26	0.53
28:6:54:ARG:O	28:6:322:TYR:OH	2.24	0.53
2:B:915:GLY:O	13:M:133:ASN:ND2	2.42	0.52
22:0:108:ALA:HA	22:0:206:VAL:O	2.09	0.52
22:0:343:ARG:HE	22:0:433:LEU:HD22	1.74	0.52
26:4:92:ASN:H	26:4:93:PRO:HD3	1.75	0.52
28:6:348:CYS:O	28:6:350:GLY:N	2.42	0.52
1:A:122:ASN:ND2	1:A:162:ASN:O	2.42	0.52
1:A:871:VAL:HA	1:A:881:ASN:HA	1.90	0.52
1:A:1354:PRO:HG3	5:E:137:ILE:HD11	1.91	0.52
8:H:100:GLU:HB2	8:H:113:SER:HB2	1.90	0.52
13:M:227:GLN:HE21	13:M:304:PHE:HD1	1.58	0.52
26:4:130:GLU:HB2	26:4:170:SER:HB3	1.89	0.52
1:A:1206:ARG:NH2	1:A:1269:MET:SD	2.81	0.52
1:A:395:THR:OG1	1:A:398:ASN:OD1	2.28	0.52
1:A:918:LYS:O	1:A:1052:ARG:NH1	2.43	0.52
13:M:108:SER:HB2	13:M:111:ASP:HB2	1.90	0.52
17:Q:112:ARG:NH2	18:R:240:GLN:OE1	2.42	0.52
22:0:53:LEU:HD22	22:0:87:LEU:CD1	2.24	0.52
22:0:146:TYR:O	22:0:147:GLN:CG	2.56	0.52
19:S:70:GLU:HG2	19:S:76:ARG:HA	1.92	0.52
25:3:68:VAL:HG12	25:3:70:LYS:H	1.73	0.52
25:3:230:GLY:HA3	25:3:263:LEU:HD13	1.91	0.52
26:4:282:CYS:SG	26:4:283:THR:N	2.83	0.52
3:C:37:VAL:HG13	3:C:41:GLU:HG2	1.92	0.52
5:E:71:GLN:NE2	5:E:97:GLU:O	2.43	0.52
13:M:178:LYS:HG2	20:T:156:VAL:HG12	1.91	0.52
29:7:111:THR:O	29:7:117:LYS:NZ	2.43	0.52
1:A:662:HIS:NE2	6:F:127:ASP:OD1	2.40	0.52
2:B:573:TRP:HZ2	2:B:576:ILE:HG23	1.74	0.52
22:0:132:GLY:HA3	22:0:391:LEU:HD23	1.92	0.52
1:A:609:HIS:H	1:A:610:PRO:HD2	1.75	0.52
17:Q:122:THR:HG22	17:Q:169:PRO:HB2	1.92	0.52
22:0:387:GLU:HG3	22:0:387:GLU:O	2.09	0.52
23:1:65:LEU:HB3	23:1:77:PHE:HB2	1.92	0.52
25:3:171:LEU:HD23	25:3:212:LEU:HD22	1.92	0.52

*Continued on next page...*

*Continued from previous page...*

Atom-1	Atom-2	Interatomic distance (Å)	Clash overlap (Å)
28:6:77:LYS:HD3	28:6:83:CYS:HB2	1.90	0.52
1:A:982:ASN:HD22	1:A:985:ARG:HE	1.57	0.52
17:Q:100:VAL:HB	17:Q:208:PRO:HB3	1.91	0.52
22:0:61:ARG:HH22	22:0:101:LYS:HD2	1.75	0.52
23:1:440:LEU:HD11	24:2:77:LYS:HD3	1.91	0.52
2:B:1000:THR:HG22	2:B:1002:PHE:H	1.75	0.52
15:O:60:GLY:HA3	15:O:79:VAL:HG22	1.91	0.52
1:A:362:SER:OG	1:A:502:ASN:OD1	2.28	0.51
22:0:77:VAL:CG1	23:1:268:ASP:CG	2.78	0.51
23:1:198:ARG:O	23:1:320:ARG:NH2	2.43	0.51
26:4:88:PRO:HG2	26:4:89:PRO:HD3	1.90	0.51
1:A:1000:LEU:HD12	1:A:1001:PRO:HD2	1.91	0.51
1:A:1050:CYS:SG	1:A:1051:SER:N	2.84	0.51
1:A:1171:ALA:HB2	1:A:1217:ASP:HB2	1.92	0.51
7:G:63:ARG:NH1	7:G:65:PHE:O	2.40	0.51
29:7:181:HIS:CG	29:7:182:PRO:HD3	2.44	0.51
1:A:957:GLU:OE2	1:A:960:ARG:NH2	2.41	0.51
15:O:20:ASP:O	15:O:24:GLN:NE2	2.44	0.51
23:1:355:GLN:NE2	26:4:271:CYS:SG	2.80	0.51
29:7:561:PHE:HB2	29:7:623:LEU:HD11	1.92	0.51
1:A:913:ASN:ND2	1:A:1325:ASP:O	2.43	0.51
22:0:497:ARG:HE	22:0:501:GLN:HB3	1.75	0.51
22:0:725:ALA:HB3	28:6:223:LEU:HD21	1.91	0.51
30:8:307:LEU:HD12	30:8:308:PRO:HD2	1.92	0.51
2:B:841:ARG:HG3	2:B:842:HIS:H	1.75	0.51
2:B:934:LYS:HB3	2:B:1053:HIS:HB2	1.93	0.51
10:J:3:ILE:HG23	10:J:15:GLY:HA2	1.93	0.51
16:P:293:TYR:HB3	16:P:302:LEU:HB2	1.92	0.51
22:0:75:ARG:O	22:0:75:ARG:HG2	2.10	0.51
22:0:77:VAL:CB	23:1:268:ASP:CG	2.78	0.51
24:2:143:ARG:HD3	24:2:148:LEU:HD11	1.91	0.51
21:U:230:SER:HB2	21:U:235:GLU:OE1	2.11	0.51
6:F:61:GLU:OE2	6:F:108:ARG:NE	2.44	0.51
13:M:89:GLY:O	13:M:90:ALA:C	2.48	0.51
13:M:94:ASP:HB2	13:M:98:ASN:CA	2.38	0.51
13:M:313:LEU:HD12	13:M:314:PRO:HD2	1.92	0.51
17:Q:385:ASP:OD1	17:Q:385:ASP:N	2.44	0.51
20:T:139:VAL:O	20:T:141:LEU:N	2.42	0.51
31:9:236:LEU:HD23	31:9:237:MET:HG2	1.93	0.51
13:M:106:THR:HA	13:M:112:ARG:HH11	1.75	0.51
15:O:83:GLU:OE1	15:O:86:GLU:N	2.43	0.51

*Continued on next page...*

*Continued from previous page...*

Atom-1	Atom-2	Interatomic distance (Å)	Clash overlap (Å)
22:0:137:LEU:CD1	22:0:153:PRO:HG2	2.41	0.51
22:0:142:VAL:CG1	22:0:152:LEU:HG	2.41	0.51
26:4:175:MET:O	28:6:320:ARG:NH2	2.43	0.51
1:A:660:MET:HB3	1:A:664:ILE:HB	1.93	0.51
22:0:59:TYR:HE2	22:0:68:THR:HG22	1.56	0.51
22:0:71:ILE:HG23	22:0:207:TYR:CE1	2.46	0.51
22:0:244:ILE:HG23	22:0:437:CYS:H	1.76	0.51
23:1:386:PRO:HG2	23:1:389:ILE:HD13	1.92	0.51
1:A:831:LEU:HB2	2:B:715:ASP:HB2	1.92	0.51
23:1:321:LYS:NZ	28:6:180:SER:O	2.44	0.51
31:9:78:SER:O	31:9:162:ASN:ND2	2.44	0.51
2:B:1028:LEU:HD13	2:B:1041:ILE:HB	1.92	0.50
17:Q:207:GLU:O	17:Q:209:THR:N	2.42	0.50
21:U:157:ASP:OD2	21:U:207:ARG:NH2	2.44	0.50
26:4:182:PHE:HZ	28:6:317:HIS:HA	1.76	0.50
28:6:19:TRP:NE1	29:7:98:ASP:OD1	2.38	0.50
29:7:165:LYS:H	29:7:294:GLU:HA	1.76	0.50
29:7:324:LEU:HD21	29:7:356:THR:HG21	1.92	0.50
1:A:686:THR:HG21	2:B:1041:ILE:HG13	1.92	0.50
6:F:73:ILE:HD13	6:F:77:ALA:HB3	1.93	0.50
11:K:29:ASN:HD22	11:K:79:PRO:HA	1.76	0.50
14:N:344:ARG:NH2	33:Y:78:DT:OP1	2.43	0.50
17:Q:258:MET:HB3	23:1:105:ARG:HB3	1.93	0.50
25:3:178:LYS:HG2	25:3:201:HIS:HE1	1.75	0.50
1:A:539:GLN:HE22	2:B:791:GLU:H	1.59	0.50
2:B:905:ASP:OD2	2:B:922:ARG:NH2	2.43	0.50
7:G:166:ASP:OD2	25:3:54:ARG:NH1	2.44	0.50
22:0:76:THR:HB	22:0:78:PRO:HD2	1.93	0.50
23:1:462:LYS:NZ	28:6:274:ALA:O	2.44	0.50
1:A:1024:ASN:OD1	6:F:50:LYS:NZ	2.43	0.50
2:B:31:SER:HG	2:B:766:TYR:HH	1.55	0.50
16:P:171:THR:HG23	16:P:256:GLN:HG3	1.94	0.50
17:Q:249:LEU:HD12	17:Q:250:TYR:HD1	1.76	0.50
22:0:142:VAL:HG22	22:0:152:LEU:CB	2.41	0.50
23:1:531:THR:HG21	28:6:294:CYS:HA	1.93	0.50
24:2:7:ARG:HB2	24:2:199:ALA:HB2	1.92	0.50
24:2:368:LEU:HA	24:2:371:ARG:HH21	1.75	0.50
1:A:514:GLU:HA	6:F:63:ALA:HB1	1.93	0.50
7:G:99:THR:HG21	7:G:143:ILE:HD11	1.92	0.50
22:0:53:LEU:CB	22:0:90:LEU:CD2	2.83	0.50
22:0:609:ASP:OD1	22:0:666:ARG:NH1	2.45	0.50

*Continued on next page...*

*Continued from previous page...*

Atom-1	Atom-2	Interatomic distance (Å)	Clash overlap (Å)
24:2:442:VAL:HG11	27:5:9:LEU:HD22	1.93	0.50
1:A:902:GLU:OE1	1:A:985:ARG:NH2	2.39	0.50
1:A:910:LYS:O	1:A:963:ARG:NH2	2.44	0.50
5:E:172:ARG:HD2	5:E:210:GLN:HB2	1.93	0.50
23:1:417:LYS:HE2	24:2:123:LEU:HB3	1.94	0.50
26:4:139:LYS:NZ	28:6:346:TYR:O	2.44	0.50
1:A:1212:LEU:HD22	1:A:1285:LEU:HB3	1.94	0.50
12:L:18:ILE:HB	12:L:45:TYR:HB3	1.93	0.50
17:Q:110:MET:HG2	18:R:219:LEU:HG	1.94	0.50
17:Q:387:PHE:HB3	23:1:54:LYS:HD3	1.92	0.50
22:0:107:LEU:HB2	22:0:205:VAL:HG22	1.93	0.50
1:A:355:MET:SD	2:B:1091:ARG:NH2	2.85	0.50
17:Q:139:LEU:HD12	17:Q:140:GLU:HG3	1.94	0.50
1:A:201:GLU:HG3	1:A:213:LYS:HG2	1.94	0.50
2:B:1028:LEU:HB2	2:B:1041:ILE:HD13	1.93	0.50
4:D:73:ARG:HH11	4:D:104:CYS:HB2	1.77	0.50
23:1:223:ARG:CD	23:1:237:THR:HG22	2.26	0.50
23:1:393:GLN:NE2	26:4:124:ILE:O	2.44	0.50
29:7:60:ASP:O	29:7:64:GLN:NE2	2.45	0.50
30:8:138:LEU:HD13	30:8:198:ALA:HB3	1.94	0.50
1:A:93:PRO:HB3	1:A:251:THR:HG22	1.94	0.49
1:A:330:GLN:O	13:M:86:LYS:HB2	2.12	0.49
7:G:148:VAL:HB	7:G:160:ILE:HG23	1.94	0.49
16:P:180:LEU:HD11	16:P:215:SER:HA	1.94	0.49
17:Q:149:THR:HG23	17:Q:151:THR:H	1.77	0.49
25:3:170:GLN:NE2	25:3:226:GLY:O	2.44	0.49
1:A:84:HIS:HE1	2:B:1128:ALA:HA	1.76	0.49
1:A:876:ASP:O	1:A:878:THR:N	2.39	0.49
1:A:1323:THR:HG23	1:A:1325:ASP:H	1.77	0.49
2:B:819:SER:HB2	13:M:62:LYS:HE3	1.94	0.49
8:H:111:ARG:NH2	8:H:126:GLN:O	2.45	0.49
10:J:17:LYS:HD2	10:J:38:LEU:HD22	1.93	0.49
16:P:212:LEU:HB2	16:P:220:VAL:HB	1.94	0.49
17:Q:386:GLU:HG3	23:1:60:LYS:HE2	1.93	0.49
22:0:61:ARG:NH2	22:0:102:LEU:H	2.11	0.49
22:0:533:ASP:O	22:0:565:LYS:NZ	2.44	0.49
28:6:273:MET:SD	28:6:275:HIS:N	2.85	0.49
29:7:410:TYR:OH	29:7:441:ASP:O	2.29	0.49
31:9:211:GLN:OE1	31:9:241:ASN:ND2	2.45	0.49
2:B:613:ARG:HD3	2:B:615:TYR:HE2	1.76	0.49
3:C:71:ILE:HG12	3:C:148:ILE:HG21	1.94	0.49

*Continued on next page...*

*Continued from previous page...*

Atom-1	Atom-2	Interatomic distance (Å)	Clash overlap (Å)
22:0:280:ARG:NH1	22:0:385:THR:O	2.41	0.49
23:1:512:ILE:O	23:1:515:GLN:NE2	2.45	0.49
24:2:15:GLN:HE22	24:2:294:VAL:HG12	1.77	0.49
28:6:145:LEU:HD11	28:6:169:ILE:HD13	1.94	0.49
3:C:99:VAL:HB	3:C:165:ALA:HB3	1.94	0.49
7:G:154:LYS:HG3	7:G:155:ASN:H	1.77	0.49
15:O:62:LEU:HA	15:O:76:LEU:HG	1.94	0.49
22:0:146:TYR:O	22:0:147:GLN:NE2	2.46	0.49
30:8:102:ILE:HD11	30:8:206:LEU:HD13	1.94	0.49
1:A:538:VAL:HA	1:A:542:LEU:HB2	1.93	0.49
1:A:542:LEU:HG	1:A:772:SER:HB2	1.94	0.49
1:A:853:LYS:NZ	1:A:1101:GLN:O	2.40	0.49
2:B:262:TYR:CD1	2:B:262:TYR:C	2.86	0.49
30:8:34:THR:HG22	30:8:36:GLN:H	1.77	0.49
1:A:1365:ILE:O	1:A:1370:GLY:N	2.44	0.49
24:2:240:LEU:HD13	26:4:97:LYS:HG2	1.95	0.49
24:2:356:ALA:HB2	24:2:398:ARG:HH21	1.77	0.49
1:A:505:LEU:HD12	1:A:506:PRO:HD2	1.95	0.49
13:M:51:GLU:OE1	13:M:54:THR:OG1	2.25	0.49
18:R:142:LYS:HE2	18:R:144:ASN:HB3	1.95	0.49
24:2:375:VAL:HB	24:2:383:LEU:HD12	1.95	0.49
25:3:187:LEU:HD22	29:7:188:LEU:HB3	1.94	0.49
29:7:165:LYS:HE2	29:7:175:TYR:HE1	1.78	0.49
20:T:66:HIS:ND1	20:T:69:GLY:O	2.46	0.49
22:0:386:LEU:C	22:0:387:GLU:HG2	2.33	0.49
24:2:373:HIS:CD2	24:2:377:LEU:HB2	2.48	0.49
30:8:49:SER:HB2	30:8:52:LYS:HB2	1.95	0.49
3:C:193:ARG:NH2	3:C:218:ALA:O	2.46	0.49
4:D:105:PRO:O	4:D:135:GLN:NE2	2.45	0.49
22:0:113:LYS:CD	23:1:271:ALA:HB3	2.31	0.49
29:7:198:ARG:HA	29:7:271:GLU:HB2	1.95	0.49
2:B:796:MET:HG2	2:B:965:ILE:HG12	1.95	0.48
3:C:205:LYS:NZ	3:C:213:GLU:OE2	2.46	0.48
22:0:61:ARG:NH2	22:0:101:LYS:HD2	2.28	0.48
22:0:82:LYS:NZ	22:0:669:ARG:HE	2.11	0.48
23:1:486:LEU:HG	23:1:488:GLU:H	1.78	0.48
25:3:77:LYS:HD3	25:3:109:LEU:HD23	1.95	0.48
30:8:232:PRO:HB3	30:8:237:TRP:HB3	1.94	0.48
2:B:916:TYR:OH	13:M:62:LYS:NZ	2.46	0.48
9:I:103:ARG:HG3	9:I:105:GLU:H	1.78	0.48
16:P:168:ILE:HB	16:P:224:ALA:HB3	1.95	0.48

*Continued on next page...*

*Continued from previous page...*

Atom-1	Atom-2	Interatomic distance (Å)	Clash overlap (Å)
17:Q:253:ASN:H	23:1:182:ASN:HB2	1.78	0.48
22:0:31:THR:HG21	22:0:455:ILE:HD11	1.95	0.48
28:6:52:GLN:NE2	28:6:234:HIS:O	2.46	0.48
28:6:261:SER:HA	28:6:268:LYS:HG3	1.95	0.48
2:B:1030:ASN:ND2	2:B:1033:THR:OG1	2.46	0.48
10:J:5:VAL:HG12	10:J:6:ARG:HG3	1.95	0.48
13:M:23:LEU:HD21	13:M:32:MET:HB3	1.94	0.48
22:0:535:ILE:HA	22:0:617:ALA:HB3	1.94	0.48
24:2:242:PHE:O	26:4:96:SER:OG	2.29	0.48
29:7:341:PRO:HG3	29:7:496:LEU:HD13	1.94	0.48
1:A:686:THR:HG22	2:B:783:ALA:HA	1.94	0.48
1:A:935:GLN:HG3	1:A:936:GLU:H	1.78	0.48
8:H:31:GLU:HA	8:H:38:ASP:HA	1.95	0.48
17:Q:24:GLY:O	18:R:217:GLN:NE2	2.47	0.48
19:S:80:ARG:O	19:S:81:ARG:CB	2.61	0.48
22:0:143:ARG:NH1	22:0:146:TYR:HE1	2.11	0.48
24:2:177:GLN:HE22	24:2:181:GLN:HE21	1.61	0.48
26:4:160:ARG:HD3	26:4:233:PRO:HA	1.96	0.48
29:7:550:PHE:O	29:7:554:ARG:NH1	2.46	0.48
29:7:580:ILE:HD11	29:7:607:ILE:HG22	1.94	0.48
31:9:35:VAL:HG13	31:9:42:PRO:HG3	1.95	0.48
1:A:598:GLY:O	1:A:992:LYS:NZ	2.42	0.48
2:B:841:ARG:HH21	13:M:49:GLY:HA2	1.78	0.48
22:0:84:ILE:HD13	22:0:176:ASN:HA	1.95	0.48
24:2:35:TYR:O	24:2:117:ASN:ND2	2.46	0.48
2:B:938:ARG:HD3	2:B:1047:TYR:HD2	1.77	0.48
2:B:985:LEU:HB2	2:B:1042:PHE:HZ	1.78	0.48
17:Q:214:LEU:O	17:Q:216:GLN:N	2.47	0.48
19:S:92:ARG:HB2	19:S:95:ASP:HB2	1.95	0.48
22:0:237:HIS:NE2	22:0:662:GLN:OE1	2.46	0.48
25:3:108:ASN:HB3	25:3:113:VAL:HG21	1.96	0.48
25:3:175:LEU:HD13	25:3:208:LEU:HD23	1.94	0.48
29:7:586:GLN:OE1	29:7:589:ARG:NH2	2.46	0.48
30:8:52:LYS:HG3	30:8:54:GLY:H	1.78	0.48
1:A:496:PHE:HD2	2:B:791:GLU:HB3	1.78	0.48
5:E:52:ARG:NH2	5:E:57:ASP:OD2	2.39	0.48
19:S:91:PHE:C	19:S:92:ARG:O	2.51	0.48
22:0:109:LEU:HG	22:0:205:VAL:HG13	1.95	0.48
25:3:49:CYS:SG	25:3:50:GLY:N	2.87	0.48
30:8:115:LYS:NZ	30:8:294:TYR:O	2.46	0.48
14:N:308:GLN:NE2	14:N:313:PRO:O	2.46	0.48

*Continued on next page...*

*Continued from previous page...*

Atom-1	Atom-2	Interatomic distance (Å)	Clash overlap (Å)
20:T:8:ASP:HB3	20:T:105:SER:HA	1.95	0.48
22:0:309:VAL:HG11	22:0:373:ARG:HH21	1.78	0.48
31:9:64:LEU:HD11	31:9:109:ALA:HB2	1.95	0.48
1:A:1310:HIS:HB3	21:U:252:LYS:HD2	1.95	0.48
2:B:57:ARG:NH1	2:B:60:GLU:OE1	2.47	0.48
2:B:684:GLU:HG2	2:B:686:GLU:H	1.79	0.48
8:H:30:CYS:N	8:H:39:LEU:O	2.46	0.48
22:0:93:PHE:HA	22:0:96:LYS:HE2	1.95	0.48
22:0:128:LYS:HE3	23:1:277:LEU:HD11	1.96	0.48
22:0:627:TYR:CZ	22:0:629:GLN:HB3	2.48	0.48
28:6:160:PRO:HG2	28:6:162:HIS:CE1	2.49	0.48
29:7:304:PRO:HG3	29:7:388:GLN:HG3	1.95	0.48
1:A:253:LEU:HD12	1:A:254:PRO:HD2	1.95	0.48
2:B:63:PRO:HB3	2:B:408:PHE:HZ	1.79	0.48
19:S:47:LEU:HD23	20:T:104:LEU:HD13	1.95	0.48
21:U:223:MET:HG3	21:U:224:THR:HG23	1.95	0.48
22:0:536:VAL:HG22	22:0:596:LEU:HD12	1.96	0.48
1:A:859:TYR:OH	1:A:863:ARG:NH2	2.44	0.47
2:B:1022:LEU:HD12	2:B:1023:ARG:HG2	1.94	0.47
5:E:75:PHE:HB3	5:E:90:TYR:HE1	1.79	0.47
12:L:38:GLU:HG2	12:L:39:CYS:H	1.77	0.47
13:M:264:ALA:HA	13:M:308:THR:HB	1.95	0.47
16:P:312:LEU:HD22	16:P:321:ILE:HG23	1.96	0.47
1:A:578:ALA:HA	8:H:93:TYR:HB3	1.97	0.47
2:B:848:LEU:HD11	2:B:865:VAL:HB	1.96	0.47
22:0:93:PHE:HA	22:0:96:LYS:CE	2.43	0.47
22:0:192:TYR:O	22:0:195:ALA:HB3	2.14	0.47
23:1:230:PHE:O	23:1:232:ARG:HD3	2.14	0.47
23:1:544:LEU:HG	23:1:546:LYS:H	1.78	0.47
30:8:66:LEU:HD23	30:8:77:LEU:HB2	1.96	0.47
1:A:1280:ASP:HB3	1:A:1283:VAL:HG22	1.96	0.47
3:C:100:GLU:OE2	3:C:162:ARG:NH2	2.47	0.47
4:D:133:ASP:OD1	4:D:137:LYS:NZ	2.47	0.47
13:M:169:ARG:HH11	13:M:206:VAL:HB	1.80	0.47
17:Q:392:ASP:HA	23:1:97:GLN:HB2	1.96	0.47
22:0:189:TRP:H	22:0:194:LEU:HD22	1.79	0.47
24:2:308:VAL:HG12	24:2:310:GLU:H	1.79	0.47
28:6:39:PHE:HB3	28:6:43:ARG:HH12	1.78	0.47
28:6:59:ARG:NH2	28:6:166:GLU:OE2	2.35	0.47
1:A:166:VAL:HG23	1:A:168:GLN:H	1.79	0.47
1:A:353:ASN:HD22	2:B:1073:GLN:HE22	1.63	0.47

*Continued on next page...*

*Continued from previous page...*

Atom-1	Atom-2	Interatomic distance (Å)	Clash overlap (Å)
19:S:90:GLU:O	19:S:92:ARG:N	2.48	0.47
19:S:91:PHE:CA	19:S:96:GLN:HE21	2.25	0.47
22:0:72:TYR:O	22:0:206:VAL:HA	2.14	0.47
22:0:598:SER:OG	22:0:599:VAL:N	2.45	0.47
24:2:140:LYS:HE2	26:4:93:PRO:HB3	1.96	0.47
28:6:69:ARG:H	28:6:141:GLY:HA2	1.79	0.47
30:8:58:THR:OG1	30:8:157:GLY:O	2.26	0.47
2:B:191:GLU:OE2	2:B:472:ARG:NH1	2.48	0.47
3:C:97:CYS:SG	3:C:98:SER:N	2.88	0.47
9:I:86:CYS:SG	9:I:87:GLN:N	2.87	0.47
22:0:106:GLY:HA3	22:0:174:ILE:HD12	1.96	0.47
22:0:601:ARG:NH2	22:0:625:TYR:O	2.47	0.47
28:6:290:PHE:HB3	28:6:297:LYS:HG2	1.96	0.47
29:7:115:GLU:CD	29:7:116:TYR:H	2.17	0.47
29:7:274:GLN:O	29:7:276:MET:N	2.38	0.47
33:Y:80:DT:H2'	33:Y:81:DA:C8	2.49	0.47
1:A:114:CYS:O	1:A:116:LYS:N	2.43	0.47
1:A:533:PRO:HG2	1:A:647:THR:H	1.79	0.47
2:B:802:ASP:HA	2:B:807:ARG:HH21	1.79	0.47
2:B:825:GLN:HG2	2:B:873:LEU:HD23	1.96	0.47
2:B:1016:SER:HB2	2:B:1022:LEU:HB3	1.96	0.47
7:G:78:ARG:NH1	7:G:79:PRO:O	2.48	0.47
8:H:96:VAL:HG22	8:H:116:VAL:HG22	1.96	0.47
19:S:73:ARG:O	19:S:73:ARG:HG3	2.14	0.47
22:0:95:GLU:HG3	22:0:101:LYS:CG	2.43	0.47
22:0:95:GLU:CG	22:0:101:LYS:HD3	2.30	0.47
22:0:107:LEU:HB2	22:0:205:VAL:HG13	1.95	0.47
30:8:57:ARG:HB2	31:9:114:LYS:HB2	1.95	0.47
2:B:561:ILE:O	2:B:563:ASP:N	2.48	0.47
13:M:64:PRO:C	13:M:66:ARG:N	2.69	0.47
29:7:52:LYS:HD3	29:7:55:GLU:HB3	1.97	0.47
29:7:404:SER:OG	29:7:433:GLN:O	2.32	0.47
29:7:640:LEU:HD12	29:7:644:LEU:HD13	1.95	0.47
2:B:780:VAL:HG22	2:B:965:ILE:HB	1.97	0.47
2:B:867:ILE:HB	2:B:894:THR:HB	1.96	0.47
23:1:163:ASP:HB2	28:6:112:LYS:HD2	1.96	0.47
26:4:153:ASP:O	26:4:155:GLN:N	2.48	0.47
29:7:528:LYS:NZ	33:Y:35:DG:N3	2.63	0.47
15:O:66:ARG:HD3	16:P:185:LEU:HD12	1.97	0.47
19:S:74:LYS:HD3	19:S:74:LYS:HA	1.82	0.47
21:U:173:GLU:OE2	21:U:187:TYR:OH	2.32	0.47

*Continued on next page...*



*Continued from previous page...*

Atom-1	Atom-2	Interatomic distance (Å)	Clash overlap (Å)
22:0:147:GLN:C	22:0:148:HIS:CD2	2.85	0.47
24:2:212:LEU:HD22	24:2:268:PHE:HB3	1.97	0.47
29:7:105:GLU:OE1	29:7:157:LYS:NZ	2.47	0.47
30:8:257:LEU:HD13	30:8:272:ILE:HG22	1.97	0.47
1:A:1052:ARG:NE	1:A:1056:GLU:OE1	2.48	0.46
2:B:42:GLN:HE22	2:B:483:ARG:HE	1.63	0.46
2:B:427:LYS:HG2	20:T:164:GLU:HB2	1.98	0.46
2:B:834:ARG:HD3	2:B:844:ILE:HG22	1.97	0.46
13:M:64:PRO:C	13:M:66:ARG:H	2.18	0.46
16:P:167:ASN:ND2	33:Y:79:DT:O2	2.44	0.46
26:4:294:PRO:HG2	26:4:295:PRO:HD3	1.97	0.46
1:A:379:GLY:HA2	1:A:477:LEU:HD21	1.97	0.46
2:B:224:CYS:HB2	2:B:230:ARG:HB2	1.97	0.46
2:B:732:ALA:HA	2:B:1051:LEU:HA	1.97	0.46
2:B:810:PHE:HB3	2:B:925:SER:HB3	1.96	0.46
2:B:875:GLU:O	2:B:887:TYR:OH	2.33	0.46
14:N:312:GLU:HB2	14:N:313:PRO:HD3	1.97	0.46
16:P:269:ARG:NH2	16:P:336:ARG:O	2.48	0.46
17:Q:77:ARG:NH1	17:Q:91:TYR:OH	2.48	0.46
29:7:442:GLU:OE1	29:7:444:HIS:NE2	2.47	0.46
1:A:86:GLY:HA3	1:A:255:VAL:HB	1.97	0.46
20:T:191:PHE:HA	20:T:197:TYR:HE2	1.80	0.46
1:A:408:ARG:HD3	1:A:412:GLN:HE21	1.80	0.46
1:A:1434:GLU:O	1:A:1436:VAL:N	2.48	0.46
13:M:66:ARG:O	13:M:66:ARG:HG3	2.16	0.46
14:N:314:LEU:HD21	16:P:250:PHE:HB2	1.98	0.46
16:P:165:LEU:HA	16:P:260:GLY:HA2	1.97	0.46
16:P:297:LYS:HB2	16:P:298:PRO:HD3	1.97	0.46
22:0:77:VAL:HB	23:1:268:ASP:OD1	2.15	0.46
22:0:94:TYR:HA	22:0:97:GLN:HB2	1.96	0.46
29:7:197:CYS:HA	29:7:273:LYS:HB2	1.97	0.46
29:7:535:THR:O	29:7:571:TYR:OH	2.33	0.46
1:A:365:THR:HG22	2:B:1059:ILE:HG22	1.97	0.46
2:B:705:GLY:H	2:B:708:ALA:HB3	1.81	0.46
22:0:53:LEU:HB3	22:0:90:LEU:HD22	1.90	0.46
1:A:551:ARG:HH22	8:H:121:LEU:HG	1.81	0.46
1:A:888:GLN:NE2	1:A:1403:ASP:OD2	2.48	0.46
2:B:114:ARG:NH2	2:B:184:TYR:OH	2.48	0.46
2:B:230:ARG:NH2	2:B:398:PRO:O	2.49	0.46
22:0:63:TYR:N	22:0:64:PRO:HD2	2.30	0.46
25:3:7:PRO:HG2	25:3:30:LEU:HG	1.97	0.46

*Continued on next page...*

*Continued from previous page...*

Atom-1	Atom-2	Interatomic distance (Å)	Clash overlap (Å)
1:A:693:ILE:HG21	2:B:1023:ARG:HH21	1.81	0.46
2:B:802:ASP:HB3	3:C:173:HIS:CE1	2.50	0.46
7:G:165:ASP:HB2	7:G:168:LEU:HD11	1.97	0.46
13:M:173:VAL:O	13:M:175:ARG:NH1	2.49	0.46
17:Q:39:ARG:NH2	18:R:160:GLN:O	2.48	0.46
29:7:347:SER:OG	29:7:377:GLN:NE2	2.48	0.46
31:9:209:PRO:HA	31:9:212:ILE:HD12	1.97	0.46
2:B:1116:VAL:HG21	2:B:1156:LYS:HG3	1.98	0.46
4:D:96:GLU:OE2	4:D:117:SER:OG	2.30	0.46
14:N:335:VAL:HG22	14:N:358:MET:HA	1.98	0.46
26:4:207:CYS:O	26:4:212:GLY:N	2.49	0.46
29:7:153:MET:HA	29:7:156:ILE:HD12	1.97	0.46
29:7:416:THR:O	29:7:418:LYS:N	2.44	0.46
1:A:827:TYR:HH	1:A:839:HIS:HE2	1.58	0.46
1:A:1242:ASP:HA	1:A:1262:MET:HB2	1.98	0.46
2:B:821:LYS:HG3	2:B:871:VAL:HG21	1.97	0.46
20:T:187:LEU:HD22	20:T:191:PHE:HE2	1.81	0.46
22:0:12:PHE:CE2	22:0:14:TYR:HB2	2.50	0.46
22:0:102:LEU:CG	22:0:103:PRO:HD2	2.45	0.46
22:0:490:LEU:HD21	22:0:668:ILE:HG12	1.98	0.46
24:2:188:THR:HG22	24:2:191:GLY:H	1.81	0.46
28:6:74:GLN:HG2	28:6:78:PRO:HA	1.97	0.46
28:6:336:LEU:HD11	28:6:340:ASN:H	1.81	0.46
32:X:28:DG:H1	33:Y:66:DC:H42	1.62	0.46
22:0:427:THR:HG23	22:0:429:ALA:H	1.80	0.46
25:3:168:GLU:HG3	25:3:212:LEU:HD21	1.98	0.46
11:K:46:ILE:HG21	11:K:73:ILE:HD13	1.98	0.45
22:0:88:ARG:O	22:0:91:LEU:HB3	2.16	0.45
22:0:192:TYR:O	22:0:196:ARG:HG2	2.16	0.45
23:1:231:HIS:HE1	23:1:306:ARG:HG2	1.80	0.45
29:7:191:ASP:HB3	29:7:192:PRO:HD3	1.97	0.45
30:8:183:LEU:HD11	30:8:194:VAL:HG13	1.98	0.45
16:P:328:ILE:HD12	16:P:331:ILE:HD12	1.97	0.45
17:Q:249:LEU:HB2	17:Q:250:TYR:H	1.59	0.45
17:Q:291:GLY:O	17:Q:293:GLU:N	2.50	0.45
22:0:12:PHE:CE2	22:0:14:TYR:CB	3.00	0.45
23:1:483:THR:H	23:1:484:PRO:HD2	1.82	0.45
24:2:192:GLU:H	24:2:193:PRO:CD	2.25	0.45
29:7:46:VAL:HG22	29:7:48:GLU:HG3	1.98	0.45
1:A:72:GLN:HG2	1:A:74:CYS:H	1.82	0.45
1:A:603:ILE:O	1:A:605:THR:N	2.49	0.45

*Continued on next page...*

*Continued from previous page...*

Atom-1	Atom-2	Interatomic distance (Å)	Clash overlap (Å)
7:G:104:MET:HG3	7:G:157:ILE:HG13	1.98	0.45
22:0:592:ARG:NE	28:6:175:THR:O	2.49	0.45
23:1:108:ASN:HD22	23:1:109:LYS:H	1.65	0.45
23:1:238:GLY:O	23:1:241:ASP:N	2.48	0.45
1:A:1196:TYR:HD2	1:A:1246:ILE:HD11	1.81	0.45
18:R:165:GLY:HA3	18:R:202:PHE:HE1	1.81	0.45
25:3:234:SER:O	25:3:268:ARG:NH2	2.49	0.45
26:4:148:ASN:HA	26:4:151:VAL:HG12	1.97	0.45
28:6:61:LEU:HD13	28:6:166:GLU:HG3	1.99	0.45
30:8:176:ARG:HD3	30:8:217:SER:HA	1.99	0.45
30:8:203:LEU:HD21	30:8:268:LEU:HD11	1.98	0.45
1:A:1435:THR:OG1	1:A:1436:VAL:N	2.49	0.45
5:E:21:CYS:HB3	5:E:26:TYR:HD2	1.80	0.45
17:Q:292:SER:OG	17:Q:293:GLU:N	2.49	0.45
17:Q:358:THR:OG1	17:Q:359:SER:N	2.47	0.45
19:S:70:GLU:CG	19:S:76:ARG:HA	2.47	0.45
21:U:249:GLN:HA	21:U:252:LYS:HE3	1.98	0.45
22:0:344:LEU:HB3	25:3:63:PHE:HZ	1.81	0.45
23:1:389:ILE:HD11	23:1:392:LEU:HB2	1.98	0.45
29:7:435:TRP:O	29:7:461:HIS:ND1	2.43	0.45
1:A:111:CYS:HB3	1:A:114:CYS:HB3	1.98	0.45
1:A:515:ILE:HG23	1:A:519:ALA:HB3	1.98	0.45
2:B:501:LEU:HD11	2:B:505:LEU:HD22	1.99	0.45
22:0:107:LEU:H	22:0:205:VAL:HA	1.82	0.45
22:0:109:LEU:HG	22:0:205:VAL:CG1	2.47	0.45
24:2:164:VAL:HG22	24:2:330:LEU:HD13	1.99	0.45
28:6:59:ARG:HD2	28:6:238:PRO:HB3	1.98	0.45
29:7:52:LYS:O	29:7:54:ASP:N	2.50	0.45
30:8:53:ASP:HB2	31:9:122:SER:HB3	1.98	0.45
30:8:228:THR:HA	30:8:255:ILE:HD12	1.98	0.45
31:9:140:LEU:HA	31:9:143:ILE:HD12	1.99	0.45
1:A:467:MET:HG3	1:A:524:MET:HB3	1.98	0.45
4:D:103:LEU:HD22	7:G:144:ARG:HH12	1.82	0.45
5:E:131:LEU:HB3	5:E:134:GLU:HG2	1.99	0.45
25:3:235:LEU:HD21	25:3:268:ARG:H	1.82	0.45
28:6:341:GLY:O	28:6:343:ARG:N	2.41	0.45
1:A:111:CYS:HA	1:A:188:GLN:HE22	1.81	0.45
1:A:1178:ASP:HB3	1:A:1260:ARG:HH22	1.81	0.45
2:B:620:ARG:NH1	2:B:666:ASP:OD2	2.50	0.45
19:S:167:ARG:NH2	32:X:42:DA:OP1	2.41	0.45
22:0:95:GLU:HG3	22:0:101:LYS:HB2	1.99	0.45

*Continued on next page...*

*Continued from previous page...*

Atom-1	Atom-2	Interatomic distance (Å)	Clash overlap (Å)
22:0:383:LEU:HD22	22:0:389:THR:HG21	1.98	0.45
5:E:55:ARG:HE	5:E:78:GLU:HA	1.82	0.45
17:Q:202:GLU:O	17:Q:204:LEU:N	2.50	0.45
20:T:23:VAL:HG13	20:T:27:LEU:HD23	1.99	0.45
22:0:12:PHE:CZ	22:0:90:LEU:HG	2.52	0.45
22:0:142:VAL:CG1	22:0:152:LEU:CD1	2.66	0.45
23:1:66:GLN:HE21	23:1:74:THR:HB	1.82	0.45
28:6:222:ILE:HD12	28:6:228:TYR:HA	1.99	0.45
1:A:1119:LEU:HD11	1:A:1385:VAL:HG13	1.99	0.45
2:B:1134:THR:HG22	7:G:154:LYS:HB3	1.99	0.45
19:S:82:LYS:HG3	19:S:82:LYS:O	2.17	0.45
23:1:238:GLY:C	23:1:240:LYS:H	2.20	0.45
24:2:76:LYS:HG3	24:2:77:LYS:HG2	1.98	0.45
25:3:269:LEU:HD12	31:9:123:PRO:HB3	1.99	0.45
29:7:384:ILE:HG23	29:7:388:GLN:HB2	1.99	0.45
1:A:340:LYS:HG3	1:A:1436:VAL:HG21	1.98	0.44
1:A:549:THR:HB	1:A:589:LYS:HE3	1.99	0.44
1:A:766:PHE:HE2	1:A:781:ILE:HG12	1.82	0.44
2:B:413:LYS:HD2	19:S:78:GLU:HG3	1.99	0.44
2:B:1025:ASN:HB3	2:B:1040:GLN:HB3	1.99	0.44
13:M:169:ARG:HA	13:M:174:PRO:HG3	1.97	0.44
22:0:189:TRP:O	22:0:194:LEU:CB	2.63	0.44
32:X:14:DA:H2 <sup>o</sup>	32:X:15:DA:H8	1.82	0.44
1:A:428:ASP:OD1	1:A:429:LEU:N	2.49	0.44
1:A:498:GLY:HA3	2:B:934:LYS:HE2	1.99	0.44
6:F:44:ARG:NH1	6:F:113:GLY:O	2.47	0.44
8:H:28:LEU:HD11	8:H:50:VAL:HG21	1.99	0.44
13:M:108:SER:O	13:M:110:SER:N	2.50	0.44
20:T:47:LYS:HG2	20:T:52:THR:HG23	1.99	0.44
22:0:588:CYS:HA	22:0:593:GLY:HA2	1.99	0.44
24:2:310:GLU:OE1	29:7:114:HIS:N	2.47	0.44
28:6:186:ILE:HG12	28:6:211:LEU:HD13	1.98	0.44
1:A:393:ILE:HG21	6:F:74:ALA:HB1	1.99	0.44
1:A:533:PRO:HD3	1:A:654:HIS:CD2	2.52	0.44
2:B:377:LEU:HD11	9:I:58:ILE:HD11	1.98	0.44
4:D:32:LEU:HD11	7:G:4:HIS:HB2	1.99	0.44
22:0:351:GLN:HB3	22:0:418:ILE:HD12	1.97	0.44
26:4:42:MET:SD	26:4:108:ASN:ND2	2.85	0.44
1:A:407:ARG:HG3	1:A:436:SER:HA	2.00	0.44
2:B:16:GLU:HG3	2:B:18:THR:H	1.82	0.44
2:B:801:VAL:HA	2:B:805:PHE:HB3	1.99	0.44

*Continued on next page...*

*Continued from previous page...*

Atom-1	Atom-2	Interatomic distance (Å)	Clash overlap (Å)
3:C:37:VAL:HG12	3:C:248:ALA:HB1	1.99	0.44
7:G:152:VAL:HA	7:G:157:ILE:HG22	1.99	0.44
11:K:5:PRO:HG2	11:K:8:GLU:HB2	2.00	0.44
22:0:37:HIS:ND1	22:0:454:VAL:O	2.51	0.44
22:0:142:VAL:HG13	22:0:152:LEU:HG	2.00	0.44
22:0:469:LYS:HE2	22:0:640:LEU:HD13	1.99	0.44
29:7:303:ASN:O	29:7:305:ASP:N	2.50	0.44
1:A:526:VAL:HA	1:A:533:PRO:HA	1.99	0.44
2:B:313:GLU:HB3	2:B:316:VAL:HG23	2.00	0.44
21:U:245:ILE:H	21:U:245:ILE:HG13	1.67	0.44
22:0:63:TYR:N	22:0:64:PRO:HD3	2.28	0.44
29:7:115:GLU:H	29:7:115:GLU:HG3	1.57	0.44
30:8:64:LYS:HG3	31:9:156:PHE:HD1	1.82	0.44
2:B:879:GLU:OE2	2:B:887:TYR:OH	2.30	0.44
13:M:104:ARG:HH12	13:M:112:ARG:HH22	1.64	0.44
27:5:9:LEU:HD11	27:5:42:HIS:HD2	1.83	0.44
28:6:195:ARG:HA	28:6:215:THR:HB	1.99	0.44
29:7:577:LYS:HD2	29:7:604:THR:HB	2.00	0.44
30:8:102:ILE:HD12	30:8:209:ARG:HA	1.99	0.44
1:A:413:TYR:OH	1:A:450:MET:O	2.34	0.44
1:A:484:LEU:HD12	1:A:488:VAL:HB	1.99	0.44
1:A:624:GLY:O	1:A:626:THR:N	2.51	0.44
2:B:231:PRO:O	2:B:233:SER:N	2.51	0.44
3:C:15:THR:OG1	3:C:18:ASN:OD1	2.33	0.44
22:0:91:LEU:O	22:0:95:GLU:HB2	2.18	0.44
23:1:118:LEU:HB3	23:1:125:PHE:HD1	1.83	0.44
24:2:48:LEU:HB3	24:2:49:PRO:HD3	2.00	0.44
25:3:129:ASN:OD1	25:3:130:LYS:N	2.49	0.44
28:6:61:LEU:HD11	28:6:168:LEU:HB2	2.00	0.44
29:7:419:ARG:HG3	29:7:422:GLU:HB2	2.00	0.44
14:N:353:LEU:HB2	14:N:370:ALA:HB3	1.98	0.44
28:6:362:VAL:HG11	28:6:389:ILE:HD11	1.99	0.44
2:B:626:LEU:HG	2:B:698:ILE:HD13	1.99	0.44
14:N:318:ASP:HA	16:P:239:ARG:HG2	2.00	0.44
22:0:85:GLU:OE1	23:1:335:MET:HG2	2.17	0.44
1:A:533:PRO:HD3	1:A:654:HIS:HD2	1.83	0.43
1:A:669:TYR:HA	1:A:672:ILE:HG22	2.00	0.43
13:M:89:GLY:O	13:M:90:ALA:O	2.36	0.43
20:T:99:SER:HB2	20:T:103:LYS:HB3	2.00	0.43
24:2:406:GLY:HA2	24:2:445:PRO:HD3	2.00	0.43
29:7:165:LYS:NZ	29:7:278:GLU:OE2	2.38	0.43

*Continued on next page...*

*Continued from previous page...*

Atom-1	Atom-2	Interatomic distance (Å)	Clash overlap (Å)
30:8:298:ARG:HB3	30:8:299:PRO:HD3	2.00	0.43
1:A:827:TYR:OH	1:A:839:HIS:NE2	2.48	0.43
10:J:63:ALA:HB3	10:J:64:PRO:HD3	2.00	0.43
22:0:132:GLY:CA	22:0:391:LEU:HD23	2.48	0.43
25:3:44:GLY:HA3	25:3:53:LEU:HB2	2.00	0.43
2:B:393:LEU:HD11	2:B:621:ILE:HD11	1.99	0.43
8:H:118:TYR:HE2	8:H:143:LEU:HD22	1.83	0.43
21:U:231:ASP:O	21:U:233:LEU:N	2.51	0.43
22:0:143:ARG:HH11	22:0:146:TYR:HE1	1.67	0.43
22:0:590:ASN:HB2	23:1:328:GLN:HE22	1.82	0.43
24:2:316:TYR:HB2	24:2:343:VAL:HG13	2.00	0.43
26:4:269:SER:OG	26:4:270:VAL:N	2.50	0.43
2:B:712:PRO:HG3	2:B:938:ARG:HH21	1.82	0.43
16:P:206:GLU:HB2	16:P:207:PRO:HD3	2.00	0.43
20:T:45:ILE:HG23	20:T:54:VAL:HG22	2.00	0.43
23:1:331:GLU:HG2	23:1:333:SER:H	1.83	0.43
32:X:19:DG:H1	33:Y:75:DC:H42	1.66	0.43
2:B:225:LEU:H	2:B:230:ARG:HA	1.83	0.43
7:G:54:ILE:HG23	7:G:70:VAL:HG22	2.00	0.43
8:H:64:LEU:H	8:H:70:LEU:HD21	1.83	0.43
20:T:55:SER:HA	20:T:82:PRO:HA	2.00	0.43
22:0:12:PHE:HE2	22:0:50:VAL:CG1	2.30	0.43
24:2:37:HIS:NE2	24:2:135:GLN:OE1	2.52	0.43
24:2:186:LYS:HB2	24:2:197:THR:HG22	1.99	0.43
29:7:109:ARG:HE	29:7:118:LEU:HD23	1.83	0.43
1:A:935:GLN:HA	1:A:1001:PRO:HA	1.99	0.43
2:B:566:LYS:HA	2:B:576:ILE:HG22	2.01	0.43
2:B:751:LEU:HD23	2:B:754:PRO:HA	2.00	0.43
13:M:263:GLN:HA	13:M:268:LYS:HG2	1.99	0.43
16:P:169:VAL:HG22	16:P:222:THR:HG22	2.01	0.43
23:1:65:LEU:O	23:1:77:PHE:N	2.50	0.43
23:1:161:LYS:O	23:1:163:ASP:N	2.52	0.43
26:4:149:LYS:O	26:4:152:LYS:NZ	2.39	0.43
29:7:122:SER:O	29:7:124:TYR:N	2.50	0.43
1:A:783:GLN:HG2	1:A:788:VAL:HA	2.00	0.43
2:B:439:ILE:HD12	13:M:81:SER:HA	2.00	0.43
17:Q:377:ARG:HH11	17:Q:381:GLU:HA	1.83	0.43
18:R:131:GLU:HB3	18:R:138:ALA:HB3	1.99	0.43
2:B:873:LEU:HB2	2:B:874:PRO:HD3	2.01	0.43
13:M:94:ASP:OD2	13:M:98:ASN:HA	2.18	0.43
13:M:104:ARG:O	13:M:105:ARG:NH2	2.50	0.43

*Continued on next page...*

*Continued from previous page...*

Atom-1	Atom-2	Interatomic distance (Å)	Clash overlap (Å)
19:S:59:GLU:HG3	19:S:59:GLU:O	2.19	0.43
22:0:517:ILE:HG23	22:0:548:THR:HG23	2.01	0.43
1:A:272:ASN:HD22	13:M:68:GLY:C	2.22	0.43
1:A:458:PHE:HB3	1:A:472:HIS:HD2	1.84	0.43
2:B:215:TYR:HA	2:B:240:LEU:HA	2.00	0.43
2:B:226:GLU:OE2	2:B:227:ASN:ND2	2.52	0.43
3:C:106:ARG:HG3	3:C:158:GLU:HG2	2.00	0.43
3:C:138:ASP:O	3:C:140:ASN:N	2.51	0.43
4:D:72:SER:O	4:D:142:TYR:OH	2.36	0.43
14:N:318:ASP:HB3	16:P:239:ARG:HE	1.84	0.43
19:S:84:TYR:O	19:S:86:ILE:CG1	2.55	0.43
20:T:4:ARG:NH1	20:T:102:ASP:OD2	2.52	0.43
22:0:263:LEU:HD22	22:0:336:LEU:HD13	2.00	0.43
22:0:386:LEU:O	22:0:387:GLU:CG	2.67	0.43
22:0:524:LEU:HD11	22:0:595:ILE:HD11	2.00	0.43
24:2:426:ARG:NH2	24:2:434:GLU:OE1	2.52	0.43
26:4:66:GLU:HA	28:6:387:HIS:CD2	2.54	0.43
28:6:62:TYR:HE2	28:6:156:LEU:HD13	1.84	0.43
1:A:43:TYR:HD2	1:A:45:GLU:HG2	1.84	0.43
2:B:906:GLN:HE22	12:L:45:TYR:HE1	1.67	0.43
22:0:70:LEU:HD11	22:0:232:VAL:CG2	2.49	0.43
22:0:243:CYS:HB2	22:0:440:ALA:HB1	2.01	0.43
22:0:253:ARG:NH2	22:0:429:ALA:O	2.52	0.43
30:8:98:LEU:HD22	30:8:143:LEU:HD12	2.00	0.43
1:A:840:ALA:HA	2:B:719:SER:HB2	2.01	0.42
1:A:1016:LEU:HD23	1:A:1045:LEU:HD21	2.01	0.42
3:C:195:THR:OG1	3:C:196:VAL:N	2.47	0.42
13:M:293:TYR:HB3	13:M:294:PRO:HD3	2.01	0.42
17:Q:40:ASN:HA	17:Q:220:HIS:CE1	2.55	0.42
17:Q:393:ASP:OD2	17:Q:406:SER:OG	2.32	0.42
22:0:53:LEU:C	22:0:90:LEU:CD2	2.87	0.42
22:0:270:VAL:HA	22:0:273:ILE:HD12	2.00	0.42
28:6:389:ILE:HB	28:6:390:PRO:HD3	2.00	0.42
30:8:146:ASP:OD1	30:8:150:VAL:N	2.50	0.42
1:A:1146:GLN:HB3	1:A:1153:ARG:HD3	2.01	0.42
2:B:216:ALA:HB2	2:B:241:ALA:HB2	2.01	0.42
11:K:20:THR:HB	11:K:34:THR:HB	2.00	0.42
16:P:171:THR:HG22	16:P:220:VAL:HG22	2.01	0.42
22:0:135:HIS:CE1	22:0:139:ALA:HB3	2.54	0.42
24:2:100:LEU:HG	24:2:101:LEU:HG	2.01	0.42
28:6:11:TRP:N	29:7:329:GLY:O	2.51	0.42

*Continued on next page...*

*Continued from previous page...*

Atom-1	Atom-2	Interatomic distance (Å)	Clash overlap (Å)
28:6:167:VAL:N	28:6:195:ARG:O	2.50	0.42
1:A:119:VAL:HG21	1:A:123:ASN:HD22	1.83	0.42
1:A:272:ASN:ND2	13:M:68:GLY:CA	2.69	0.42
2:B:133:ILE:O	2:B:134:LYS:HG2	2.19	0.42
2:B:856:PRO:HD3	12:L:46:LYS:HD3	2.00	0.42
22:0:12:PHE:O	22:0:12:PHE:CD2	2.72	0.42
24:2:119:ARG:O	24:2:124:GLY:N	2.53	0.42
1:A:734:ARG:NH2	9:I:104:ALA:O	2.40	0.42
2:B:615:TYR:O	2:B:620:ARG:NH2	2.52	0.42
2:B:748:ALA:HB3	2:B:811:TYR:HB2	2.01	0.42
2:B:838:GLN:OE1	2:B:886:ARG:NH1	2.52	0.42
3:C:91:GLU:O	3:C:93:PHE:N	2.52	0.42
3:C:169:PHE:CE1	3:C:171:LYS:HB3	2.55	0.42
22:0:54:ALA:N	22:0:90:LEU:CD2	2.82	0.42
22:0:341:LYS:HA	25:3:63:PHE:HE2	1.85	0.42
22:0:342:TRP:HE3	22:0:345:ARG:HH22	1.67	0.42
24:2:192:GLU:N	24:2:193:PRO:HD2	2.32	0.42
28:6:12:GLU:HB3	29:7:330:ASN:HB3	2.00	0.42
30:8:225:ILE:HG23	30:8:229:LEU:HD12	2.00	0.42
2:B:847:LYS:HB3	2:B:858:VAL:HG11	2.02	0.42
5:E:87:ILE:HG13	5:E:114:ALA:HB1	2.02	0.42
13:M:65:SER:HB2	13:M:72:ASN:O	2.19	0.42
22:0:427:THR:OG1	22:0:428:ILE:N	2.50	0.42
23:1:83:SER:OG	23:1:84:THR:N	2.52	0.42
28:6:100:PRO:HB2	28:6:302:PRO:HG2	2.02	0.42
30:8:72:PRO:O	30:8:152:LYS:NZ	2.41	0.42
32:X:26:DG:H2'	32:X:27:DG:C8	2.54	0.42
1:A:381:PRO:HB3	1:A:480:SER:HA	2.01	0.42
1:A:883:ILE:HG21	1:A:1424:THR:HA	2.01	0.42
2:B:262:TYR:HE1	2:B:325:GLY:CA	2.32	0.42
17:Q:146:ASP:HB3	17:Q:149:THR:HG22	2.02	0.42
24:2:40:THR:HG21	24:2:118:LEU:HA	2.01	0.42
24:2:274:ARG:HG2	24:2:275:LYS:H	1.84	0.42
1:A:31:LEU:HG	1:A:87:HIS:HB3	2.02	0.42
2:B:94:SER:HB3	20:T:147:LYS:HA	2.01	0.42
2:B:363:TYR:CG	2:B:553:LEU:HD11	2.55	0.42
2:B:416:ARG:NH1	19:S:73:ARG:HD3	2.35	0.42
2:B:1119:CYS:SG	2:B:1120:ASN:N	2.93	0.42
8:H:1:MET:N	8:H:67:ASP:OD2	2.52	0.42
18:R:147:ASP:HB3	18:R:150:ALA:HB2	2.02	0.42
18:R:168:LEU:HD22	18:R:199:LYS:HB2	2.02	0.42

*Continued on next page...*



*Continued from previous page...*

Atom-1	Atom-2	Interatomic distance (Å)	Clash overlap (Å)
31:9:181:LEU:HD21	31:9:226:ILE:HG21	2.01	0.42
1:A:362:SER:HB3	2:B:1084:LEU:HD13	2.01	0.42
2:B:363:TYR:HB2	2:B:553:LEU:HD21	2.02	0.42
2:B:952:GLU:HB3	3:C:36:ARG:HG2	2.02	0.42
2:B:989:VAL:HG22	2:B:1015:LEU:HB2	2.01	0.42
19:S:70:GLU:HB3	19:S:76:ARG:CB	2.49	0.42
19:S:92:ARG:HB3	19:S:93:PRO:CD	2.47	0.42
22:0:220:LEU:HD13	22:0:450:ARG:HG2	2.02	0.42
23:1:165:GLY:HA2	28:6:180:SER:HB3	2.01	0.42
23:1:172:ALA:HB3	28:6:142:GLU:HG3	2.01	0.42
26:4:115:ILE:HG13	26:4:119:MET:HG2	2.02	0.42
30:8:45:LEU:HD13	30:8:55:ILE:HA	2.01	0.42
2:B:427:LYS:HE3	20:T:164:GLU:HG2	2.02	0.42
5:E:173:ILE:HG22	5:E:209:VAL:HA	2.01	0.42
7:G:97:LEU:HD23	7:G:108:ILE:HD12	2.02	0.42
9:I:91:HIS:ND1	9:I:92:LYS:O	2.52	0.42
17:Q:275:LYS:HE3	23:1:11:ILE:HD13	2.01	0.42
19:S:16:VAL:HG22	19:S:135:PHE:HB2	2.02	0.42
22:0:251:LEU:HD21	22:0:256:LEU:HB2	2.02	0.42
22:0:668:ILE:HG22	22:0:673:ASP:HB2	2.02	0.42
23:1:387:THR:OG1	23:1:388:PRO:HD3	2.20	0.42
24:2:339:PRO:O	24:2:341:MET:N	2.47	0.42
24:2:397:GLU:O	24:2:400:ARG:NH1	2.42	0.42
28:6:54:ARG:HB3	28:6:238:PRO:HB2	2.01	0.42
32:X:60:DG:H1	33:Y:34:DC:H42	1.68	0.42
1:A:197:GLU:OE2	1:A:308:LYS:NZ	2.50	0.42
2:B:130:LYS:HB2	2:B:143:GLN:HB2	2.02	0.42
2:B:133:ILE:C	2:B:135:GLU:H	2.23	0.42
2:B:262:TYR:HE1	2:B:325:GLY:HA2	1.85	0.42
22:0:365:VAL:HG12	22:0:367:ILE:HG12	2.02	0.42
23:1:131:LEU:HB3	23:1:137:ILE:HD11	2.00	0.42
23:1:454:PRO:O	23:1:456:ASP:N	2.53	0.42
1:A:874:LYS:HB3	6:F:111:PRO:HG3	2.02	0.41
1:A:1244:ASN:HB3	1:A:1260:ARG:HB2	2.02	0.41
2:B:63:PRO:CG	2:B:64:PRO:HD3	2.50	0.41
2:B:600:GLU:O	2:B:620:ARG:NH2	2.41	0.41
3:C:187:ASP:OD2	3:C:191:ALA:N	2.47	0.41
22:0:50:VAL:O	22:0:90:LEU:HD21	2.20	0.41
22:0:143:ARG:HA	22:0:143:ARG:HD3	1.62	0.41
28:6:255:PRO:HG3	28:6:312:LEU:HD13	2.02	0.41
31:9:71:PHE:HE1	31:9:125:PHE:HA	1.85	0.41

*Continued on next page...*

*Continued from previous page...*

Atom-1	Atom-2	Interatomic distance (Å)	Clash overlap (Å)
1:A:1279:MET:HG2	1:A:1284:PHE:HD1	1.85	0.41
2:B:270:ILE:HA	2:B:273:PHE:HD2	1.84	0.41
2:B:979:GLY:HA2	2:B:982:ILE:HD12	2.02	0.41
19:S:91:PHE:O	19:S:91:PHE:CG	2.73	0.41
22:0:107:LEU:N	22:0:204:VAL:O	2.52	0.41
28:6:75:ASP:HB2	28:6:80:ARG:HH21	1.86	0.41
29:7:127:VAL:HG12	29:7:293:ALA:HB2	2.03	0.41
30:8:178:TYR:OH	30:8:205:GLU:OE1	2.35	0.41
1:A:420:ILE:HB	1:A:445:LYS:HB2	2.01	0.41
2:B:470:LEU:HD11	2:B:478:THR:HG23	2.02	0.41
2:B:1066:PRO:HB3	13:M:47:ASP:HB2	2.02	0.41
2:B:1108:PHE:CZ	2:B:1150:ARG:HB3	2.56	0.41
13:M:93:PHE:HD1	13:M:93:PHE:HA	1.74	0.41
17:Q:359:SER:OG	17:Q:360:GLU:N	2.53	0.41
19:S:62:MET:SD	19:S:84:TYR:CE1	3.14	0.41
22:0:323:ILE:HD13	25:3:100:GLU:HB3	2.02	0.41
28:6:315:ALA:H	28:6:316:PRO:CD	2.33	0.41
1:A:1305:SER:HB2	1:A:1339:ASP:HB3	2.02	0.41
2:B:678:THR:HA	2:B:679:PRO:HD3	1.93	0.41
4:D:91:LYS:O	4:D:121:ARG:NH1	2.53	0.41
14:N:10:VAL:HB	14:N:11:PRO:HD3	2.01	0.41
22:0:77:VAL:HA	22:0:80:ILE:HD12	2.02	0.41
22:0:568:PHE:HA	23:1:307:PHE:HE1	1.84	0.41
28:6:202:SER:OG	28:6:203:ALA:N	2.52	0.41
28:6:222:ILE:HG13	28:6:228:TYR:HD1	1.85	0.41
1:A:632:ASN:HA	1:A:992:LYS:HE3	2.01	0.41
1:A:784:VAL:HG23	1:A:785:ILE:HG13	2.02	0.41
2:B:90:GLN:NE2	20:T:140:ARG:O	2.42	0.41
15:O:72:TRP:HB2	15:O:97:ALA:HB3	2.02	0.41
17:Q:54:PHE:HD2	17:Q:59:LEU:HD13	1.85	0.41
1:A:477:LEU:HD22	1:A:483:ARG:HD3	2.01	0.41
1:A:502:ASN:OD1	1:A:503:LEU:N	2.53	0.41
1:A:1355:VAL:HA	5:E:142:HIS:HA	2.02	0.41
2:B:607:ILE:HG21	9:I:72:VAL:HA	2.03	0.41
17:Q:214:LEU:HD12	17:Q:221:ALA:HB2	2.02	0.41
22:0:285:TYR:OH	22:0:322:SER:O	2.34	0.41
23:1:462:LYS:HD2	28:6:277:ASP:HA	2.03	0.41
24:2:145:VAL:HB	24:2:146:PRO:HD3	2.01	0.41
1:A:718:GLU:O	1:A:722:ASN:ND2	2.54	0.41
1:A:1009:VAL:HG11	1:A:1051:SER:HA	2.01	0.41
17:Q:257:ASN:HD22	23:1:102:LYS:HD2	1.85	0.41

*Continued on next page...*

*Continued from previous page...*

Atom-1	Atom-2	Interatomic distance (Å)	Clash overlap (Å)
22:0:677:MET:SD	22:0:677:MET:N	2.94	0.41
1:A:872:MET:HA	1:A:1087:VAL:HG12	2.01	0.41
2:B:584:MET:HG3	2:B:605:ARG:HD2	2.02	0.41
4:D:38:HIS:CE1	4:D:69:ALA:HB2	2.56	0.41
13:M:173:VAL:HB	13:M:175:ARG:HH12	1.86	0.41
22:0:12:PHE:HA	22:0:13:PRO:HD2	1.90	0.41
22:0:111:SER:HA	22:0:192:TYR:HE1	1.86	0.41
22:0:112:ARG:NH1	22:0:131:ASP:OD2	2.54	0.41
24:2:156:TRP:HZ3	24:2:323:LEU:HD11	1.85	0.41
25:3:191:ASP:O	25:3:192:LEU:HB2	2.21	0.41
25:3:263:LEU:HB3	25:3:264:GLU:H	1.72	0.41
28:6:265:GLN:HG2	28:6:286:LEU:HD22	2.01	0.41
28:6:314:SER:HB2	28:6:318:LEU:HB2	2.02	0.41
1:A:208:ASP:OD2	1:A:212:LYS:NZ	2.45	0.41
1:A:361:PHE:HB3	1:A:505:LEU:HB3	2.02	0.41
1:A:539:GLN:HE22	2:B:791:GLU:N	2.19	0.41
1:A:677:ASN:ND2	2:B:786:THR:O	2.51	0.41
1:A:1083:PRO:HD2	6:F:58:THR:HG21	2.02	0.41
2:B:704:LEU:HD22	2:B:708:ALA:HB1	2.03	0.41
2:B:744:MET:HG2	2:B:922:ARG:HH11	1.86	0.41
5:E:120:ASP:O	5:E:122:ALA:N	2.54	0.41
8:H:106:THR:O	8:H:108:ALA:N	2.54	0.41
13:M:133:ASN:OD1	13:M:134:ILE:N	2.54	0.41
22:0:62:ALA:HB1	22:0:65:LEU:HG	2.03	0.41
22:0:105:LEU:HD21	22:0:198:SER:HB2	2.03	0.41
22:0:128:LYS:HD3	23:1:277:LEU:HD21	1.94	0.41
22:0:341:LYS:O	22:0:345:ARG:NE	2.54	0.41
22:0:406:LEU:HB3	22:0:435:PHE:HE2	1.86	0.41
22:0:501:GLN:O	22:0:502:VAL:HG12	2.21	0.41
23:1:33:TRP:HB3	23:1:43:ILE:HB	2.02	0.41
29:7:603:ASN:OD1	29:7:604:THR:N	2.51	0.41
30:8:65:LEU:HD21	31:9:158:LEU:H	1.86	0.41
30:8:106:SER:HA	30:8:209:ARG:HH21	1.86	0.41
2:B:429:PHE:HE2	2:B:431:LEU:HD12	1.85	0.41
4:D:33:LEU:HD12	4:D:36:GLU:H	1.86	0.41
5:E:73:PHE:HB3	5:E:99:ILE:HD13	2.02	0.41
10:J:1:MET:N	10:J:53:VAL:O	2.54	0.41
12:L:18:ILE:HD11	12:L:47:LYS:HE3	2.03	0.41
22:0:128:LYS:HE3	23:1:277:LEU:CD1	2.51	0.41
26:4:246:PRO:HG2	28:6:263:SER:HA	2.02	0.41
30:8:53:ASP:HA	31:9:110:PHE:HZ	1.86	0.41

*Continued on next page...*

*Continued from previous page...*

Atom-1	Atom-2	Interatomic distance (Å)	Clash overlap (Å)
1:A:629:VAL:HG22	1:A:636:ILE:HD12	2.02	0.40
17:Q:372:VAL:HG21	17:Q:433:MET:HE1	2.03	0.40
19:S:89:LYS:HA	19:S:89:LYS:HD3	1.43	0.40
22:0:113:LYS:CE	23:1:268:ASP:HA	2.48	0.40
22:0:294:GLU:HG3	22:0:296:SER:H	1.86	0.40
22:0:552:TRP:HB3	22:0:558:LEU:H	1.86	0.40
24:2:65:PRO:HB3	24:2:109:ILE:HB	2.03	0.40
26:4:165:LYS:HD3	26:4:195:VAL:HG12	2.03	0.40
29:7:34:PRO:HB2	29:7:35:GLN:H	1.66	0.40
5:E:67:ASP:O	5:E:69:THR:N	2.52	0.40
11:K:33:PHE:HB2	11:K:73:ILE:HB	2.04	0.40
21:U:230:SER:HA	21:U:234:LYS:HB3	2.04	0.40
28:6:276:LEU:HD11	28:6:297:LYS:HE2	2.02	0.40
29:7:359:LYS:HD2	29:7:437:LEU:HB2	2.03	0.40
29:7:474:ASP:HB3	29:7:633:ARG:HE	1.85	0.40
1:A:377:GLN:HE21	1:A:473:ARG:HH21	1.69	0.40
3:C:130:VAL:O	3:C:134:ASN:ND2	2.49	0.40
7:G:49:THR:OG1	7:G:50:THR:N	2.51	0.40
22:0:70:LEU:HD11	22:0:232:VAL:CB	2.51	0.40
22:0:497:ARG:NH1	22:0:709:THR:OG1	2.54	0.40
24:2:369:ARG:HE	24:2:384:PRO:HG3	1.86	0.40
26:4:88:PRO:CG	26:4:89:PRO:HD3	2.50	0.40
29:7:73:SER:OG	29:7:74:ARG:HD3	2.21	0.40
29:7:565:VAL:HG13	29:7:581:TYR:HB2	2.02	0.40
1:A:987:ILE:HG12	1:A:1068:LEU:HD21	2.02	0.40
3:C:239:LEU:HD23	3:C:244:ILE:HG12	2.04	0.40
7:G:83:GLU:HG2	7:G:85:VAL:HG13	2.02	0.40
17:Q:363:ASP:OD1	17:Q:363:ASP:N	2.53	0.40
20:T:230:LYS:HG2	33:Y:67:DC:H4'	2.03	0.40
24:2:155:ARG:HD2	24:2:267:GLU:HA	2.02	0.40
24:2:322:GLU:HA	24:2:325:ILE:HD12	2.03	0.40
28:6:58:MET:SD	28:6:162:HIS:NE2	2.90	0.40
29:7:156:ILE:O	29:7:158:LEU:N	2.49	0.40
30:8:147:GLU:O	30:8:309:ARG:NH1	2.55	0.40
1:A:521:VAL:HG12	1:A:522:PRO:HD3	2.04	0.40
1:A:532:ARG:HE	1:A:649:ALA:HB2	1.86	0.40
2:B:455:ASP:O	2:B:457:LYS:N	2.44	0.40
8:H:88:PHE:HB3	8:H:89:GLU:H	1.75	0.40
11:K:116:ILE:H	11:K:116:ILE:HG13	1.73	0.40
13:M:74:LEU:HD12	13:M:78:GLY:O	2.22	0.40
20:T:94:THR:HG22	20:T:109:ILE:HG13	2.02	0.40

*Continued on next page...*

Continued from previous page...

Atom-1	Atom-2	Interatomic distance (Å)	Clash overlap (Å)
24:2:144:ASP:OD1	24:2:146:PRO:HD2	2.21	0.40
25:3:9:CYS:C	25:3:11:THR:H	2.25	0.40

There are no symmetry-related clashes.

## 5.3 Torsion angles [i](#)

### 5.3.1 Protein backbone [i](#)

In the following table, the Percentiles column shows the percent Ramachandran outliers of the chain as a percentile score with respect to all PDB entries followed by that with respect to all EM entries.

The Analysed column shows the number of residues for which the backbone conformation was analysed, and the total number of residues.

Mol	Chain	Analysed	Favoured	Allowed	Outliers	Percentiles	
1	A	1474/1970 (75%)	1256 (85%)	180 (12%)	38 (3%)	4	26
2	B	1163/1174 (99%)	1003 (86%)	140 (12%)	20 (2%)	7	37
3	C	273/275 (99%)	222 (81%)	40 (15%)	11 (4%)	2	18
4	D	127/142 (89%)	114 (90%)	12 (9%)	1 (1%)	16	55
5	E	208/210 (99%)	184 (88%)	19 (9%)	5 (2%)	5	27
6	F	84/127 (66%)	77 (92%)	6 (7%)	1 (1%)	11	44
7	G	169/172 (98%)	153 (90%)	14 (8%)	2 (1%)	11	44
8	H	148/150 (99%)	107 (72%)	36 (24%)	5 (3%)	3	21
9	I	123/125 (98%)	93 (76%)	27 (22%)	3 (2%)	5	27
10	J	65/67 (97%)	54 (83%)	8 (12%)	3 (5%)	2	17
11	K	115/117 (98%)	106 (92%)	8 (7%)	1 (1%)	14	52
12	L	44/58 (76%)	32 (73%)	11 (25%)	1 (2%)	5	28
13	M	308/316 (98%)	252 (82%)	45 (15%)	11 (4%)	3	20
14	N	109/376 (29%)	96 (88%)	12 (11%)	1 (1%)	14	52
15	O	97/109 (89%)	90 (93%)	7 (7%)	0	100	100
16	P	183/339 (54%)	159 (87%)	21 (12%)	3 (2%)	8	38
17	Q	428/439 (98%)	321 (75%)	84 (20%)	23 (5%)	1	15
18	R	166/291 (57%)	148 (89%)	16 (10%)	2 (1%)	11	44

Continued on next page...

Continued from previous page...

Mol	Chain	Analysed	Favoured	Allowed	Outliers	Percentiles	
19	S	174/517 (34%)	138 (79%)	26 (15%)	10 (6%)	1	14
20	T	235/249 (94%)	198 (84%)	30 (13%)	7 (3%)	3	23
21	U	168/301 (56%)	135 (80%)	24 (14%)	9 (5%)	1	15
22	0	730/760 (96%)	610 (84%)	95 (13%)	25 (3%)	3	21
23	1	544/548 (99%)	470 (86%)	57 (10%)	17 (3%)	3	22
24	2	451/462 (98%)	370 (82%)	66 (15%)	15 (3%)	3	21
25	3	307/309 (99%)	245 (80%)	50 (16%)	12 (4%)	2	19
26	4	293/308 (95%)	250 (85%)	33 (11%)	10 (3%)	3	21
27	5	64/71 (90%)	61 (95%)	3 (5%)	0	100	100
28	6	383/395 (97%)	321 (84%)	51 (13%)	11 (3%)	3	23
29	7	630/782 (81%)	472 (75%)	124 (20%)	34 (5%)	1	15
30	8	297/346 (86%)	249 (84%)	40 (14%)	8 (3%)	4	25
31	9	274/323 (85%)	247 (90%)	26 (10%)	1 (0%)	30	68
All	All	9834/11828 (83%)	8233 (84%)	1311 (13%)	290 (3%)	6	23

All (290) Ramachandran outliers are listed below:

Mol	Chain	Res	Type
1	A	531	ASN
1	A	935	GLN
1	A	1130	ILE
2	B	841	ARG
7	G	154	LYS
8	H	75	TYR
10	J	2	ILE
12	L	38	GLU
13	M	66	ARG
13	M	86	LYS
17	Q	212	PRO
17	Q	250	TYR
17	Q	379	GLU
18	R	140	LYS
19	S	82	LYS
19	S	85	GLY
19	S	92	ARG
22	0	114	ASN
22	0	152	LEU

Continued on next page...

*Continued from previous page...*

<b>Mol</b>	<b>Chain</b>	<b>Res</b>	<b>Type</b>
22	0	190	CYS
23	1	7	GLU
25	3	7	PRO
25	3	192	LEU
26	4	92	ASN
29	7	47	ASP
29	7	289	TYR
29	7	309	ASP
30	8	33	ASN
30	8	174	VAL
1	A	72	GLN
1	A	257	PRO
1	A	272	ASN
1	A	625	ASP
1	A	1435	THR
2	B	61	ASP
2	B	232	THR
2	B	257	VAL
2	B	262	TYR
2	B	264	LYS
2	B	561	ILE
3	C	2	PRO
3	C	126	ARG
3	C	129	PRO
5	E	121	MET
8	H	21	LYS
8	H	107	GLU
13	M	56	SER
13	M	64	PRO
17	Q	244	PRO
17	Q	292	SER
17	Q	386	GLU
19	S	67	ALA
20	T	157	ALA
21	U	227	GLU
21	U	228	MET
21	U	232	GLU
22	0	47	GLY
22	0	65	LEU
22	0	111	SER
22	0	204	VAL
23	1	36	GLU

*Continued on next page...*

*Continued from previous page...*

<b>Mol</b>	<b>Chain</b>	<b>Res</b>	<b>Type</b>
23	1	162	GLN
23	1	239	SER
23	1	455	ASN
24	2	385	PRO
26	4	218	PRO
26	4	264	ILE
28	6	315	ALA
29	7	34	PRO
29	7	75	PRO
29	7	92	VAL
29	7	115	GLU
29	7	303	ASN
29	7	308	ILE
29	7	555	ASN
30	8	253	PRO
1	A	38	GLU
1	A	49	GLY
1	A	604	ARG
1	A	786	ALA
1	A	1101	GLN
1	A	1106	THR
1	A	1107	PHE
2	B	79	GLU
2	B	181	PRO
2	B	378	GLY
2	B	562	ALA
2	B	873	LEU
2	B	957	THR
3	C	89	THR
3	C	92	GLU
3	C	150	ILE
4	D	57	LEU
5	E	25	GLY
7	G	49	THR
8	H	108	ALA
9	I	105	GLU
10	J	14	VAL
11	K	18	LYS
13	M	95	GLU
13	M	109	SER
14	N	312	GLU
16	P	206	GLU

*Continued on next page...*



*Continued from previous page...*

<b>Mol</b>	<b>Chain</b>	<b>Res</b>	<b>Type</b>
17	Q	203	ILE
17	Q	215	LYS
17	Q	232	GLY
17	Q	275	LYS
17	Q	293	GLU
17	Q	294	ASP
17	Q	347	THR
18	R	92	GLY
21	U	223	MET
22	0	112	ARG
22	0	274	LYS
22	0	306	ALA
22	0	497	ARG
23	1	14	LYS
23	1	166	ILE
23	1	370	LYS
24	2	48	LEU
24	2	76	LYS
24	2	134	SER
24	2	374	PRO
24	2	380	THR
25	3	259	HIS
25	3	261	PRO
26	4	154	ASN
26	4	293	LEU
28	6	314	SER
29	7	53	VAL
29	7	82	GLY
29	7	105	GLU
30	8	85	SER
30	8	104	ASP
1	A	67	ARG
1	A	271	ARG
1	A	609	HIS
1	A	615	SER
1	A	911	PRO
1	A	1252	ALA
1	A	1277	ASP
2	B	37	LYS
2	B	495	LEU
3	C	41	GLU
5	E	49	SER

*Continued on next page...*

*Continued from previous page...*

<b>Mol</b>	<b>Chain</b>	<b>Res</b>	<b>Type</b>
5	E	80	PRO
5	E	107	GLN
6	F	44	ARG
10	J	6	ARG
13	M	90	ALA
17	Q	165	GLU
17	Q	262	GLU
17	Q	368	ARG
19	S	81	ARG
19	S	154	THR
20	T	38	GLY
21	U	212	CYS
21	U	230	SER
21	U	255	GLY
21	U	277	GLN
22	0	19	PRO
22	0	113	LYS
22	0	145	GLN
22	0	148	HIS
22	0	312	ASP
22	0	387	GLU
22	0	420	PRO
22	0	482	THR
22	0	502	VAL
23	1	27	MET
23	1	69	LEU
23	1	83	SER
23	1	213	HIS
23	1	238	GLY
24	2	192	GLU
24	2	246	GLY
24	2	311	THR
24	2	339	PRO
24	2	372	ALA
25	3	43	ALA
25	3	244	ALA
25	3	264	GLU
26	4	243	LEU
28	6	175	THR
28	6	307	ILE
29	7	38	VAL
29	7	123	LEU

*Continued on next page...*

*Continued from previous page...*

<b>Mol</b>	<b>Chain</b>	<b>Res</b>	<b>Type</b>
29	7	150	ASP
29	7	288	GLU
29	7	723	ASP
30	8	84	LYS
30	8	95	GLU
30	8	141	ASN
31	9	241	ASN
1	A	56	GLY
1	A	461	GLN
1	A	479	TRP
1	A	929	ALA
1	A	1117	VAL
1	A	1273	GLU
2	B	563	ASP
2	B	875	GLU
2	B	1006	VAL
3	C	78	ILE
13	M	45	VAL
13	M	84	ILE
13	M	97	GLY
16	P	161	ILE
17	Q	209	THR
17	Q	249	LEU
17	Q	340	VAL
17	Q	355	GLU
17	Q	359	SER
19	S	86	ILE
19	S	151	ARG
19	S	156	THR
20	T	179	ASP
23	1	6	GLU
23	1	220	PHE
23	1	329	THR
23	1	483	THR
24	2	319	THR
25	3	218	VAL
25	3	245	LEU
26	4	100	LYS
26	4	269	SER
28	6	176	THR
28	6	341	GLY
28	6	349	GLN

*Continued on next page...*

*Continued from previous page...*

<b>Mol</b>	<b>Chain</b>	<b>Res</b>	<b>Type</b>
29	7	145	LYS
29	7	172	HIS
29	7	187	HIS
29	7	268	VAL
29	7	648	LYS
1	A	621	ILE
1	A	1274	GLU
2	B	134	LYS
3	C	143	VAL
8	H	76	ASN
19	S	116	GLY
20	T	24	PRO
20	T	145	LEU
22	0	18	TYR
22	0	504	ILE
26	4	242	ILE
28	6	162	HIS
28	6	251	ARG
29	7	126	ALA
29	7	278	GLU
29	7	295	TYR
29	7	317	ARG
29	7	473	GLU
1	A	610	PRO
13	M	11	PRO
16	P	297	LYS
17	Q	286	VAL
21	U	295	GLY
22	0	611	VAL
25	3	267	GLY
28	6	179	PRO
28	6	316	PRO
29	7	306	ILE
1	A	55	GLY
1	A	1179	PRO
2	B	773	PRO
9	I	84	HIS
22	0	607	GLY
24	2	359	ILE
25	3	230	GLY
29	7	106	PRO
29	7	110	PRO

*Continued on next page...*

*Continued from previous page...*

Mol	Chain	Res	Type
29	7	181	HIS
29	7	486	PRO
1	A	1207	ILE
3	C	199	LYS
20	T	50	GLY
24	2	103	GLY
25	3	132	VAL
1	A	498	GLY
1	A	1275	VAL
9	I	58	ILE
17	Q	298	GLY
20	T	156	VAL
22	0	468	PRO
26	4	124	ILE
29	7	129	VAL
1	A	356	GLY
3	C	139	PRO
24	2	165	GLY
1	A	582	PRO

### 5.3.2 Protein sidechains [i](#)

In the following table, the Percentiles column shows the percent sidechain outliers of the chain as a percentile score with respect to all PDB entries followed by that with respect to all EM entries.

The Analysed column shows the number of residues for which the sidechain conformation was analysed, and the total number of residues.

Mol	Chain	Analysed	Rotameric	Outliers	Percentiles	
1	A	1299/1748 (74%)	1293 (100%)	6 (0%)	86	89
2	B	1020/1028 (99%)	1017 (100%)	3 (0%)	91	92
3	C	252/252 (100%)	249 (99%)	3 (1%)	67	78
4	D	119/126 (94%)	119 (100%)	0	100	100
5	E	192/192 (100%)	192 (100%)	0	100	100
6	F	74/111 (67%)	74 (100%)	0	100	100
7	G	152/153 (99%)	151 (99%)	1 (1%)	81	87
8	H	131/131 (100%)	130 (99%)	1 (1%)	79	85
9	I	112/112 (100%)	112 (100%)	0	100	100

*Continued on next page...*

*Continued from previous page...*

Mol	Chain	Analysed	Rotameric	Outliers	Percentiles	
10	J	56/56 (100%)	56 (100%)	0	100	100
11	K	106/106 (100%)	106 (100%)	0	100	100
12	L	43/55 (78%)	43 (100%)	0	100	100
13	M	263/268 (98%)	259 (98%)	4 (2%)	60	75
14	N	105/324 (32%)	105 (100%)	0	100	100
15	O	90/98 (92%)	89 (99%)	1 (1%)	70	80
16	P	159/293 (54%)	159 (100%)	0	100	100
17	Q	365/373 (98%)	360 (99%)	5 (1%)	62	75
18	R	151/261 (58%)	151 (100%)	0	100	100
19	S	154/448 (34%)	150 (97%)	4 (3%)	41	59
20	T	207/218 (95%)	205 (99%)	2 (1%)	73	82
21	U	148/266 (56%)	146 (99%)	2 (1%)	62	75
22	0	638/664 (96%)	627 (98%)	11 (2%)	56	72
23	1	482/484 (100%)	475 (98%)	7 (2%)	60	75
24	2	390/399 (98%)	386 (99%)	4 (1%)	73	82
25	3	283/283 (100%)	280 (99%)	3 (1%)	70	80
26	4	260/272 (96%)	259 (100%)	1 (0%)	89	91
27	5	59/64 (92%)	59 (100%)	0	100	100
28	6	342/352 (97%)	340 (99%)	2 (1%)	84	88
29	7	558/688 (81%)	550 (99%)	8 (1%)	62	75
30	8	259/299 (87%)	259 (100%)	0	100	100
31	9	250/296 (84%)	247 (99%)	3 (1%)	67	78
All	All	8719/10420 (84%)	8648 (99%)	71 (1%)	77	85

All (71) residues with a non-rotameric sidechain are listed below:

Mol	Chain	Res	Type
1	A	152	ASN
1	A	372	ASN
1	A	557	ARG
1	A	677	ASN
1	A	746	ASN
1	A	1306	LYS
2	B	222	ARG

*Continued on next page...*

*Continued from previous page...*

<b>Mol</b>	<b>Chain</b>	<b>Res</b>	<b>Type</b>
2	B	262	TYR
2	B	486	ASN
3	C	32	ASN
3	C	113	ARG
3	C	123	ASN
7	G	24	ASN
8	H	84	ARG
13	M	66	ARG
13	M	93	PHE
13	M	96	PHE
13	M	116	ASN
15	O	63	ASN
17	Q	65	ASN
17	Q	95	ASN
17	Q	209	THR
17	Q	249	LEU
17	Q	277	ARG
19	S	82	LYS
19	S	83	LYS
19	S	89	LYS
19	S	91	PHE
20	T	158	ASN
20	T	177	ARG
21	U	205	ASN
21	U	294	CYS
22	0	88	ARG
22	0	91	LEU
22	0	113	LYS
22	0	143	ARG
22	0	150	THR
22	0	299	ARG
22	0	388	ILE
22	0	502	VAL
22	0	590	ASN
22	0	601	ARG
22	0	695	ARG
23	1	108	ASN
23	1	184	LEU
23	1	232	ARG
23	1	450	ASN
23	1	482	ASN
23	1	520	ASN

*Continued on next page...*

*Continued from previous page...*

Mol	Chain	Res	Type
23	1	528	MET
24	2	11	ARG
24	2	101	LEU
24	2	289	ASN
24	2	340	ASN
25	3	96	ASN
25	3	216	LYS
25	3	219	LYS
26	4	74	LYS
28	6	147	ASN
28	6	159	MET
29	7	32	ASN
29	7	74	ARG
29	7	115	GLU
29	7	198	ARG
29	7	298	ARG
29	7	299	ASN
29	7	307	ASN
29	7	575	LEU
31	9	37	ASN
31	9	119	ASN
31	9	183	ASN

Sometimes sidechains can be flipped to improve hydrogen bonding and reduce clashes. All (80) such sidechains are listed below:

Mol	Chain	Res	Type
1	A	84	HIS
1	A	122	ASN
1	A	188	GLN
1	A	272	ASN
1	A	412	GLN
1	A	529	GLN
1	A	539	GLN
1	A	654	HIS
1	A	704	ASN
1	A	722	ASN
1	A	746	ASN
1	A	913	ASN
1	A	1077	ASN
1	A	1445	HIS
2	B	188	ASN
2	B	486	ASN

*Continued on next page...*



*Continued from previous page...*

<b>Mol</b>	<b>Chain</b>	<b>Res</b>	<b>Type</b>
2	B	582	GLN
2	B	906	GLN
2	B	913	GLN
2	B	1030	ASN
2	B	1073	GLN
2	B	1133	HIS
3	C	114	HIS
3	C	123	ASN
5	E	71	GLN
7	G	24	ASN
11	K	29	ASN
11	K	84	GLN
13	M	116	ASN
13	M	156	ASN
13	M	227	GLN
14	N	359	ASN
17	Q	64	ASN
17	Q	65	ASN
17	Q	95	ASN
17	Q	101	ASN
18	R	95	HIS
19	S	53	ASN
19	S	96	GLN
21	U	197	ASN
21	U	205	ASN
21	U	292	ASN
22	0	21	GLN
22	0	147	GLN
22	0	148	HIS
22	0	452	GLN
22	0	519	ASN
23	1	98	GLN
23	1	108	ASN
23	1	228	HIS
23	1	328	GLN
23	1	334	ASN
23	1	355	GLN
23	1	409	GLN
23	1	450	ASN
23	1	482	ASN
23	1	520	ASN
24	2	15	GLN

*Continued on next page...*

*Continued from previous page...*

Mol	Chain	Res	Type
24	2	177	GLN
25	3	232	HIS
26	4	225	GLN
26	4	237	GLN
28	6	123	ASN
28	6	147	ASN
28	6	235	HIS
28	6	365	ASN
29	7	32	ASN
29	7	299	ASN
29	7	307	ASN
29	7	377	GLN
29	7	497	GLN
29	7	551	HIS
29	7	595	ASN
30	8	113	HIS
30	8	129	HIS
30	8	221	GLN
31	9	37	ASN
31	9	119	ASN
31	9	183	ASN
31	9	257	ASN

### 5.3.3 RNA [i](#)

There are no RNA molecules in this entry.

## 5.4 Non-standard residues in protein, DNA, RNA chains [i](#)

There are no non-standard protein/DNA/RNA residues in this entry.

## 5.5 Carbohydrates [i](#)

There are no oligosaccharides in this entry.

## 5.6 Ligand geometry [i](#)

Of 20 ligands modelled in this entry, 19 are monoatomic - leaving 1 for Mogul analysis.

In the following table, the Counts columns list the number of bonds (or angles) for which Mogul statistics could be retrieved, the number of bonds (or angles) that are observed in the model and

the number of bonds (or angles) that are defined in the Chemical Component Dictionary. The Link column lists molecule types, if any, to which the group is linked. The Z score for a bond length (or angle) is the number of standard deviations the observed value is removed from the expected value. A bond length (or angle) with  $|Z| > 2$  is considered an outlier worth inspection. RMSZ is the root-mean-square of all Z scores of the bond lengths (or angles).

Mol	Type	Chain	Res	Link	Bond lengths			Bond angles		
					Counts	RMSZ	# Z  > 2	Counts	RMSZ	# Z  > 2
36	SF4	0	1000	22	0,12,12	-	-	-		

In the following table, the Chirals column lists the number of chiral outliers, the number of chiral centers analysed, the number of these observed in the model and the number defined in the Chemical Component Dictionary. Similar counts are reported in the Torsion and Rings columns. '-' means no outliers of that kind were identified.

Mol	Type	Chain	Res	Link	Chirals	Torsions	Rings
36	SF4	0	1000	22	-	-	0/6/5/5

There are no bond length outliers.

There are no bond angle outliers.

There are no chirality outliers.

There are no torsion outliers.

There are no ring outliers.

No monomer is involved in short contacts.

## 5.7 Other polymers [i](#)

There are no such residues in this entry.

## 5.8 Polymer linkage issues [i](#)

There are no chain breaks in this entry.

## 6 Map visualisation [i](#)

This section contains visualisations of the EMDB entry EMD-3307. These allow visual inspection of the internal detail of the map and identification of artifacts.

No raw map or half-maps were deposited for this entry and therefore no images, graphs, etc. pertaining to the raw map can be shown.

### 6.1 Orthogonal projections [i](#)

#### 6.1.1 Primary map

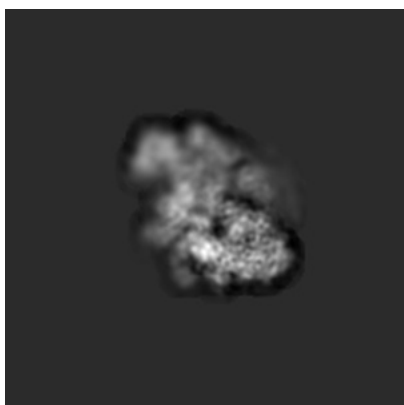

X

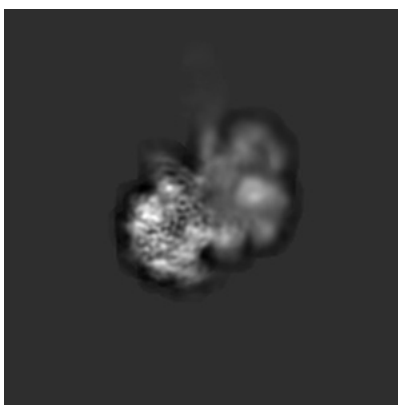

Y

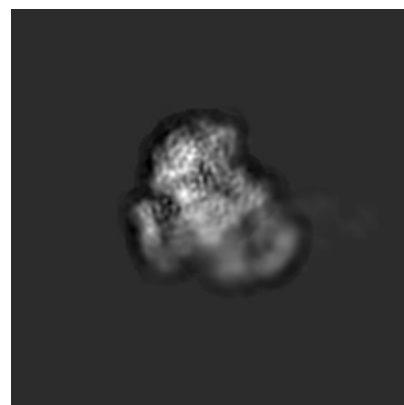

Z

The images above show the map projected in three orthogonal directions.

### 6.2 Central slices [i](#)

#### 6.2.1 Primary map

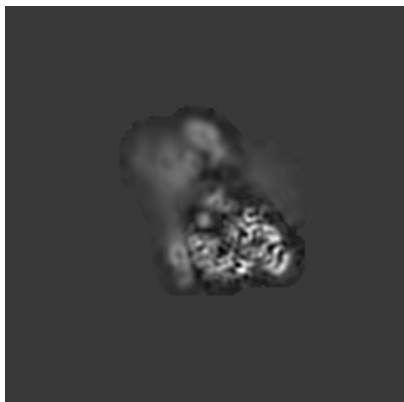

X Index: 96



Y Index: 96

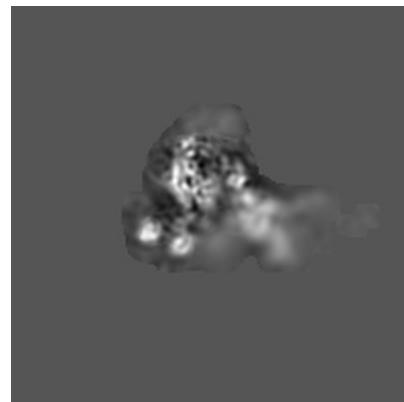

Z Index: 96

The images above show central slices of the map in three orthogonal directions.

## 6.3 Largest variance slices [i](#)

### 6.3.1 Primary map

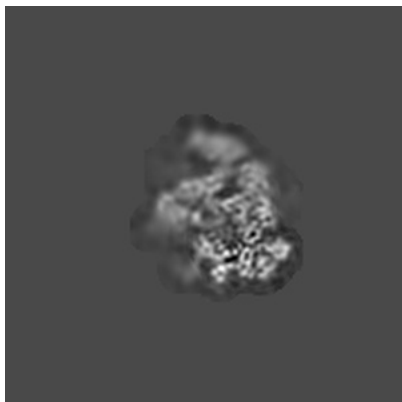

X Index: 83

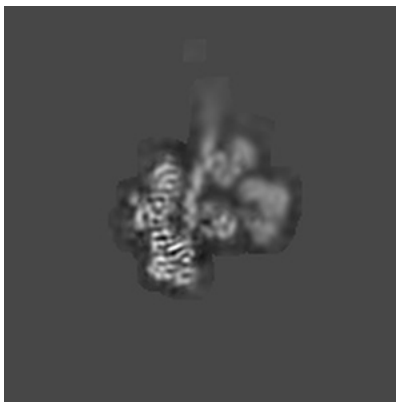

Y Index: 96

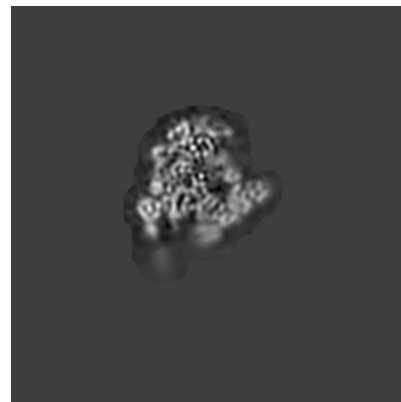

Z Index: 75

The images above show the largest variance slices of the map in three orthogonal directions.

## 6.4 Orthogonal standard-deviation projections (False-color) [i](#)

### 6.4.1 Primary map

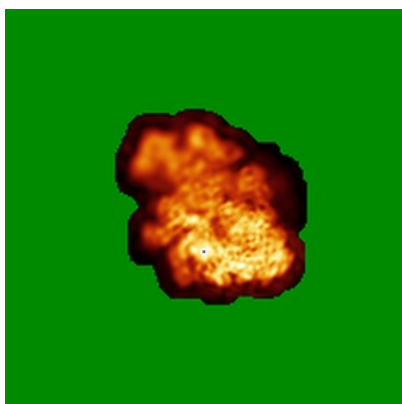

X



Y



Z

The images above show the map standard deviation projections with false color in three orthogonal directions. Minimum values are shown in green, max in blue, and dark to light orange shades represent small to large values respectively.

## 6.5 Orthogonal surface views [i](#)

### 6.5.1 Primary map

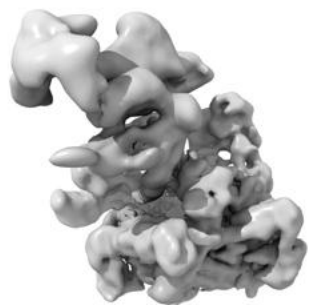

X

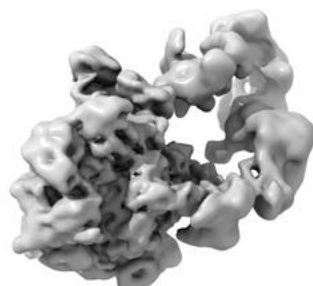

Y

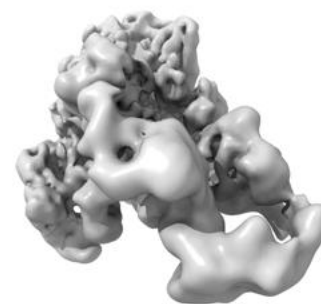

Z

The images above show the 3D surface view of the map at the recommended contour level 0.045. These images, in conjunction with the slice images, may facilitate assessment of whether an appropriate contour level has been provided.

## 6.6 Mask visualisation [i](#)

This section was not generated. No masks/segmentation were deposited.

## 7 Map analysis [i](#)

This section contains the results of statistical analysis of the map.

### 7.1 Map-value distribution [i](#)

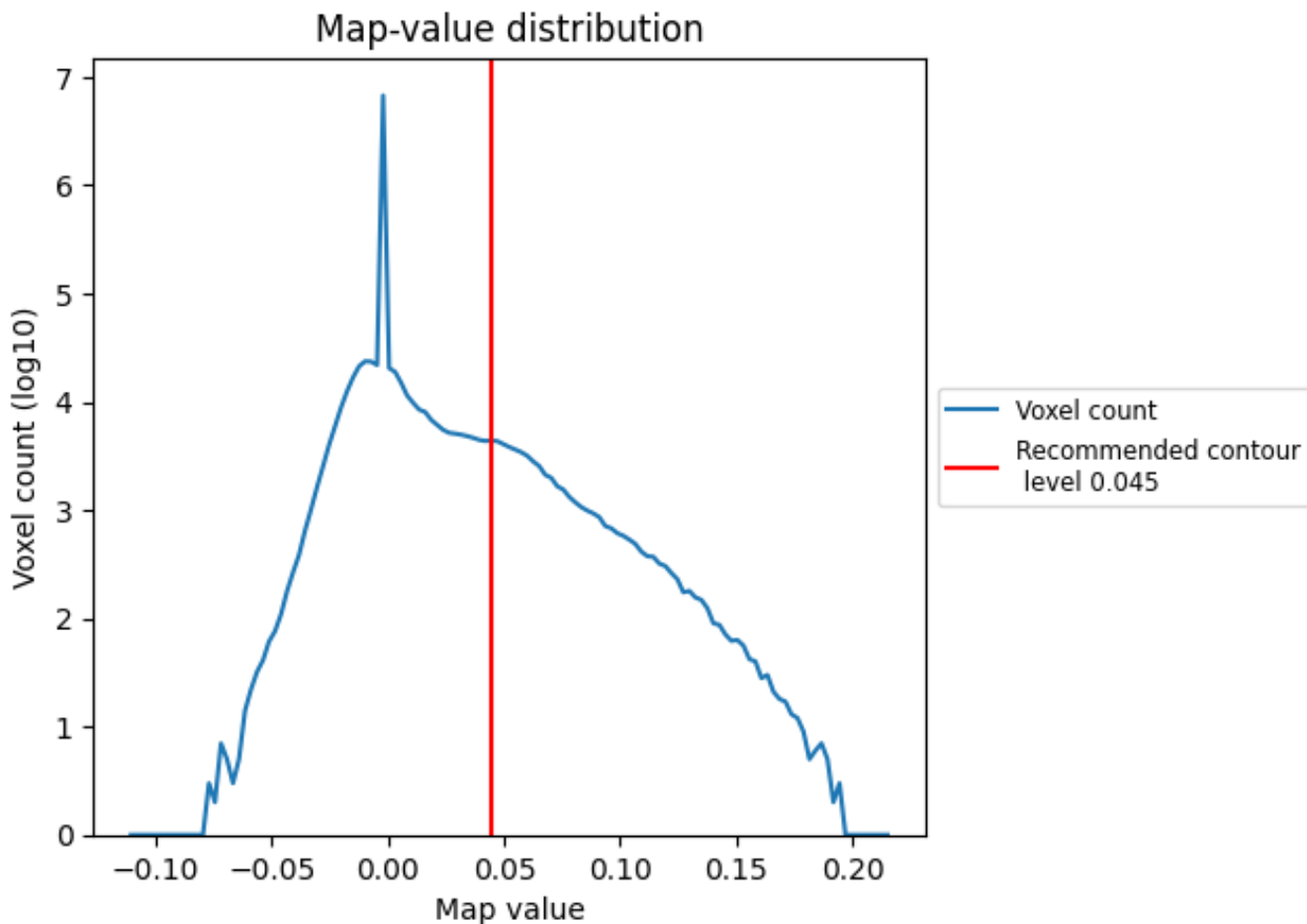

The map-value distribution is plotted in 128 intervals along the x-axis. The y-axis is logarithmic. A spike in this graph at zero usually indicates that the volume has been masked.

## 7.2 Volume estimate [\(i\)](#)

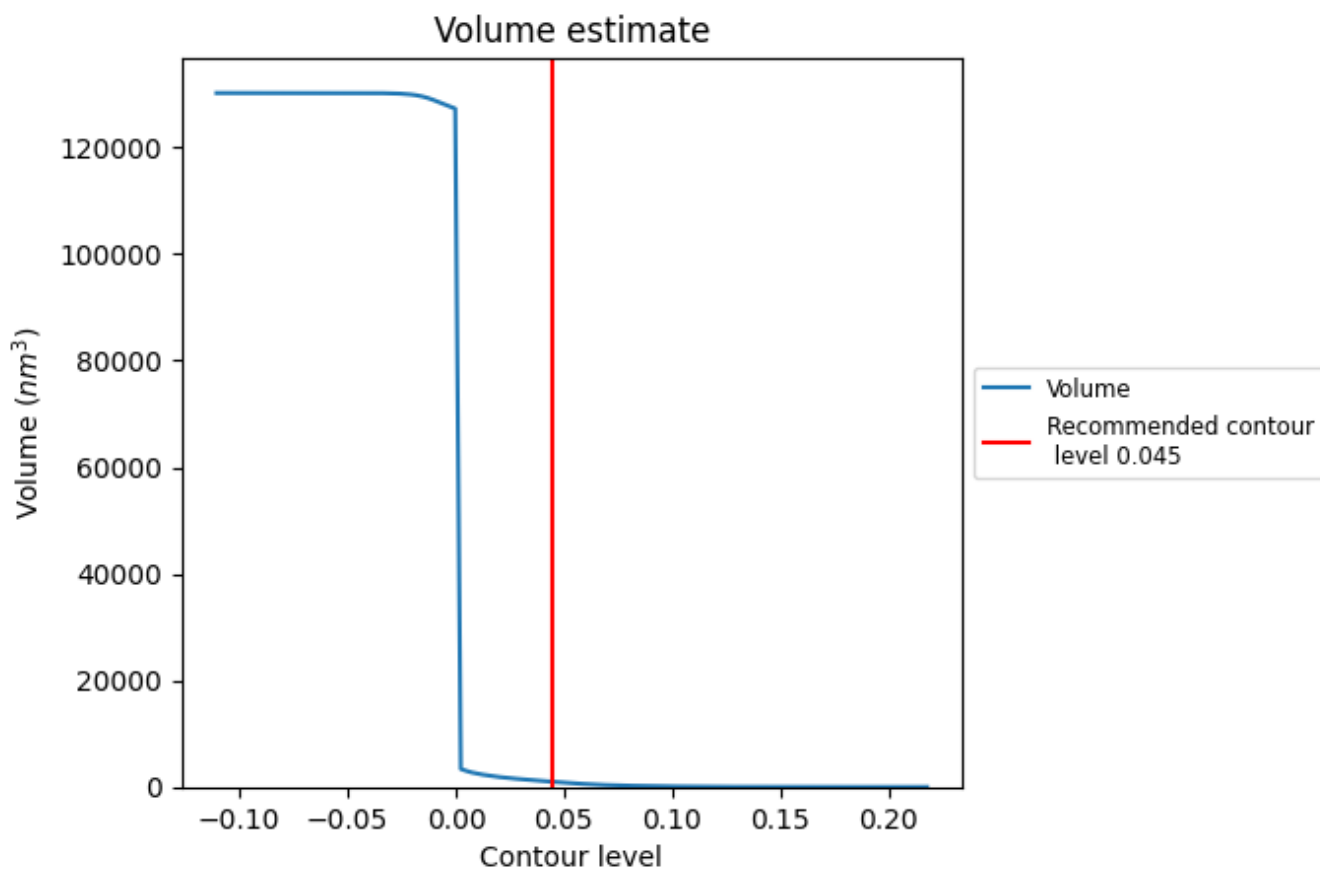

The volume at the recommended contour level is 965 nm<sup>3</sup>; this corresponds to an approximate mass of 872 kDa.

The volume estimate graph shows how the enclosed volume varies with the contour level. The recommended contour level is shown as a vertical line and the intersection between the line and the curve gives the volume of the enclosed surface at the given level.



### 7.3 Rotationally averaged power spectrum [i](#)

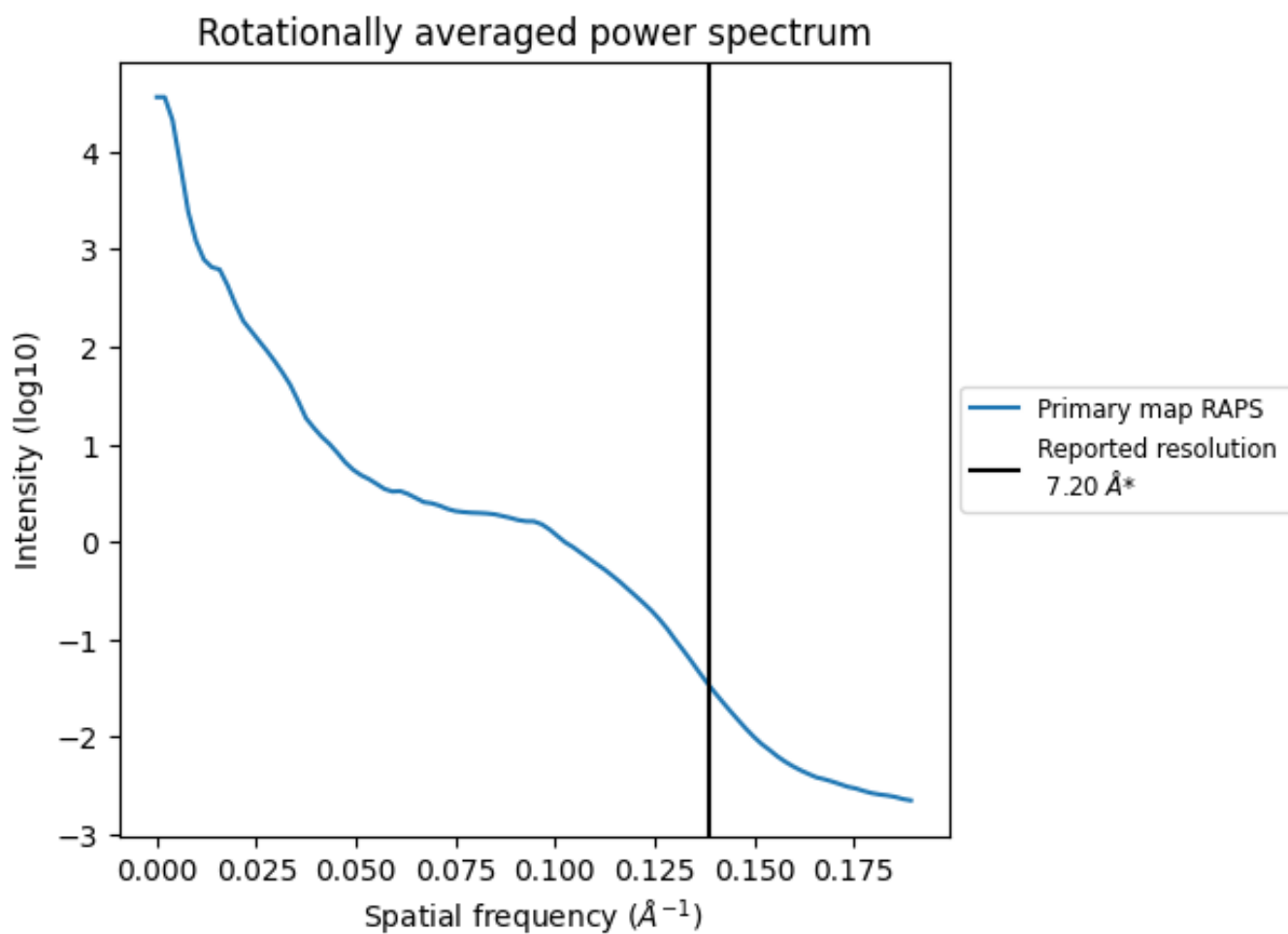

\*Reported resolution corresponds to spatial frequency of 0.139 Å<sup>-1</sup>

## 8 Fourier-Shell correlation [i](#)

Fourier-Shell Correlation (FSC) is the most commonly used method to estimate the resolution of single-particle and subtomogram-averaged maps. The shape of the curve depends on the imposed symmetry, mask and whether or not the two 3D reconstructions used were processed from a common reference. The reported resolution is shown as a black line. A curve is displayed for the half-bit criterion in addition to lines showing the 0.143 gold standard cut-off and 0.5 cut-off.

### 8.1 FSC [i](#)

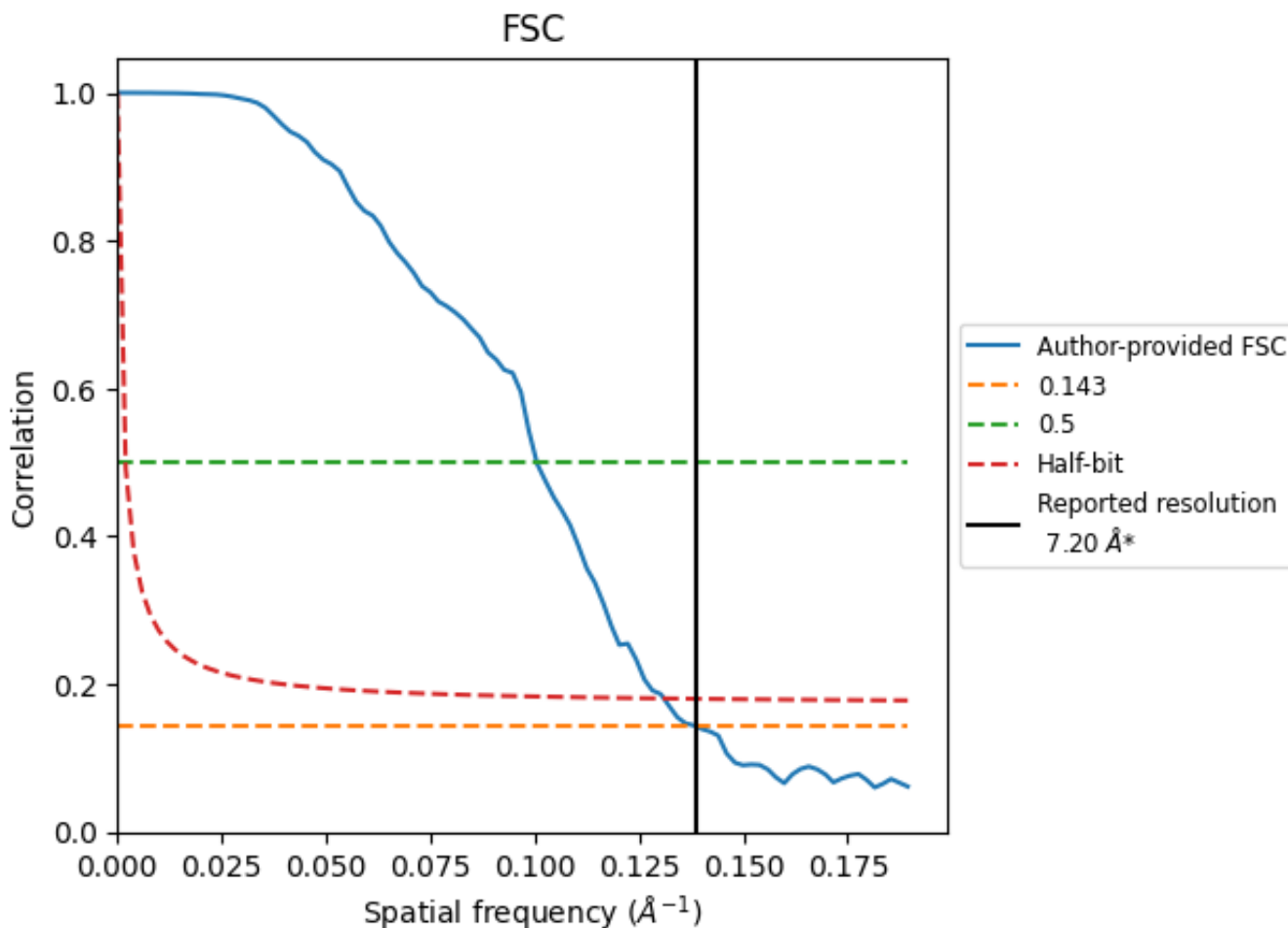

\*Reported resolution corresponds to spatial frequency of 0.139 Å<sup>-1</sup>

## 8.2 Resolution estimates [i](#)

Resolution estimate (Å)	Estimation criterion (FSC cut-off)		
	0.143	0.5	Half-bit
Reported by author	-	-	-
Author-provided FSC curve	7.23	9.95	7.64
Unmasked-calculated*	-	-	-

\*Resolution estimate based on FSC curve calculated by comparison of deposited half-maps.

## 9 Map-model fit [i](#)

This section contains information regarding the fit between EMDB map EMD-3307 and PDB model 6O9L. Per-residue inclusion information can be found in section 3 on page 11.

### 9.1 Map-model overlay [i](#)

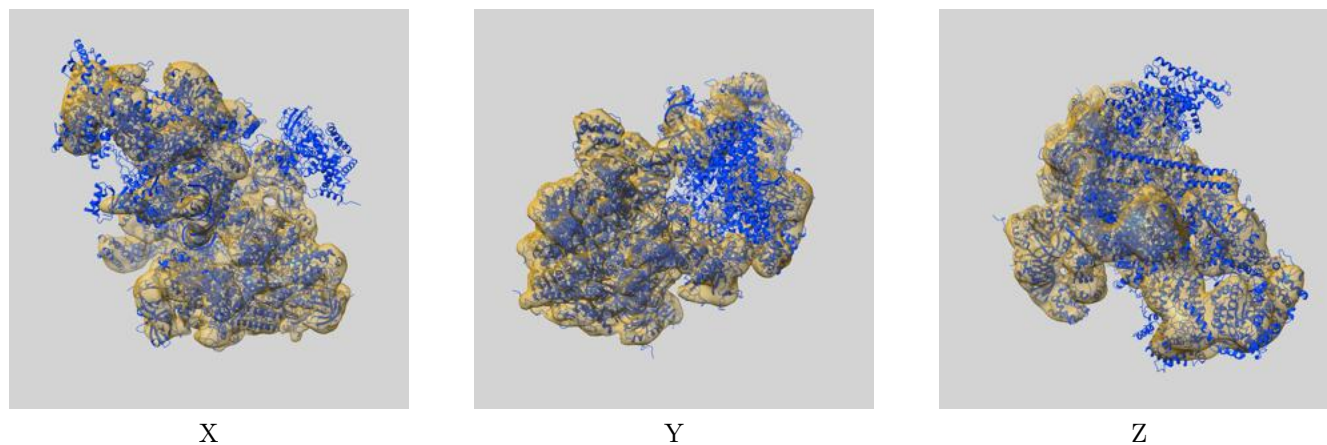

The images above show the 3D surface view of the map at the recommended contour level 0.045 at 50% transparency in yellow overlaid with a ribbon representation of the model coloured in blue. These images allow for the visual assessment of the quality of fit between the atomic model and the map.

## 9.2 Q-score mapped to coordinate model [i](#)

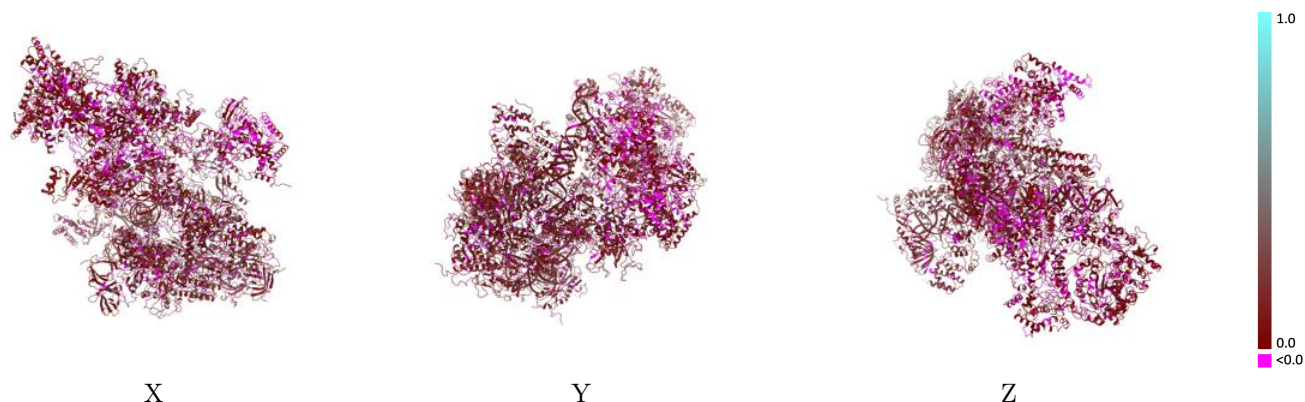

The images above show the model with each residue coloured according to its Q-score. This shows their resolvability in the map with higher Q-score values reflecting better resolvability. Please note: Q-score is calculating the resolvability of atoms, and thus high values are only expected at resolutions at which atoms can be resolved. Low Q-score values may therefore be expected for many entries.

## 9.3 Atom inclusion mapped to coordinate model [i](#)

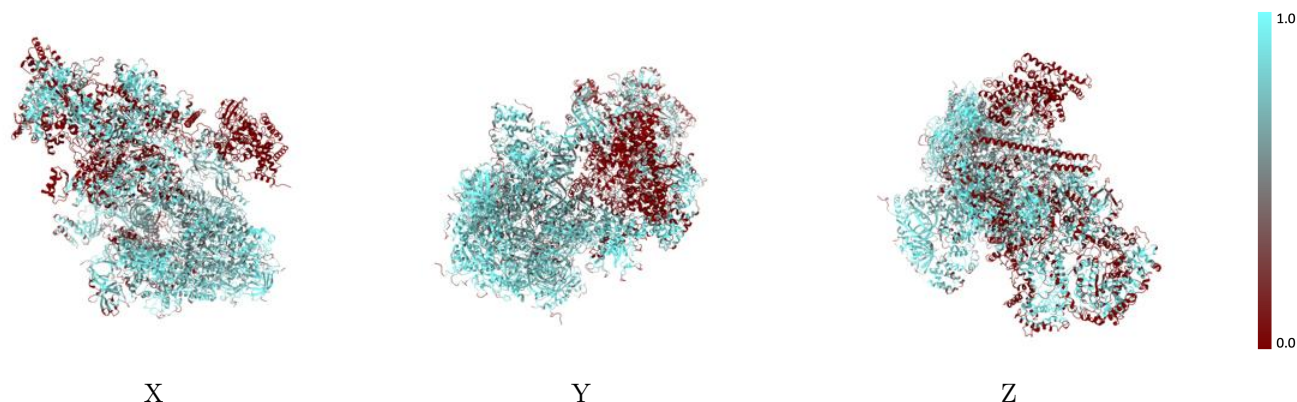

The images above show the model with each residue coloured according to its atom inclusion. This shows to what extent they are inside the map at the recommended contour level (0.045).



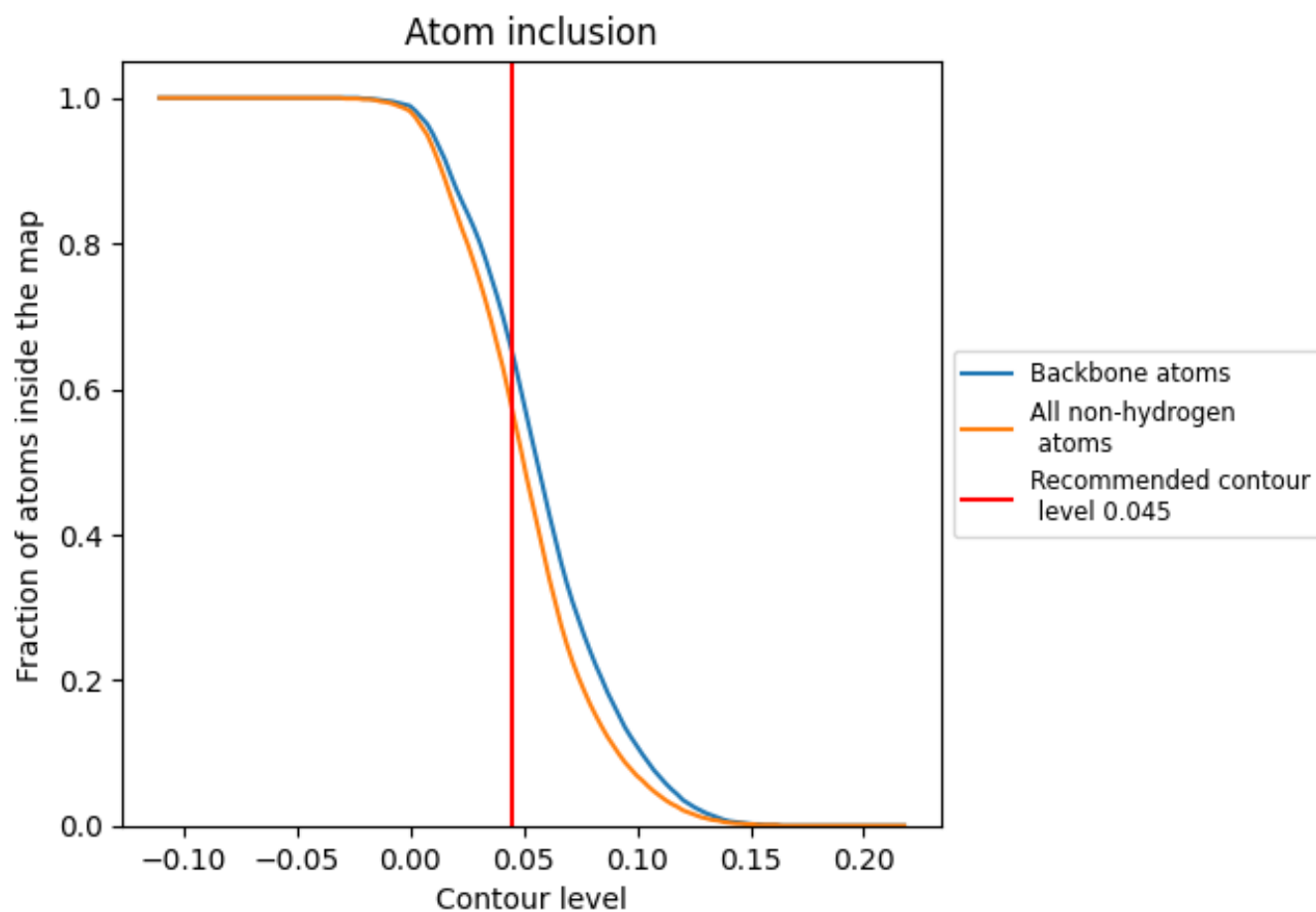

































































## 9.4 Atom inclusion [i](#)



At the recommended contour level, 65% of all backbone atoms, 57% of all non-hydrogen atoms, are inside the map.

## 9.5 Map-model fit summary

The table lists the average atom inclusion at the recommended contour level (0.045) and Q-score for the entire model and for each chain.

Chain	Atom inclusion	Q-score
All	 0.5710	 0.0860
0	 0.6280	 0.0630
1	 0.2340	 0.0320
2	 0.4390	 0.0610
3	 0.1870	 0.0530
4	 0.5390	 0.0560
5	 0.2470	 0.0480
6	 0.6480	 0.0500
7	 0.5080	 0.0540
8	 0.0060	 0.0220
9	 0.0000	 0.0200
A	 0.6700	 0.1180
B	 0.7070	 0.1170
C	 0.8330	 0.1230
D	 0.7080	 0.0990
E	 0.7460	 0.1290
F	 0.7140	 0.1150
G	 0.7890	 0.1010
H	 0.8020	 0.1240
I	 0.7570	 0.1070
J	 0.8120	 0.1160
K	 0.8270	 0.1510
L	 0.8360	 0.1440
M	 0.6330	 0.1020
N	 0.7420	 0.0970
O	 0.7940	 0.1030
P	 0.8560	 0.1030
Q	 0.3210	 0.0560
R	 0.6960	 0.0960
S	 0.4760	 0.0690
T	 0.6340	 0.1010
U	 0.6190	 0.1070
X	 0.7490	 0.1370
Y	 0.7790	 0.1420

