



wwPDB X-ray Structure Validation Summary Report ⓘ

Jun 13, 2022 – 04:07 pm BST

PDB ID : 7OQ2
Title : NaK S-DI mutant soaked in Na⁺
Authors : Minniberger, S.; Plested, A.J.R.
Deposited on : 2021-06-02
Resolution : 1.70 Å(reported)

This is a wwPDB X-ray Structure Validation Summary Report for a publicly released PDB entry.

We welcome your comments at validation@mail.wwpdb.org

A user guide is available at

<https://www.wwpdb.org/validation/2017/XrayValidationReportHelp>

with specific help available everywhere you see the ⓘ symbol.

The following versions of software and data (see [references ⓘ](#)) were used in the production of this report:

MolProbity : 4.02b-467
Mogul : 1.8.4, CSD as541be (2020)
Xtriage (Phenix) : 1.13
EDS : 2.28.1
buster-report : 1.1.7 (2018)
Percentile statistics : 20191225.v01 (using entries in the PDB archive December 25th 2019)
Refmac : 5.8.0267
CCP4 : 7.1.010 (Gargrove)
Ideal geometry (proteins) : Engh & Huber (2001)
Ideal geometry (DNA, RNA) : Parkinson et al. (1996)
Validation Pipeline (wwPDB-VP) : 2.28.1

1 Overall quality at a glance

The following experimental techniques were used to determine the structure:

X-RAY DIFFRACTION

The reported resolution of this entry is 1.70 Å.

Percentile scores (ranging between 0-100) for global validation metrics of the entry are shown in the following graphic. The table shows the number of entries on which the scores are based.

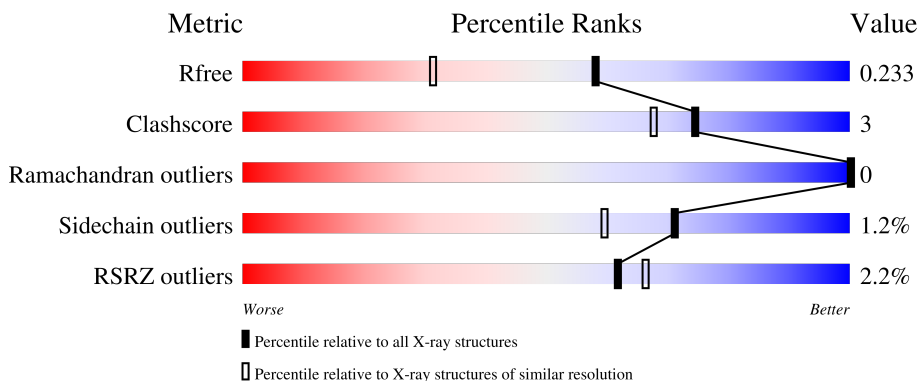

Metric	Whole archive (#Entries)	Similar resolution (#Entries, resolution range(Å))
R_{free}	130704	4298 (1.70-1.70)
Clashscore	141614	4695 (1.70-1.70)
Ramachandran outliers	138981	4610 (1.70-1.70)
Sidechain outliers	138945	4610 (1.70-1.70)
RSRZ outliers	127900	4222 (1.70-1.70)

The table below summarises the geometric issues observed across the polymeric chains and their fit to the electron density. The red, orange, yellow and green segments of the lower bar indicate the fraction of residues that contain outliers for ≥ 3 , 2, 1 and 0 types of geometric quality criteria respectively. A grey segment represents the fraction of residues that are not modelled. The numeric value for each fraction is indicated below the corresponding segment, with a dot representing fractions $\leq 5\%$. The upper red bar (where present) indicates the fraction of residues that have poor fit to the electron density. The numeric value is given above the bar.

Mol	Chain	Length	Quality of chain
1	A	96	
1	B	96	

The following table lists non-polymeric compounds, carbohydrate monomers and non-standard residues in protein, DNA, RNA chains that are outliers for geometric or electron-density-fit criteria:

Mol	Type	Chain	Res	Chirality	Geometry	Clashes	Electron density
2	MPD	B	204	-	-	-	X

2 Entry composition

There are 6 unique types of molecules in this entry. The entry contains 3510 atoms, of which 1792 are hydrogens and 0 are deuteriums.

In the tables below, the ZeroOcc column contains the number of atoms modelled with zero occupancy, the AltConf column contains the number of residues with at least one atom in alternate conformation and the Trace column contains the number of residues modelled with at most 2 atoms.

- Molecule 1 is a protein called Potassium channel protein.

Mol	Chain	Residues	Atoms					ZeroOcc	AltConf	Trace
			Total	C	H	N	O			
1	A	91	1455	479	745	104	127	0	0	0
1	B	95	1554	511	795	114	134	0	3	0

There are 18 discrepancies between the modelled and reference sequences:

Chain	Residue	Modelled	Actual	Comment	Reference
A	18	MET	-	initiating methionine	UNP Q81HW2
A	66	SER	ASP	engineered mutation	UNP Q81HW2
A	?	-	GLY	deletion	UNP Q81HW2
A	67	ASP	ASN	engineered mutation	UNP Q81HW2
A	68	ILE	PHE	engineered mutation	UNP Q81HW2
A	110	LEU	-	expression tag	UNP Q81HW2
A	111	VAL	-	expression tag	UNP Q81HW2
A	112	PRO	-	expression tag	UNP Q81HW2
A	113	ARG	-	expression tag	UNP Q81HW2
B	18	MET	-	initiating methionine	UNP Q81HW2
B	66	SER	ASP	engineered mutation	UNP Q81HW2
B	?	-	GLY	deletion	UNP Q81HW2
B	67	ASP	ASN	engineered mutation	UNP Q81HW2
B	68	ILE	PHE	engineered mutation	UNP Q81HW2
B	110	LEU	-	expression tag	UNP Q81HW2
B	111	VAL	-	expression tag	UNP Q81HW2
B	112	PRO	-	expression tag	UNP Q81HW2
B	113	ARG	-	expression tag	UNP Q81HW2

- Molecule 2 is (4S)-2-METHYL-2,4-PENTANEDIOL (three-letter code: MPD) (formula: C₆H₁₄O₂).



Mol	Chain	Residues	Atoms				ZeroOcc	AltConf
			Total	C	H	O		
2	A	1	22	6	14	2	0	0
2	A	1	22	6	14	2	0	0
2	A	1	22	6	14	2	0	0
2	A	1	22	6	14	2	0	0
2	A	1	22	6	14	2	0	0
2	A	1	22	6	14	2	0	0
2	A	1	22	6	14	2	0	0
2	A	1	22	6	14	2	0	0
2	A	1	22	6	14	2	0	0
2	A	1	22	6	14	2	0	0
2	A	1	22	6	14	2	0	0
2	A	1	22	6	14	2	0	0
2	A	1	22	6	14	2	0	0
2	A	1	22	6	14	2	0	0

Continued on next page...

Continued from previous page...

Mol	Chain	Residues	Atoms				ZeroOcc	AltConf
2	B	1	Total	C	H	O	0	0
			22	6	14	2		
2	B	1	Total	C	H	O	0	0
			22	6	14	2		
2	B	1	Total	C	H	O	0	0
			22	6	14	2		
2	B	1	Total	C	H	O	0	0
			22	6	14	2		

- Molecule 3 is SODIUM ION (three-letter code: NA) (formula: Na) (labeled as "Ligand of Interest" by depositor).

Mol	Chain	Residues	Atoms		ZeroOcc	AltConf
3	A	3	Total	Na	0	0
			3	3		
3	B	1	Total	Na	0	0
			1	1		

- Molecule 4 is POTASSIUM ION (three-letter code: K) (formula: K) (labeled as "Ligand of Interest" by depositor).

Mol	Chain	Residues	Atoms		ZeroOcc	AltConf
4	A	2	Total	K	0	0
			2	2		

- Molecule 5 is CHLORIDE ION (three-letter code: CL) (formula: Cl).

Mol	Chain	Residues	Atoms		ZeroOcc	AltConf
5	A	1	Total	Cl	0	0
			1	1		
5	B	1	Total	Cl	0	0
			1	1		

- Molecule 6 is water.

Mol	Chain	Residues	Atoms		ZeroOcc	AltConf
6	A	45	Total	O	0	0
			45	45		
6	B	50	Total	O	0	2
			52	52		

3 Residue-property plots [i](#)

These plots are drawn for all protein, RNA, DNA and oligosaccharide chains in the entry. The first graphic for a chain summarises the proportions of the various outlier classes displayed in the second graphic. The second graphic shows the sequence view annotated by issues in geometry and electron density. Residues are color-coded according to the number of geometric quality criteria for which they contain at least one outlier: green = 0, yellow = 1, orange = 2 and red = 3 or more. A red dot above a residue indicates a poor fit to the electron density ($RSRZ > 2$). Stretches of 2 or more consecutive residues without any outlier are shown as a green connector. Residues present in the sample, but not in the model, are shown in grey.

- Molecule 1: Potassium channel protein

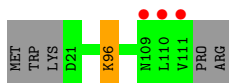

- Molecule 1: Potassium channel protein

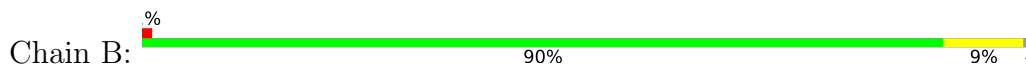

4 Data and refinement statistics

Property	Value	Source
Space group	C 2 2 21	Depositor
Cell constants a, b, c, α , β , γ	81.20Å 88.17Å 49.39Å 90.00° 90.00° 90.00°	Depositor
Resolution (Å)	59.73 – 1.70 59.73 – 1.70	Depositor EDS
% Data completeness (in resolution range)	99.8 (59.73-1.70) 99.9 (59.73-1.70)	Depositor EDS
R_{merge}	0.07	Depositor
R_{sym}	(Not available)	Depositor
$\langle I/\sigma(I) \rangle$ ¹	1.18 (at 1.70Å)	Xtriage
Refinement program	PHENIX 1.19_4092	Depositor
R, R_{free}	0.186 , 0.233 0.186 , 0.233	Depositor DCC
R_{free} test set	1970 reflections (9.91%)	wwPDB-VP
Wilson B-factor (Å ²)	21.8	Xtriage
Anisotropy	0.515	Xtriage
Bulk solvent k_{sol} (e/Å ³), B_{sol} (Å ²)	(Not available) , (Not available)	EDS
L-test for twinning ²	$\langle L \rangle = 0.51$, $\langle L^2 \rangle = 0.35$	Xtriage
Estimated twinning fraction	No twinning to report.	Xtriage
F_o, F_c correlation	0.96	EDS
Total number of atoms	3510	wwPDB-VP
Average B, all atoms (Å ²)	35.0	wwPDB-VP

Xtriage's analysis on translational NCS is as follows: *The largest off-origin peak in the Patterson function is 10.10% of the height of the origin peak. No significant pseudotranslation is detected.*

¹Intensities estimated from amplitudes.

²Theoretical values of $\langle |L| \rangle$, $\langle L^2 \rangle$ for acentric reflections are 0.5, 0.333 respectively for untwinned datasets, and 0.375, 0.2 for perfectly twinned datasets.

5 Model quality

5.1 Standard geometry

Bond lengths and bond angles in the following residue types are not validated in this section: NA, K, MPD, CL

The Z score for a bond length (or angle) is the number of standard deviations the observed value is removed from the expected value. A bond length (or angle) with $|Z| > 5$ is considered an outlier worth inspection. RMSZ is the root-mean-square of all Z scores of the bond lengths (or angles).

Mol	Chain	Bond lengths		Bond angles	
		RMSZ	# Z >5	RMSZ	# Z >5
1	A	0.44	0/725	0.50	0/989
1	B	0.44	0/780	0.49	0/1062
All	All	0.44	0/1505	0.50	0/2051

There are no bond length outliers.

There are no bond angle outliers.

There are no chirality outliers.

There are no planarity outliers.

5.2 Too-close contacts

In the following table, the Non-H and H(model) columns list the number of non-hydrogen atoms and hydrogen atoms in the chain respectively. The H(added) column lists the number of hydrogen atoms added and optimized by MolProbity. The Clashes column lists the number of clashes within the asymmetric unit, whereas Symm-Clashes lists symmetry-related clashes.

Mol	Chain	Non-H	H(model)	H(added)	Clashes	Symm-Clashes
1	A	710	745	744	1	0
1	B	759	795	789	6	0
2	A	112	196	196	4	0
2	B	32	56	56	2	0
3	A	3	0	0	0	0
3	B	1	0	0	0	0
4	A	2	0	0	0	0
5	A	1	0	0	0	0
5	B	1	0	0	0	0
6	A	45	0	0	1	0
6	B	52	0	0	1	1
All	All	1718	1792	1785	11	1

The all-atom clashscore is defined as the number of clashes found per 1000 atoms (including hydrogen atoms). The all-atom clashscore for this structure is 3.

The worst 5 of 11 close contacts within the same asymmetric unit are listed below, sorted by their clash magnitude.

Atom-1	Atom-2	Interatomic distance (Å)	Clash overlap (Å)
2:A:204:MPD:H52	2:A:204:MPD:HM2	1.59	0.83
2:A:208:MPD:H53	2:A:208:MPD:H11	1.73	0.69
1:A:96:LYS:NZ	6:A:302:HOH:O	2.38	0.56
2:A:201:MPD:O2	2:A:201:MPD:O4	2.36	0.44
2:A:208:MPD:H11	2:A:208:MPD:C5	2.45	0.44

All (1) symmetry-related close contacts are listed below. The label for Atom-2 includes the symmetry operator and encoded unit-cell translations to be applied.

Atom-1	Atom-2	Interatomic distance (Å)	Clash overlap (Å)
6:B:344:HOH:O	6:B:344:HOH:O[4_564]	2.13	0.07

5.3 Torsion angles [i](#)

5.3.1 Protein backbone [i](#)

In the following table, the Percentiles column shows the percent Ramachandran outliers of the chain as a percentile score with respect to all X-ray entries followed by that with respect to entries of similar resolution.

The Analysed column shows the number of residues for which the backbone conformation was analysed, and the total number of residues.

Mol	Chain	Analysed	Favoured	Allowed	Outliers	Percentiles	
1	A	89/96 (93%)	88 (99%)	1 (1%)	0	100	100
1	B	96/96 (100%)	96 (100%)	0	0	100	100
All	All	185/192 (96%)	184 (100%)	1 (0%)	0	100	100

There are no Ramachandran outliers to report.

5.3.2 Protein sidechains [i](#)

In the following table, the Percentiles column shows the percent sidechain outliers of the chain as a percentile score with respect to all X-ray entries followed by that with respect to entries of similar resolution.

The Analysed column shows the number of residues for which the sidechain conformation was analysed, and the total number of residues.

Mol	Chain	Analysed	Rotameric	Outliers	Percentiles	
1	A	82/87 (94%)	81 (99%)	1 (1%)	71	59
1	B	87/87 (100%)	86 (99%)	1 (1%)	73	63
All	All	169/174 (97%)	167 (99%)	2 (1%)	71	59

All (2) residues with a non-rotameric sidechain are listed below:

Mol	Chain	Res	Type
1	A	96	LYS
1	B	22	LYS

Sometimes sidechains can be flipped to improve hydrogen bonding and reduce clashes. There are no such sidechains identified.

5.3.3 RNA [i](#)

There are no RNA molecules in this entry.

5.4 Non-standard residues in protein, DNA, RNA chains [i](#)

There are no non-standard protein/DNA/RNA residues in this entry.

5.5 Carbohydrates [i](#)

There are no monosaccharides in this entry.

5.6 Ligand geometry [i](#)

Of 26 ligands modelled in this entry, 8 are monoatomic - leaving 18 for Mogul analysis.

In the following table, the Counts columns list the number of bonds (or angles) for which Mogul statistics could be retrieved, the number of bonds (or angles) that are observed in the model and the number of bonds (or angles) that are defined in the Chemical Component Dictionary. The Link column lists molecule types, if any, to which the group is linked. The Z score for a bond length (or angle) is the number of standard deviations the observed value is removed from the expected value. A bond length (or angle) with $|Z| > 2$ is considered an outlier worth inspection. RMSZ is the root-mean-square of all Z scores of the bond lengths (or angles).

Mol	Type	Chain	Res	Link	Bond lengths			Bond angles		
					Counts	RMSZ	# Z > 2	Counts	RMSZ	# Z > 2
2	MPD	A	211	-	7,7,7	0.83	0	9,10,10	0.66	0
2	MPD	B	203	-	7,7,7	1.29	1 (14%)	9,10,10	0.85	0
2	MPD	A	207	-	7,7,7	0.90	0	9,10,10	0.68	0
2	MPD	A	214	-	7,7,7	0.75	0	9,10,10	0.48	0
2	MPD	B	202	-	7,7,7	0.97	0	9,10,10	0.74	0
2	MPD	A	204	-	7,7,7	1.22	1 (14%)	9,10,10	0.48	0
2	MPD	A	208	-	7,7,7	1.02	0	9,10,10	0.60	0
2	MPD	A	210	-	7,7,7	1.40	2 (28%)	9,10,10	0.67	0
2	MPD	B	201	-	7,7,7	0.84	0	9,10,10	0.64	0
2	MPD	A	209	-	7,7,7	0.95	0	9,10,10	0.79	0
2	MPD	A	212	-	7,7,7	0.82	0	9,10,10	0.58	0
2	MPD	A	213	-	7,7,7	0.99	1 (14%)	9,10,10	0.66	0
2	MPD	A	201	-	7,7,7	0.82	0	9,10,10	0.52	0
2	MPD	A	206	-	7,7,7	0.72	0	9,10,10	0.53	0
2	MPD	A	205	-	7,7,7	0.81	0	9,10,10	0.54	0
2	MPD	B	204	-	7,7,7	0.95	0	9,10,10	0.61	0
2	MPD	A	203	-	7,7,7	1.05	0	9,10,10	0.63	0
2	MPD	A	202	-	7,7,7	1.17	1 (14%)	9,10,10	0.63	0

In the following table, the Chirals column lists the number of chiral outliers, the number of chiral centers analysed, the number of these observed in the model and the number defined in the Chemical Component Dictionary. Similar counts are reported in the Torsion and Rings columns. '-' means no outliers of that kind were identified.

Mol	Type	Chain	Res	Link	Chirals	Torsions	Rings
2	MPD	A	211	-	-	1/5/5/5	-
2	MPD	B	203	-	-	2/5/5/5	-
2	MPD	A	207	-	-	0/5/5/5	-
2	MPD	A	214	-	-	2/5/5/5	-
2	MPD	B	202	-	-	0/5/5/5	-
2	MPD	A	204	-	-	1/5/5/5	-
2	MPD	A	208	-	-	1/5/5/5	-
2	MPD	A	210	-	-	3/5/5/5	-
2	MPD	B	201	-	-	2/5/5/5	-
2	MPD	A	209	-	-	0/5/5/5	-
2	MPD	A	212	-	-	2/5/5/5	-
2	MPD	A	213	-	-	2/5/5/5	-
2	MPD	A	201	-	-	3/5/5/5	-
2	MPD	A	206	-	-	0/5/5/5	-
2	MPD	A	205	-	-	0/5/5/5	-

Continued on next page...

Continued from previous page...

Mol	Type	Chain	Res	Link	Chirals	Torsions	Rings
2	MPD	B	204	-	-	3/5/5/5	-
2	MPD	A	203	-	-	2/5/5/5	-
2	MPD	A	202	-	-	0/5/5/5	-

The worst 5 of 6 bond length outliers are listed below:

Mol	Chain	Res	Type	Atoms	Z	Observed(Å)	Ideal(Å)
2	A	202	MPD	O2-C2	-2.55	1.38	1.44
2	A	210	MPD	O2-C2	-2.46	1.38	1.44
2	B	203	MPD	O2-C2	-2.28	1.38	1.44
2	A	204	MPD	O2-C2	-2.23	1.39	1.44
2	A	213	MPD	O2-C2	-2.13	1.39	1.44

There are no bond angle outliers.

There are no chirality outliers.

5 of 24 torsion outliers are listed below:

Mol	Chain	Res	Type	Atoms
2	A	204	MPD	C2-C3-C4-O4
2	A	210	MPD	CM-C2-C3-C4
2	A	213	MPD	C2-C3-C4-C5
2	B	203	MPD	C2-C3-C4-O4
2	A	201	MPD	O2-C2-C3-C4

There are no ring outliers.

5 monomers are involved in 6 short contacts:

Mol	Chain	Res	Type	Clashes	Symm-Clashes
2	B	202	MPD	1	0
2	A	204	MPD	1	0
2	A	208	MPD	2	0
2	B	201	MPD	1	0
2	A	201	MPD	1	0

5.7 Other polymers [i](#)

There are no such residues in this entry.

5.8 Polymer linkage issues

There are no chain breaks in this entry.

6 Fit of model and data [i](#)

6.1 Protein, DNA and RNA chains [i](#)

In the following table, the column labelled '#RSRZ > 2' contains the number (and percentage) of RSRZ outliers, followed by percent RSRZ outliers for the chain as percentile scores relative to all X-ray entries and entries of similar resolution. The OWAB column contains the minimum, median, 95th percentile and maximum values of the occupancy-weighted average B-factor per residue. The column labelled 'Q < 0.9' lists the number of (and percentage) of residues with an average occupancy less than 0.9.

Mol	Chain	Analysed	<RSRZ>	#RSRZ>2	OWAB(Å ²)	Q<0.9
1	A	91/96 (94%)	-0.05	3 (3%) 46 51	14, 24, 47, 83	0
1	B	95/96 (98%)	-0.08	1 (1%) 80 83	17, 25, 48, 71	0
All	All	186/192 (96%)	-0.07	4 (2%) 62 66	14, 25, 48, 83	0

All (4) RSRZ outliers are listed below:

Mol	Chain	Res	Type	RSRZ
1	A	110	LEU	4.8
1	B	19	TRP	2.8
1	A	111	VAL	2.6
1	A	109	ASN	2.6

6.2 Non-standard residues in protein, DNA, RNA chains [i](#)

There are no non-standard protein/DNA/RNA residues in this entry.

6.3 Carbohydrates [i](#)

There are no monosaccharides in this entry.

6.4 Ligands [i](#)

In the following table, the Atoms column lists the number of modelled atoms in the group and the number defined in the chemical component dictionary. The B-factors column lists the minimum, median, 95th percentile and maximum values of B factors of atoms in the group. The column labelled 'Q < 0.9' lists the number of atoms with occupancy less than 0.9.

Mol	Type	Chain	Res	Atoms	RSCC	RSR	B-factors(Å ²)	Q<0.9
2	MPD	B	204	8/8	0.56	0.57	42,55,64,77	22

Continued on next page...

Continued from previous page...

Mol	Type	Chain	Res	Atoms	RSCC	RSR	B-factors(Å ²)	Q<0.9
2	MPD	A	214	8/8	0.69	0.37	54,70,101,101	22
2	MPD	A	213	8/8	0.69	0.40	51,68,87,88	22
2	MPD	A	210	8/8	0.71	0.27	48,70,95,95	0
2	MPD	A	207	8/8	0.72	0.33	44,65,81,85	0
2	MPD	A	212	8/8	0.75	0.36	49,63,72,90	22
2	MPD	A	209	8/8	0.76	0.28	47,65,70,77	0
2	MPD	A	208	8/8	0.77	0.21	53,66,87,87	0
2	MPD	A	204	8/8	0.79	0.24	63,79,88,88	0
2	MPD	A	203	8/8	0.81	0.33	67,92,117,117	0
2	MPD	A	211	8/8	0.82	0.26	52,75,78,85	0
3	NA	A	217	1/1	0.83	0.34	30,30,30,30	1
2	MPD	A	205	8/8	0.87	0.21	39,56,78,78	0
2	MPD	B	202	8/8	0.87	0.18	35,52,54,79	0
2	MPD	A	206	8/8	0.88	0.15	44,57,67,77	0
2	MPD	A	202	8/8	0.88	0.25	44,60,87,87	0
2	MPD	B	201	8/8	0.89	0.15	24,30,37,40	0
3	NA	A	215	1/1	0.91	0.19	38,38,38,38	1
2	MPD	B	203	8/8	0.91	0.19	45,57,81,81	0
2	MPD	A	201	8/8	0.92	0.17	40,50,64,64	0
3	NA	A	216	1/1	0.93	0.14	40,40,40,40	1
5	CL	B	206	1/1	0.93	0.11	40,40,40,40	0
3	NA	B	205	1/1	0.95	0.07	41,41,41,41	1
5	CL	A	220	1/1	0.97	0.05	31,31,31,31	0
4	K	A	218	1/1	0.99	0.09	21,21,21,21	1
4	K	A	219	1/1	0.99	0.09	14,14,14,14	1

The following is a graphical depiction of the model fit to experimental electron density of all instances of the Ligand of Interest. In addition, ligands with molecular weight > 250 and outliers as shown on the geometry validation Tables will also be included. Each fit is shown from different orientation to approximate a three-dimensional view.

Electron density around NA A 217:

$2mF_o-DF_c$ (at 0.7 rmsd) in gray
 mF_o-DF_c (at 3 rmsd) in purple (negative)
and green (positive)

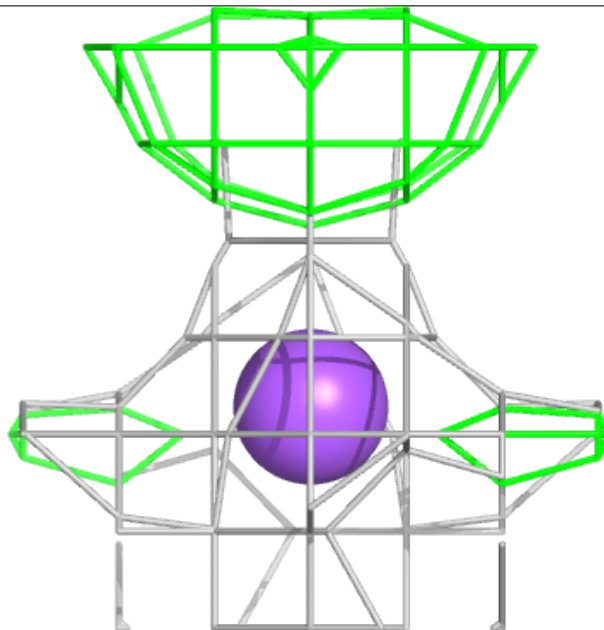
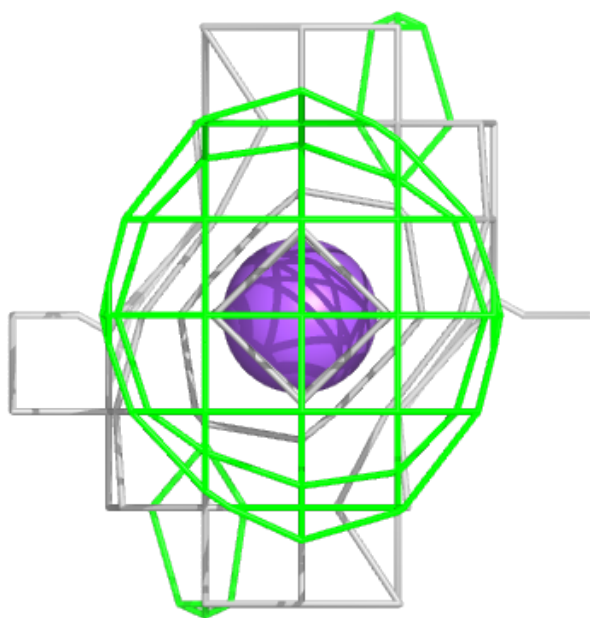
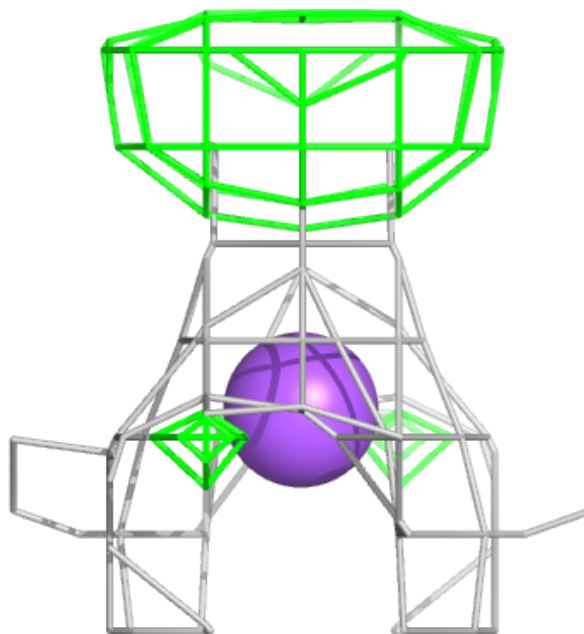

Electron density around NA A 215:

$2mF_o-DF_c$ (at 0.7 rmsd) in gray
 mF_o-DF_c (at 3 rmsd) in purple (negative)
and green (positive)

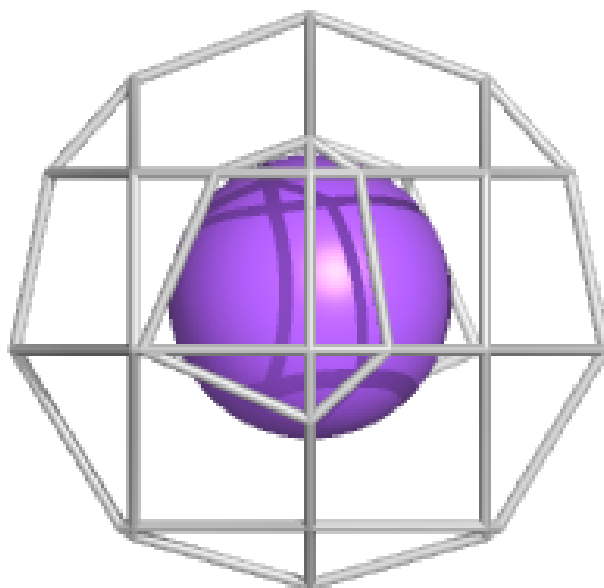
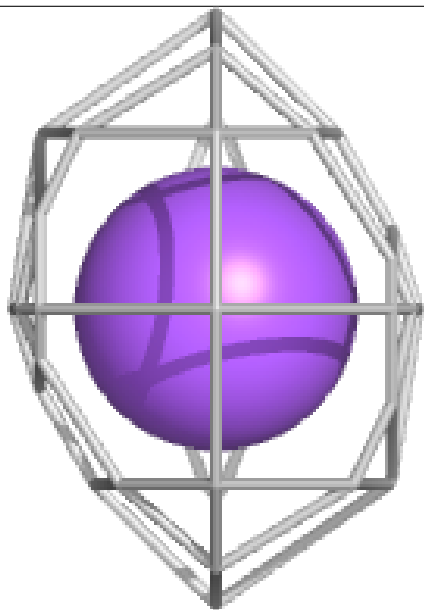
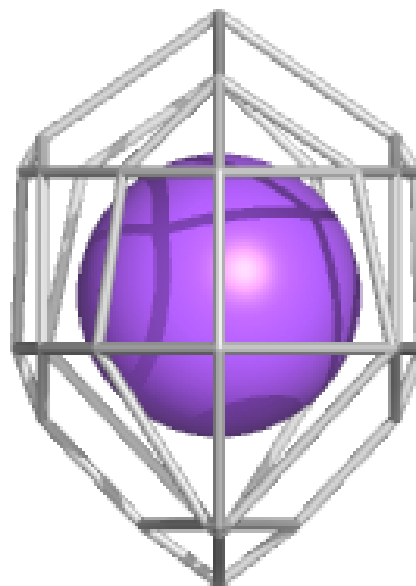

Electron density around NA A 216:

$2mF_o-DF_c$ (at 0.7 rmsd) in gray
 mF_o-DF_c (at 3 rmsd) in purple (negative)
and green (positive)

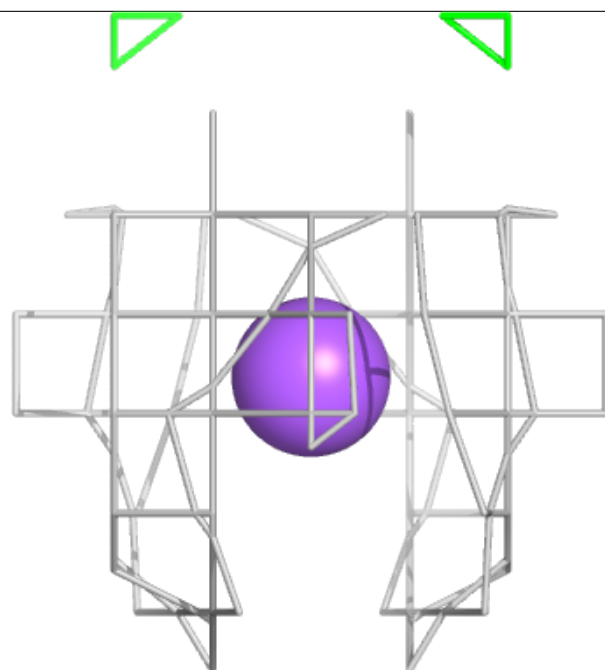
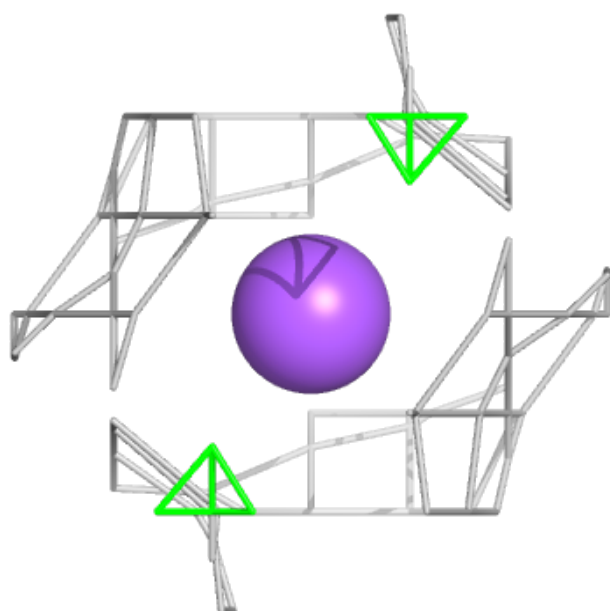
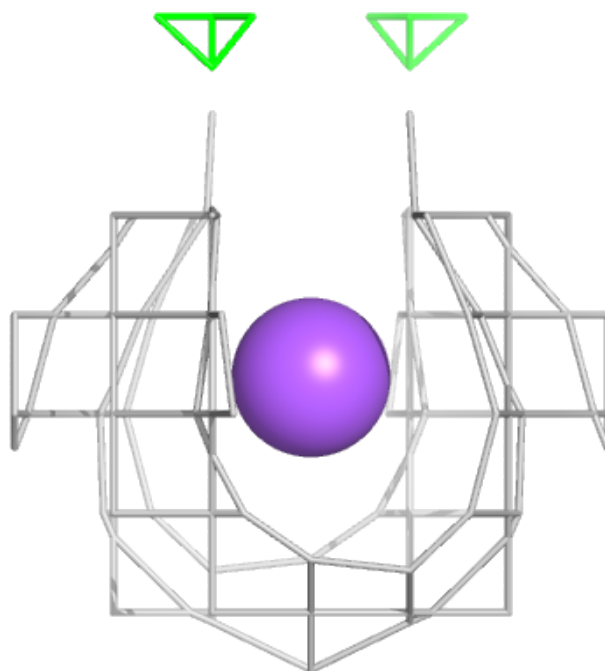

Electron density around NA B 205:

$2mF_o-DF_c$ (at 0.7 rmsd) in gray
 mF_o-DF_c (at 3 rmsd) in purple (negative)
and green (positive)

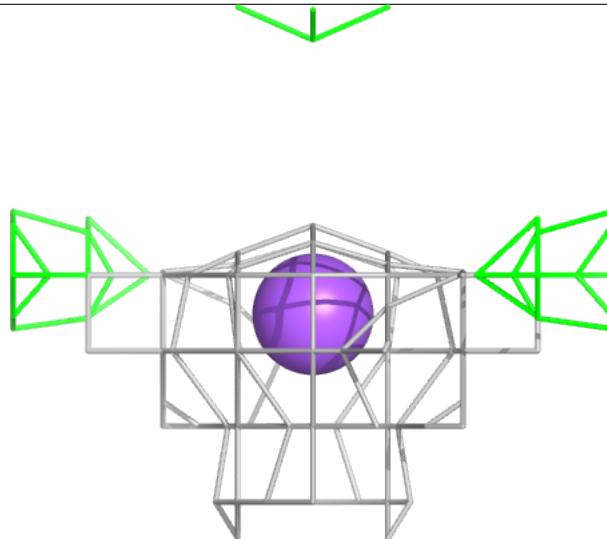
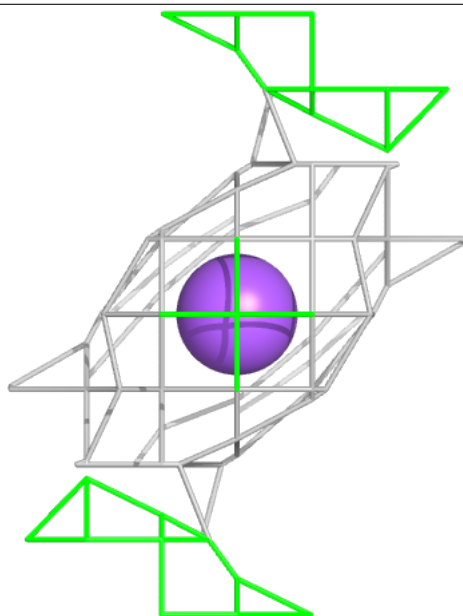
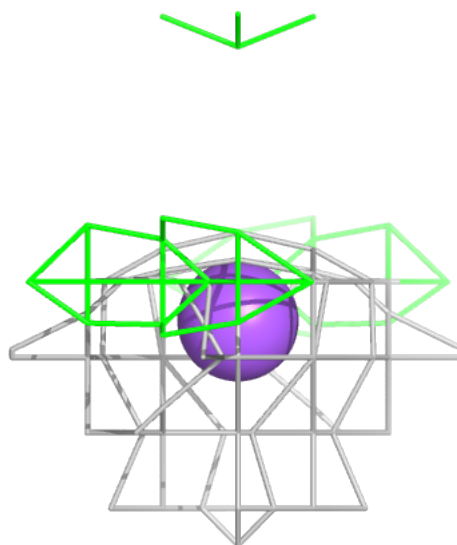

Electron density around K A 218:

$2mF_o-DF_c$ (at 0.7 rmsd) in gray
 mF_o-DF_c (at 3 rmsd) in purple (negative)
and green (positive)

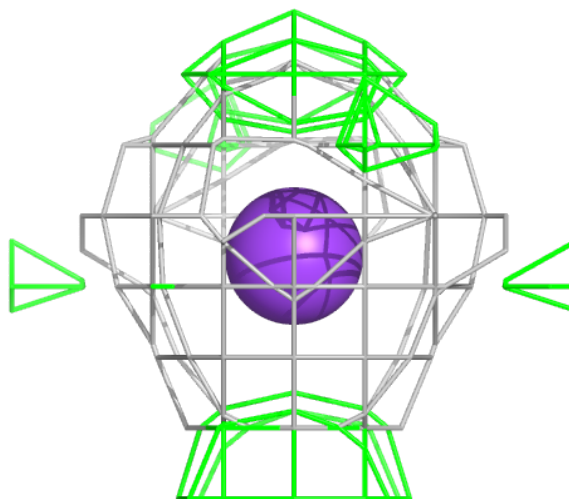
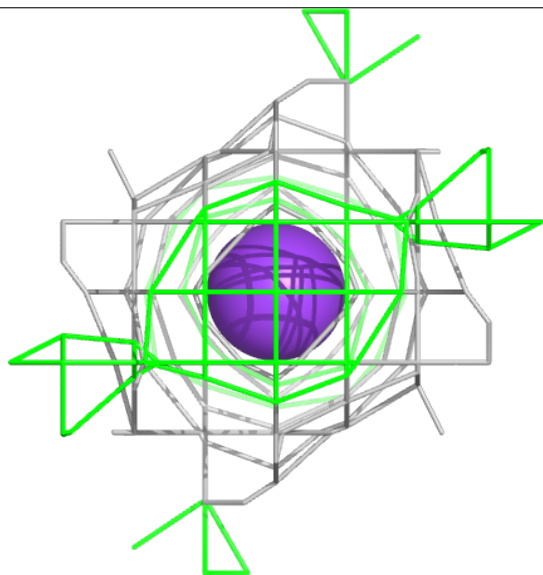
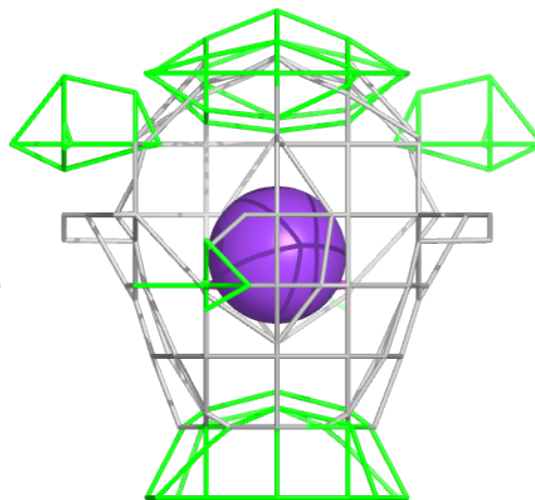

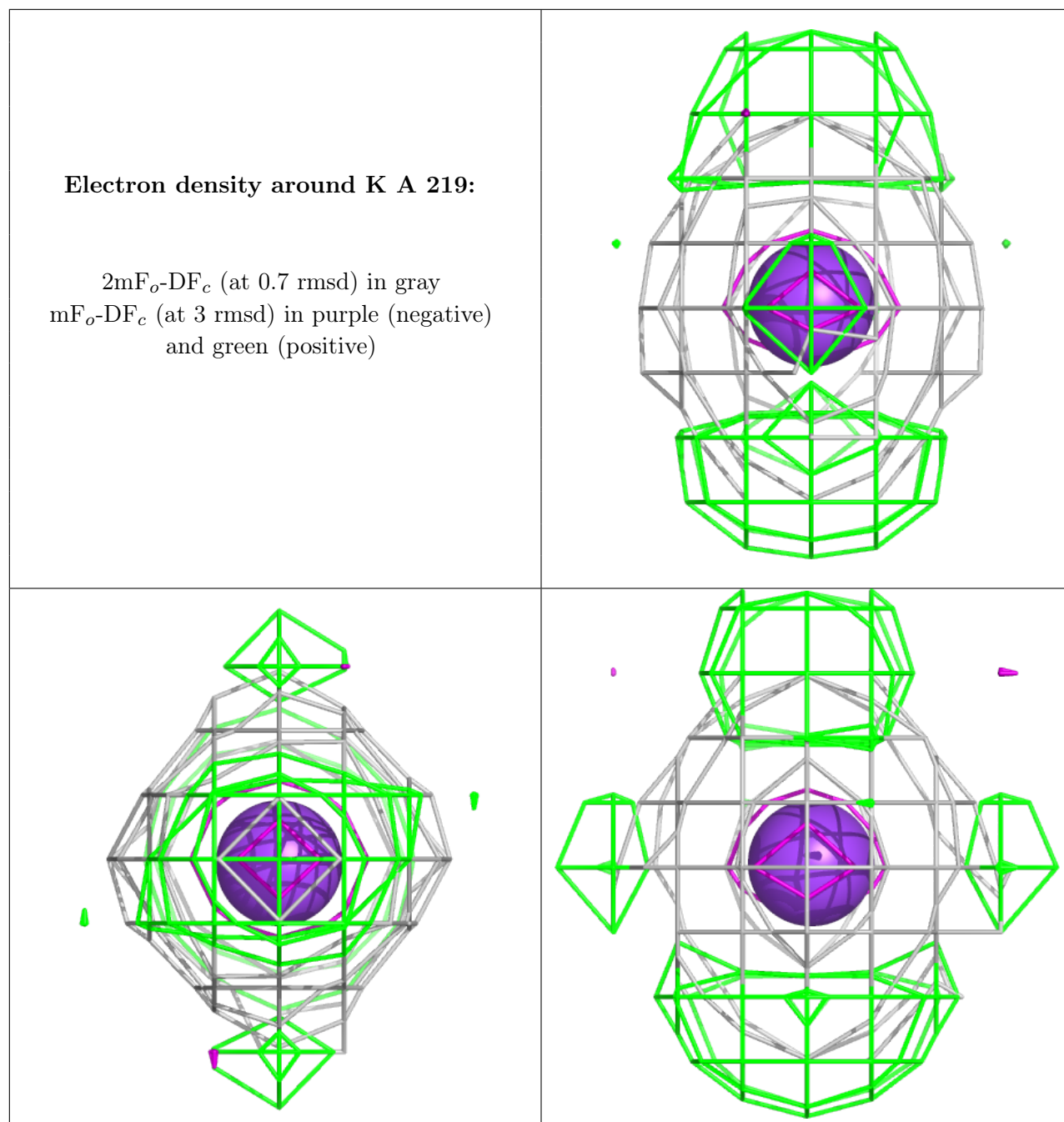

6.5 Other polymers [i](#)

There are no such residues in this entry.